

ADJUSTABLE PAVING SUPPORT SYSTEMS

FOR RAISED FLOORS

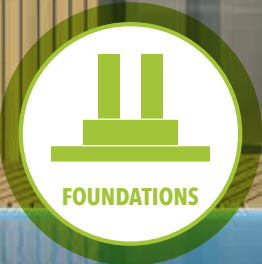

ELEMENTI NASCOSTI DELL'ARCHITETTURA





ITALPROFILI®

RESISTANT TO TIME

Tutti i nostri prodotti per l'edilizia sono studiati per aiutare architetti, progettisti e professionisti nella realizzazione di costruzioni impeccabili dal punto di vista tecnico ed estetico.

L'innovazione, la qualità e le materie prime contraddistinguono tutte le linee dei prodotti Italprofili:

- **Basamenti regolabili per pavimentazioni galleggianti**
- **Accessori per tetti**
- **Accessori per impermeabilizzanti cementizi e membrane liquide**
- **Accessori per fondazioni**

THE HIDDEN ELEMENTS OF ARCHITECTURE

All our construction products are designed to help architects, designers and professionals in the construction of impeccable buildings from a technical and aesthetic point of view.

Innovation, quality and raw materials distinguish all Italprofili ranges of products :

- **Adjustable paving support systems for raised floors**
- **Roofing accessories**
- **Accessories for cementitious waterproofings and liquid membranes**
- **Accessories for foundations**

ELEMENTOS OCULTOS DE LA ARQUITECTURA

Todos nuestros productos de construcción están diseñados para ayudar a arquitectos, diseñadores y profesionales en la construcción de obras impecables desde un punto de vista técnico y estético.

La innovación, la calidad y las materias primas distinguen todas las líneas de productos Italprofili:

- **Soportes regulables para suelos elevados**
- **Accesorios para cubiertas**
- **Accesorios para impermeabilizantes cementosos y membranas líquidas**
- **Accesorios para cimientos**



ACCESSORI E TECNOLOGIE PER PAVIMENTAZIONI GALLEGGIANTI

I supporti regolabili per pavimenti sono stati la nostra naturale evoluzione. Studiare soluzioni per l'edilizia che permettano di trasformare o semplificare la realizzazione di una struttura, rendendola ancora più efficiente e performante, è stata una sfida. Semplici, modulari e adattabili i supporti regolabili per pavimentazioni lasciano ampio spazio all'immaginazione e alla creatività.

ACCESSORIES AND TECHNOLOGIES FOR RAISED FLOORS

Adjustable paving support systems have been our natural evolution. Studying construction solutions that can transform or simplify the creation of a structure, making it more appealing and efficient, has been a challenge. Simple, modular and adaptable, our adjustable paving support systems leave room for imagination and creativity.

ACCESORIOS Y TECNOLOGÍAS PARA SUELOS ELEVADOS

Los soportes regulables para suelos han sido nuestra evolución natural. El estudio de soluciones para la construcción que transformen o simplifiquen la realización de una estructura, haciéndola aún más eficiente y prestacional, ha sido un reto. Sencillos, modulares y adaptables, los soportes regulables para suelos dejan amplio espacio a la imaginación y a la creatividad.





LIBERTÀ DI STILE

Versatilità e semplicità sono le parole che caratterizzano la scelta di una pavimentazione sopraelevata. Grazie al sistema di supporti si è liberi di cambiare e di giocare con materiali diversi per esaltare l'architettura dei diversi spazi. Utilizzati in nuove costruzioni, trovano il loro massimo impiego negli interventi di ristrutturazione.

FREEDOM OF STYLE

Versatility and simplicity are the keywords for choosing a raised floor. Thanks to the adjustable support systems, we are free to change and play with different materials in order to highlight the architecture of different spaces. They are used in new buildings and in renovation where they find their maximum employment.

LIBERTAD DE ESTILO

Versatilidad y simplicidad son las palabras que caracterizan la elección de un suelo elevado. Gracias al sistema de soportes, es posible cambiar y jugar con diferentes materiales para resaltar la arquitectura de los diferentes espacios. Utilizados en las nuevas construcciones, también son ideales para los trabajos de reestructuración.





TUTTI I BENEFICI

ALL THE ADVANTAGES

TODOS LOS BENEFICIOS



PORTATA

Struttura robusta e sicura grazie all'utilizzo di materie prime che oltre ad essere riciclabili al 100% garantiscono prestazioni uniche e durature.

LOAD CAPACITY

Strong and safe structure, thanks to the use of 100% recyclable raw materials that guarantee unique and lasting performances.

CAPACIDAD DE CARGA

Estructura robusta y segura gracias al uso de materias primas que además de ser 100 % reciclables garantizan un rendimiento único y duradero.



ISOLAMENTO

L'intercapedine tra piano di posa e pavimento finito consente di avere un'areazione costante, riducendo così gli sbalzi termici e fornendo un isolamento acustico.

INSULATION

The interspace between the laying surface and the finished floor allows a constant ventilation, thus reducing thermal changes and providing sound insulation.

AISLAMIENTO

El espacio entre la superficie de colocación y el suelo terminado permite una ventilación constante, reduciendo así el choque térmico y creando un aislamiento acústico.



MANUTENZIONE

Tubi e impianti che alloggiato tra pavimentazione e suolo risultano facilmente ispezionabili sollevando una porzione di pavimentazione.

MAINTENANCE

Pipes and plants that are located between the floor and the ground can be easily inspected by lifting a portion of the floor.

MANTENIMIENTO

Las tuberías y las instalaciones que se colocan entre el pavimento y el suelo se pueden inspeccionar fácilmente levantando una parte del suelo.

+ PLUS +

- PORTATA PESO
- ISOLAMENTO TERMICO
- ISOLAMENTO ACUSTICO
- MANUTENZIONE IMPIANTI
- CORREGGERE PENDENZE ESISTENTI
- CREARE DIVERSI LIVELLI
- CHIAVE DI REGOLAZIONE
- REGOLAZIONE DELL'ALTEZZA
ANCHE DA PAVIMENTO POSATO

+ ADVANTAGES +

- LOAD CAPACITY
- THERMAL INSULATION
- SOUND INSULATION
- MAINTENANCE OF UTILITY SYSTEMS
- CORRECTION OF EXISTING SLOPES
- CREATION OF DIFFERENT LEVELS
- REGULATING KEY
- HEIGHT ADJUSTMENT
EVEN WITH LAID FLOOR

+ VENTAJAS +

- CAPACIDAD PESO
- AISLAMIENTO TÉRMICO
- AISLAMIENTO ACÚSTICO
- MANTENIMIENTO DE INSTALACIONES
- CORREGIR PENDIENTES EXISTENTES
- CREAR DIFERENTES NIVELES
- LLAVE DE REGULACIÓN
- LLAVE DE REGULACIÓN DE LA ALTURA
INCLUSO CON EL SUELO COLOCADO



CORREGGERE PENDENZE

La regolazione a posa terminata permette di correggere leggeri dislivelli in maniera semplice ed efficace. Utilizzando la chiave di regolazione non è necessario sollevare piastrelle.

CORRECTION OF EXISTING SLOPES

The regulation after laying allows to correct slight differences in level in a simple and effective way. Using the regulating key is not necessary to lift tiles.

CORREGIR PENDIENTES

La regulación, una vez terminada la colocación, permite corregir de manera sencilla y eficaz ligeros desniveles. Utilizando la llave de regulación no es necesario levantar las baldosas.

PESO CONTENUTO

Le pavimentazioni vengono realizzate senza l'aggiunta di massetti di calcestruzzo contenendo il peso e favorendo l'ambiente.

CONTAINED WEIGHT

The raise floors are made without the addition of concrete screeds containing the weight and supporting the environment.

PESO REDUCIDO

Los suelos se realizan sin añadir soleras de hormigón, reduciendo así el peso y protegiendo el medio ambiente.

MATERIALI DUREVOLI

Il polipropilene utilizzato per tutti i nostri supporti è di prima scelta. Gli additivi che vengono aggiunti sono testati per conferire al prodotto la massima durata nel tempo anche esposti a condizioni climatiche non favorevoli.

DURABLE MATERIALS

For all our supports we use a high-quality polypropylene. The additives that are added are tested to give the product maximum duration even when exposed to unfavorable weather conditions.

MATERIALES DURADEROS

El propileno utilizado para todos nuestros soportes es de primera calidad. Los aditivos que se añaden son probados para proporcionar al producto la máxima durabilidad incluso cuando están expuesto a condiciones climáticas desfavorables.



DUALSYSTEM
EVOLUTION

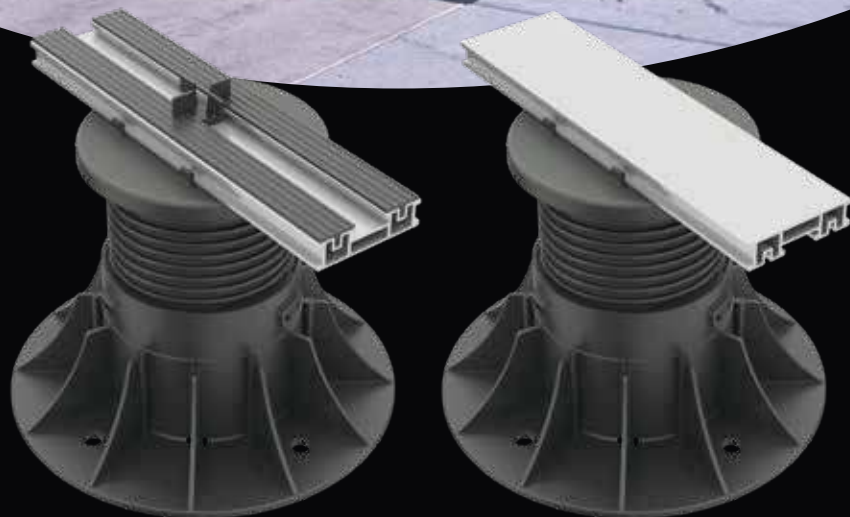



UNO TIRA L'ALTRO

Modulari e regolabili i supporti per pavimentazioni sopraelevate, grazie alle prolunghe si possono raggiungere altezze fino ad 1 metro; eliminando dislivelli e pendenze in qualsiasi spazio e soprattutto agevolando l'ispezione degli impianti.

ONE PULL THE OTHER

Modular and adjustable, the support systems for raised floors, thanks to the extensions can reach up 1 metre; eliminating differences and slopes in every space and especially facilitating the inspection of the plants.

UNO TRAS OTRO

Modulares y regulables, con los soportes para suelos elevados, gracias a las extensiones, se puede alcanzar una altura de hasta 1 metro, eliminando desniveles y pendientes en cualquier espacio y sobre todo facilitando la inspección de las instalaciones.



SPECIAL



**SPECIAL
LIGHT**



RAISE-UP



FIXED

SEMPLICI DA POSARE

Semplicemente appoggiandoli a terra sulla superficie da pavimentare o sulla membrana impermeabile assicurano un sostegno robusto, la loro portata infatti è tra le maggiori sul mercato. Tutti i nostri prodotti si adattano ad ambienti esterni con qualsiasi tipo di pavimentazione ceramica, cementizia e decking.

EASY TO LAY

Simply by placing them on the ground on the surface to be paved or on the waterproof membrane, they ensure a strong support; their load capacity is in fact among the largest on the market. All our products are suitable as outdoor environments with any type of ceramic, cementitious flooring and decking systems.

FÁCILES DE COLOCAR

Simplemente apoyándolos en el suelo, sobre la superficie que se debe pavimentar o sobre la membrana impermeable, aseguran un soporte robusto; de hecho, su capacidad de carga es una de las más grandes del mercado. Todos nuestros productos se adaptan a entornos exteriores con cualquier tipo de pavimento de cerámica, cemento y de tarima.



SEMPRE REGOLABILI

ALWAYS ADJUSTABLE

The Italprofili regulating key, designed to adapt to all models, excluding decking systems, allows to operate even when the work is finished, that is on the floor laid correcting the structure to the millimeter. All this without even lifting the flooring with incredible savings in terms of time.

SIEMPRE REGULABLES

La llave de regulación de Italprofili, diseñada para adaptarse a todos los modelos, con la excepción de los suelos de tarima, permite operar incluso cuando el trabajo está terminado, es decir, con el suelo colocado corrigiendo al milímetro la altura de la estructura. Todo esto sin siquiera levantar el suelo, con un increíble ahorro de tiempo.

La chiave di regolazione Italprofili, studiata per adattarsi a tutti i modelli, ad esclusione delle pavimentazioni decking, permette di operare anche a lavoro ultimato, cioè a pavimento posato correggendo l'altezza della struttura al millimetro. Tutto questo senza nemmeno sollevare la pavimentazione con un incredibile risparmio in termini di tempo.



DUAL SYSTEM EVOLUTION

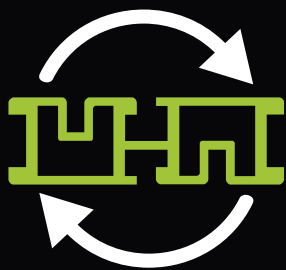

DUAL SYSTEM EVOLUTION



Dual System Evolution: unico prodotto, doppia soluzione. Il primo sistema a travetto adatto per l'utilizzo con pavimentazioni ceramiche e decking. La sua particolare conformazione permette di essere utilizzato per la posa di pavimentazioni ceramiche, con o senza profilo silenziatore antisdrucciolo ed elemento fuga orientabile 2 o 4 mm. Semplicemente ruotando il travetto di 180° si ottiene una superficie piana, perfetta per la posa di pavimentazioni decking. Il travetto Dual System Evolution è prodotto in alluminio estruso per garantire la massima durata nel tempo, un peso ridotto ed un'alta resistenza.

Disponibile in due versioni:

- 15 mm: lo spessore più basso disponibile nel mercato
- 25 mm: per una portata ancora più elevata

Dotato di aggancio rapido per il fissaggio alla testa del basamento, Dual System Evolution di Italprofili è disponibile per i basamenti della linea Special, Special Light e Raise-up.

Dual System Evolution: one product, double solution. The first joist system suitable for the use with ceramic and decking flooring. Its particular shape allows it to be used for laying ceramic flooring, with or without non-slip silencer profile and 2 or 4 mm adjustable spacer element. Simply turning the joist 180° you will get a flat surface, perfect for laying decking flooring.

The Dual System Evolution joist is made of extruded aluminium to ensure maximum durability, reduced weight and high resistance.

Available in two variations:

- 15 mm: the lowest thickness available on the market
- 25 mm: for an even higher load capacity

Equipped with quick coupling for fixing to the head of the support, Dual System Evolution by Italprofili is available for the Special, Special Light and Raise-up ranges of adjustable paving support systems.

Dual System Evolution: un único producto, una solución doble. El primer sistema de viga adaptado para la utilización con pavimentos cerámicos y de tarima. Su especial disposición permite utilizarlo para la puesta de pavimentos cerámicos, con o sin perfil de almohadilla antideslizante y elemento de junta orientable de 2 o 4 mm. Simplemente girando la viga 180° se obtiene una superficie plana, perfecta para la puesta de pavimentos de tarima. La viga Dual System Evolution está fabricada con aluminio extruido, garantiza la máxima duración a lo largo del tiempo, un peso reducido y una elevada resistencia.

Disponibile in dos versiones:

- 15 mm: el espesor más bajo disponible en el mercado
- 25 mm: para una carga aún más elevada

Dotado de enganche rápido para la fijación a la cabeza del soporte, Dual System Evolution de Italprofili está disponible para los soportes de la línea Special, Special Light y Raise-up.

I VANTAGGI DEL SISTEMA / THE ADVANTAGES OF THE SYSTEM / LAS VENTAJAS DEL SISTEMA



INSTALLAZIONE RAPIDA - EASY INSTALLATION - INSTALACIÓN RÁPIDA



ALTA RESISTENZA - HIGH RESISTANCE - ALTA RESISTENCIA

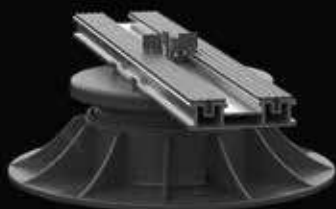

DURATA NEL TEMPO - RESISTANT TO TIME - DURACIÓN A LO LARGO DEL TIEMPO

TILE



DECKING



DIMENSIONI RIDOTTE - SMALL SIZES - DIMENSIONES REDUCIDAS



SISTEMI PER PAVIMENTAZIONI SOPRAELEVATE DA ESTERNO
SYSTEMS FOR RAISED FLOORS FOR EXTERIORS
SISTEMAS PARA SUELOS ELEVADOS PARA EXTERIORES

SPECIAL DUAL SYSTEM EVOLUTION CON TESTA AUTOLIVELLANTE

SPECIAL DUAL SYSTEM EVOLUTION WITH SELF-LEVELING HEAD

SPECIAL DUAL SYSTEM EVOLUTION CON CABEZA AUTONIVELANTE

**BASAMENTO REGOLABILE
ADJUSTABLE PAVING SUPPORT
SOPORTE REGULABLE**

Art. 185DSE	40 ÷ 56 mm
Art. 185.1DSE	50 ÷ 70 mm
Art. 185.2DSE	70 ÷ 110 mm
Art. 185.3DSE	110 ÷ 160 mm
Art. 185.4DSE	150 ÷ 210 mm
Art. 185.5DSE	200 ÷ 300 mm
Art. 185.6DSE	300 ÷ 400 mm
Art. 185.7DSE	400 ÷ 500 mm
Art. 185.8DSE	500 ÷ 600 mm
Art. 185.9DSE	600 ÷ 700 mm
Art. 185.10DSE	700 ÷ 800 mm
Art. 185.11DSE	800 ÷ 900 mm
Art. 185.12DSE	900 ÷ 1.000 mm

TESTA SPECIAL AUTOLIVELLANTE DUAL SYSTEM EVOLUTION
SELF-LEVELING HEAD SPECIAL DUAL SYSTEM EVOLUTION
CABEZA SPECIAL AUTONIVELANTE DUAL SYSTEM EVOLUTION



Art. 186DSE

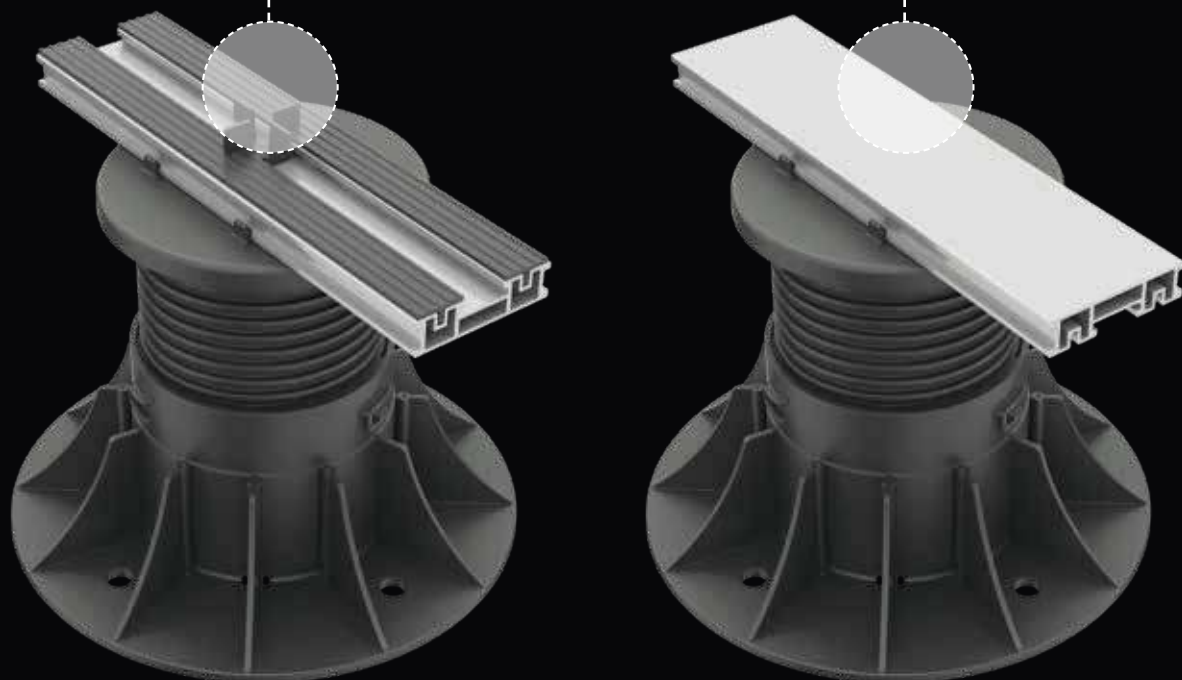

TESTA SPECIAL AUTOLIVELLANTE DUAL SYSTEM EVOLUTION SELF-LEVELING HEAD SPECIAL DUAL SYSTEM EVOLUTION CABEZA SPECIAL AUTONIVELANTE DUAL SYSTEM EVOLUTION

Testa Special autolivellante Dual System Evolution, dotata di 4 agganci per l'installazione rapida del travetto in alluminio Dual System Evolution.

Self-leveling head Special Dual System Evolution, equipped with 4 couplings for quick installation of the Dual System Evolution aluminum joist.

Cabeza Special autonivelante Dual System Evolution, dotada de 4 enganches para la instalación rápida de la viga de aluminio Dual System Evolution.

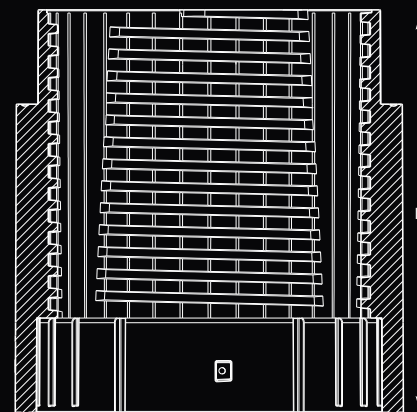
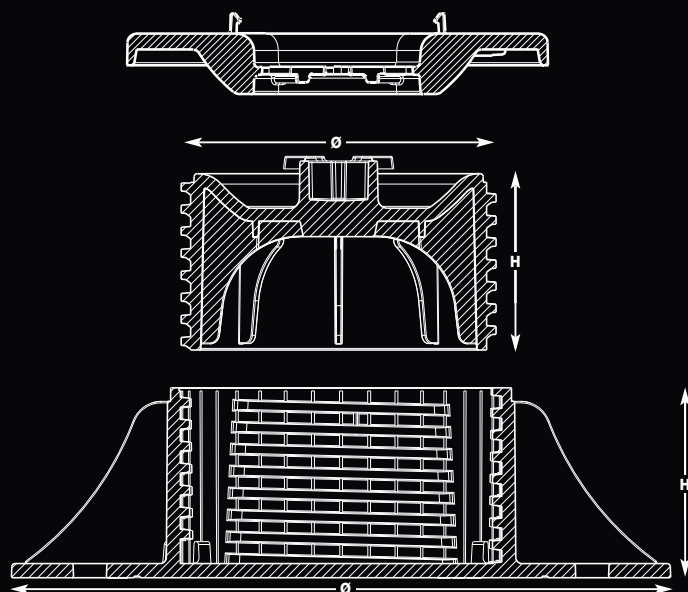
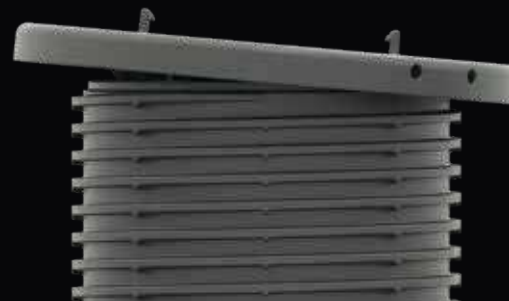

COMPOSIZIONE BASAMENTI REGOLABILI SPECIAL DUAL SYSTEM EVOLUTION / COMPOSITION OF ADJUSTABLE SUPPORTS SPECIAL DUAL SYSTEM EVOLUTION / COMPOSICIÓN SOPORTES REGULABLES SPECIAL DUAL SYSTEM EVOLUTION											
ARTICOLO CODE ART. ARTÍCULO	MISURE SIZE MEDIDAS		BASE BASE BASE		VITE FILETTATA THREADED SCREW TORNILLO ROSCADO		PROLUNGA A MANICOTTO THREADED EXTENSION EXTENSIÓN CON MANGUITO		TESTA AUTO LIVELLANTE SELF-LEVELING HEAD CABEZA AUTONIVELANTE		
codice code código	da mm. from mm. de mm.	a mm. to mm. a mm.	Ø mm.	h. mm.	Ø mm.	h. mm.	pezzi n. pieces n. cant. piezas	h. mm.	Ø mm.	h. mm.	livellamento max % max slope % nivelación máx. %
185DSE	40	56	210	30	101.8	26			130	6	± 9
185.1DSE	50	70	210	40	101.8	36			130	6	± 9
185.2DSE	70	110	210	60	101.8	56			130	6	± 9
185.3DSE	110	160	220	90	101.8	86			130	6	± 9
185.4DSE	150	210	220	90	101.8	136			130	6	± 9
185.5DSE	200	300	220	90	101.8	136	1	130	130	6	± 9
185.6DSE	300	400	220	90	101.8	136	2	130	130	6	± 9
185.7DSE	400	500	220	90	101.8	136	3	130	130	6	± 9
185.8DSE	500	600	220	90	101.8	136	4	130	130	6	± 9
185.9DSE	600	700	220	90	101.8	136	5	130	130	6	± 9
185.10DSE	700	800	220	90	101.8	136	6	130	130	6	± 9
185.11DSE	800	900	220	90	101.8	136	7	130	130	6	± 9
185.12DSE	900	1.000	220	90	101.8	136	8	130	130	6	± 9

Per garantire la portata e la perfetta efficienza del sistema di regolazione, si raccomanda di non oltrepassare la misura massima dichiarata nella descrizione del prodotto.

In order to guarantee the perfect efficiency of the regulation system, it is highly recommended not to exceed the maximum height indicated in the product description.

Para garantizar la capacidad de carga y la perfecta eficiencia del sistema de regulación, se recomienda no superar la medida máxima indicada en la descripción del producto.

TRAVETTO DUAL SYSTEM EVOLUTION

DUAL SYSTEM EVOLUTION JOIST

VIGA DUAL SYSTEM EVOLUTION

Il travetto Dual System Evolution può essere utilizzato come prodotto unico per la posa di pavimentazioni ceramiche e decking.

Prodotto in alluminio estruso, garantisce la massima durata nel tempo, un peso ridotto ed un'alta resistenza.

Disponibile in due versioni:

- 15 mm: lo spessore più basso disponibile nel mercato.
- 25 mm: per una portata ancora più elevata.

The Dual System Evolution joist can be used as a single product for laying ceramic and decking flooring. Produced in extruded aluminum, it guarantees maximum durability, reduced weight and high resistance.

It is available in two variations:

- 15 mm: the lowest thickness available on the market.
- 25 mm: for an even higher load capacity.

La viga Dual System Evolution puede utilizarse como producto único para la puesta de pavimentos cerámicos y de tarima.

Fabricada en aluminio extruido, garantiza la máxima duración a lo largo del tiempo, un peso reducido y una elevada resistencia.

Disponibile en dos versiones:

- 15 mm: el espesor más bajo disponible en el mercado.
- 25 mm: para una carga aún más elevada.

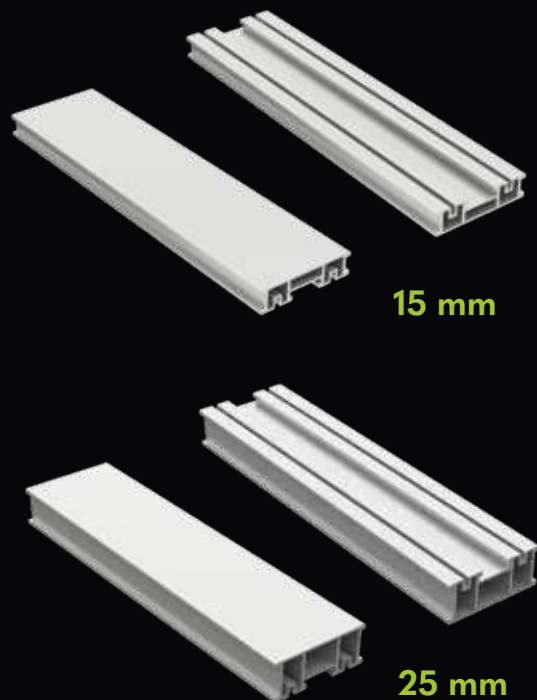

15 mm

25 mm

SISTEMA GIUNZIONE TRAVETTO JOIST JOINT SYSTEM SISTEMA UNIÓN VIGA

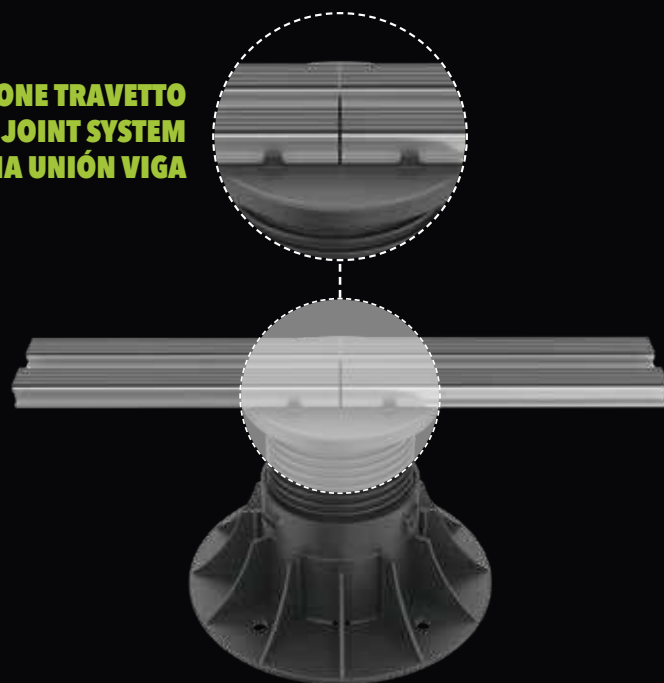

Art. 6215DSE



Art. 6225DSE

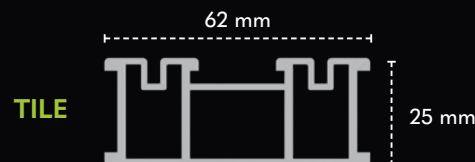

ARTICOLI OPZIONALI PER TRAVETTO DUAL SYSTEM EVOLUTION

OPTIONAL ITEMS FOR DUAL SYSTEM EVOLUTION JOIST

ARTÍCULOS OPCIONALES PARA VIGA DUAL SYSTEM EVOLUTION

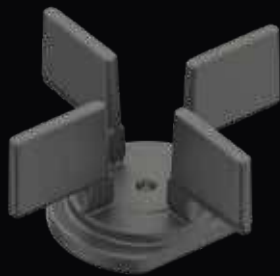
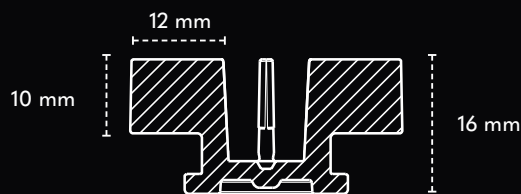

Art. XDSE.02

ELEMENTO FUGA DUAL SYSTEM EVOLUTION 2 MM. - SPACER ELEMENT DUAL SYSTEM EVOLUTION 2 MM. - ELEMENTO JUNTA DUAL SYSTEM EVOLUTION 2 MM.

Art. XDSE.04

ELEMENTO FUGA DUAL SYSTEM EVOLUTION 4 MM. - SPACER ELEMENT DUAL SYSTEM EVOLUTION 4 MM. - ELEMENTO JUNTA DUAL SYSTEM EVOLUTION 4 MM.

Elemento fuga, disponibile da 2 o 4 mm, studiato appositamente per distanziare gli elementi della pavimentazione; garantisce un appoggio totale della pavimentazione sul travetto.

Spacer element, available in 2 or 4 mm, specially designed to space out the elements of the flooring; guarantees total support of the paving on the joist.

Elemento junta, disponibile in 2 o 4 mm, estudiado especialmente para separar los elementos del pavimento; garantiza un apoyo total del pavimento en la viga.

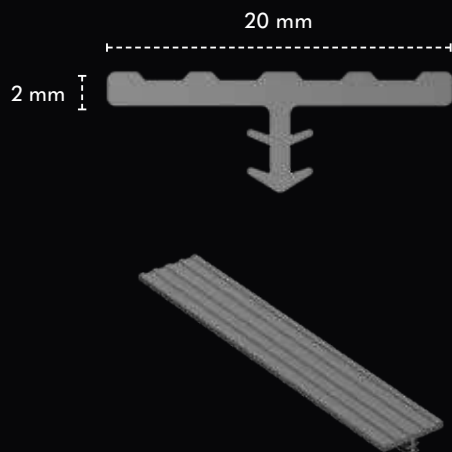

Art. SIL.DSE

PROFILO SILENZIATORE ANTISDRUCCIOLO PER TRAVETTO DUAL SYSTEM EVOLUTION - NON-SLIP SILENCER PROFILE FOR DUAL SYSTEM EVOLUTION JOIST - PERFIL DE ALMOHADILLA ANTIDESLIZANTE PARA VIGA DUAL SYSTEM EVOLUTION

Il profilo silenziatore per il travetto Dual System Evolution è prodotto in gomma fonoassorbente. Viene inserito nelle apposite guide del travetto abbattendo così il rumore derivante dal calpestio e creando un effetto antisdrucciolo.

The silencer profile for the Dual System Evolution joist is made of sound-absorbing rubber. It is inserted into the special guides of the joist thus reducing the noise deriving from trampling and creating a non-slip effect.

El perfil de almohadilla para la viga Dual System Evolucion está fabricado con goma fonoabsorbente. Se introduce en las relativas guías de la viga eliminando el ruido derivado de las pisadas y creando un efecto antideslizante.

ARTICOLI OPZIONALI PER **SISTEMA SPECIAL** **DUAL SYSTEM EVOLUTION**

OPTIONAL ITEMS FOR SPECIAL DUAL SYSTEM EVOLUTION

ARTÍCULOS OPCIONALES PARA SISTEMA DUAL SYSTEM EVOLUTION

Art. 186.4

**PROLUNGA A MANICOTTO - SLEEVE
EXTENSION - EXTENSIÓN CON MANGUITO**

La prolunga manicotto è applicabile solo su Art. 185.4DSE e consente di raggiungere altezze fino ad 1 metro e oltre, mantenendo un range di regolazione finale di 100 mm.

The sleeve extension is applicable on Art. 185.4DSE and allows to reach heights up to 1 metre and above, maintaining a final adjustment of 100 mm.

La extensión con manguito solo se aplica en el Art. 185.4DSE y permite alcanzar alturas de hasta 1 metro y más, manteniendo un rango de regulación final de 100 mm.



Art. 186.6

**CHIAVE DI REGOLAZIONE ITALPROFILI 50 CM
ITALPROFILI REGULATING KEY 50 CM
LLAVE DE REGULACIÓN ITALPROFILI 50 CM**

Chiave di regolazione l. 500 mm., utilizzabile a pavimentazione ultimata con fughe 4 - 6 - 8 - 10 mm.

Regulating key l. 500 mm., used for paving completed with 4 - 6 - 8 - 10 mm spacers.

Llave de regulación de 500 mm. de largo, que se utiliza con el suelo terminado con juntas de 4 - 6 - 8 - 10 mm.

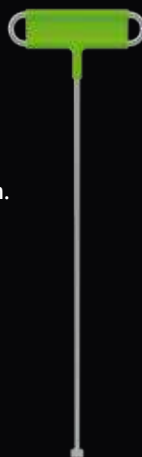

Art. 190

**PINZA POSAPIASTRE PER PIASTRE
DI LATO 30 - 35 - 40 - 45 - 50 CM
PAVING SLAB HANDLER 30 - 35 - 40 - 45 - 50 CM
PINZA ESPESORADA PARA LOSAS DE 30 - 35 - 40 -
45 - 50 CM DE LADO**



Art. 186.6 C

**CHIAVE DI REGOLAZIONE ITALPROFILI 25 CM
ITALPROFILI REGULATING KEY 25 CM
LLAVE DE REGULACIÓN ITALPROFILI 25 CM**

Chiave di regolazione l. 250 mm., utilizzabile a pavimentazione ultimata con fughe 4 - 6 - 8 - 10 mm.

Regulating key l. 250 mm., used for paving completed with 4 - 6 - 8 - 10 mm spacers.

Llave de regulación de 250 mm. de largo, que se utiliza con el suelo terminado con juntas de 4 - 6 - 8 - 10 mm.



Art. 195

**VENTOSA ALZAPIASTRELLE 110KG
SUCTION CUP TILE LIFTER 110KG
VENTOSA SUBIDA BALDOSAS 110 KG**



Art. 186.5

SPESSORE LIVELLANTE - LEVELING SPACER - ESPESOR NIVELANTE

Lo spessore livellante da 1,5 a 5 mm. può essere usato interamente, è impilabile o sezionabile per 1/2 o 1/4. Viene impiegato nei casi in cui la superficie di appoggio sia molto irregolare o per colmare i dislivelli creati dai sormonti del manto impermeabile. Può essere utilizzato anche per aumentare l'altezza finale del basamento di 5 mm.

The leveling spacer, from 1,5 to 5 mm, can be used as a whole, and can also be stacked or sectioned by 1/2 or 1/4. These components are used when the support surface is extremely irregular or to compensate for the differences in level created by overlaps in the waterproofing layer. It can also be used to increase the final height with 5 mm.

El espesor nivelante de 1,5 a 5 mm se puede utilizar por completo, apilar o cortar por 1/2 o 1/4. Se utiliza cuando la superficie de apoyo es muy irregular o para colmar los desniveles creados por el solapado de la membrana impermeable. También se puede utilizar para aumentar 5 mm la altura final del soporte.



ART. 185DP2 - 185DP4

DISTANZIALE PERIMTRALE INOX FUGA 2/4 mm - PERIMETRAL SPACER STAINLESS STEEL FOR HEAD SPACER 2/4 mm - DILATADOR PERIMETRAL ACERO INOX JUNTA 2/4 mm

Il distanziale perimetrale viene posato direttamente sopra la testa permettendo di tenere distanziata di 5 mm. la pavimentazione dal perimetro verticale di contenimento. Opportunamente sagomato per evitare lo sfregamento della pavimentazione sul perimetro verticale di contenimento ed assorbire eventuali movimenti e dilatazioni della pavimentazione. Realizzato in acciaio inox, spessore di 0,8 mm.

The perimetral spacer is laid directly on the head allowing to keep the flooring of a distance of 5 mm from the vertical containment perimeter. Suitably shaped to avoid the rubbing of the pavement on the vertical containment perimeter and to absorb any movement and expansion of the pavement. Made of stainless steel, 0,8 mm thick.

El dilatador perimetral se coloca directamente sobre la cabeza, permitiendo mantener el pavimento a 5 mm de distancia del perímetro vertical de contención. Tiene una forma adecuada para evitar que el pavimento frote sobre el perímetro vertical de contención y para absorber posibles movimientos y dilataciones del pavimento. Está hecho de acero inoxidable de 0,8 mm de espesor.



Art. 185CV2 - 185CV4

SET CLIP CHIUSURA VERTICALI FUGA 2/4 mm
SET CLIP FOR VERTICAL CLOSURE SPACER 2/4 mm
JUEGO DE CERRAMIENTOS VERTICALES JUNTA 2/4 mm

I set clip chiusura verticali Italprofili sono studiati per dare un aggancio robusto ed esteticamente gradevole alle chiusure dei bordi perimetrali verticali nelle pavimentazioni sopraelevate, creando così un contenimento perimetrale per la pavimentazione. Realizzate in acciaio inox spessore 0,8 mm. sono disponibili con fuga 2 o 4 mm.

The Italprofili set clip for vertical closure is designed to give a strong and aesthetically pleasing attachment to the closing of the vertical perimeter edges in raised floors, thus creating a perimeter containment for the flooring. Made of 0,8 mm thick stainless steel, they are available with 2 or 4 mm spacers.

Los juegos de cerramientos verticales Italprofili están diseñados para un enganche fuerte y estéticamente agradable en los remates de los bordes perimetrales verticales en los suelos elevados, creando así una contención perimetral para el pavimento. Hechos de acero inoxidable de 0,8 mm de espesor, están disponibles con juntas de 2 o 4 mm.

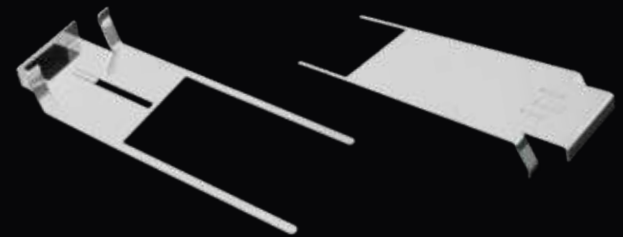

VOCE DI CAPITOLATO DEL SISTEMA SPECIAL DUAL SYSTEM EVOLUTION DESCRIPTION FOR SPECIFICATIONS OF THE SPECIAL DUAL SYSTEM EVOLUTION ESPECIFICACIONES TÉCNICAS DEL SISTEMA SPECIAL DUAL SYSTEM EVOLUTION

SPECIAL DUAL SYSTEM EVOLUTION

Fornitura e posa in opera di basamenti regolabili del tipo Italprofili linea Special, modello Dual System Evolution in polipropilene, per la realizzazione di pavimentazioni sopraelevate per esterno, con finitura ceramica, decking o legno.

Il sistema è composto da:

- Basamento Special Dual System Evolution (base e vite filettate).
- Testa Special autolivellante Dual System Evolution con aggancio rapido per travetto.
- Travetto in alluminio Dual System Evolution disponibile in due versioni: mm. 62x15 l. 2000 o mm. 62x25 l. 2000.
- Profilo silenziatore in gomma Dual System Evolution ad innesto rapido (solo per finitura ceramica).
- Elemento fuga Dual System Evolution da 2 o 4 mm (solo per finitura ceramica).

SPECIAL DUAL SYSTEM EVOLUTION

Supply and installation of adjustable Special paving supports Dual System Evolution made of polypropylene, for the realisation of raised floors for exteriors with ceramic, decking or wood.

The system consists of:

- Special paving support Dual System Evolution (threaded base and screw).
- Self-leveling head Special Dual System Evolution with quick coupling for the joist.
- Aluminium joist Dual System Evolution available in two variations: mm. 62x15 l. 2000 or mm. 62x25 l. 2000.
- Non-slip silencer profile Dual System Evolution made of rubber with quick coupling (only for ceramic flooring).
- Spacer element Dual System Evolution 2 or 4 mm. (only for ceramic flooring).

SPECIAL DUAL SYSTEM EVOLUTION

Suministro y puesta en obra de soportes regulables de tipo Italprofili línea Special, modelo Dual System Evolution de polipropileno, para la realización de suelos elevados para exterior, con acabado cerámico, de tarima o madera.

El sistema se compone de:

- Soporte Special Dual System Evolution (base y tornillo roscado).
- Cabeza Special autonivelante Dual System Evolution con enganche rápido para viga.
- Viga de aluminio Dual System Evolution disponible en dos versiones: mm. 62x15 l. 2000 o mm. 62x25 l. 2000.
- Perfil de almohadilla de goma Dual System Evolution de acople rápido (solo para acabado cerámico).
- Elemento junta Dual System Evolution de 2 o 4 mm (solo para acabado cerámico).

SISTEMI PER PAVIMENTAZIONI SOPRAELEVATE DA ESTERNO
SYSTEMS FOR RAISED FLOORS FOR EXTERIORS
SISTEMAS PARA SUELOS ELEVADOS PARA EXTERIORES

SPECIAL FH DUAL SYSTEM EVOLUTION CON TESTA FISSA

SPECIAL FH DUAL SYSTEM EVOLUTION WITH FIXED HEAD

SPECIAL FH DUAL SYSTEM EVOLUTION CON CABEZA FIJA

BASAMENTO REGOLABILE
ADJUSTABLE PAVING SUPPORT
SOPORTE REGULABLE

Art. 185.FHDSE	40 ÷ 56 mm
Art. 185.1FHDSE	50 ÷ 70 mm
Art. 185.2FHDSE	70 ÷ 110 mm
Art. 185.3FHDSE	110 ÷ 160 mm
Art. 185.4FHDSE	150 ÷ 210 mm
Art. 185.5FHDSE	200 ÷ 300 mm
Art. 185.6FHDSE	300 ÷ 400 mm
Art. 185.7FHDSE	400 ÷ 500 mm
Art. 185.8FHDSE	500 ÷ 600 mm
Art. 185.9FHDSE	600 ÷ 700 mm
Art. 185.10FHDSE	700 ÷ 800 mm
Art. 185.11FHDSE	800 ÷ 900 mm
Art. 185.12FHDSE	900 ÷ 1.000 mm

TESTA SPECIAL FISSA DUAL SYSTEM EVOLUTION
FIXED HEAD SPECIAL DUAL SYSTEM EVOLUTION
CABEZA SPECIAL FIJA DUAL SYSTEM EVOLUTION



Art. 186FDSE

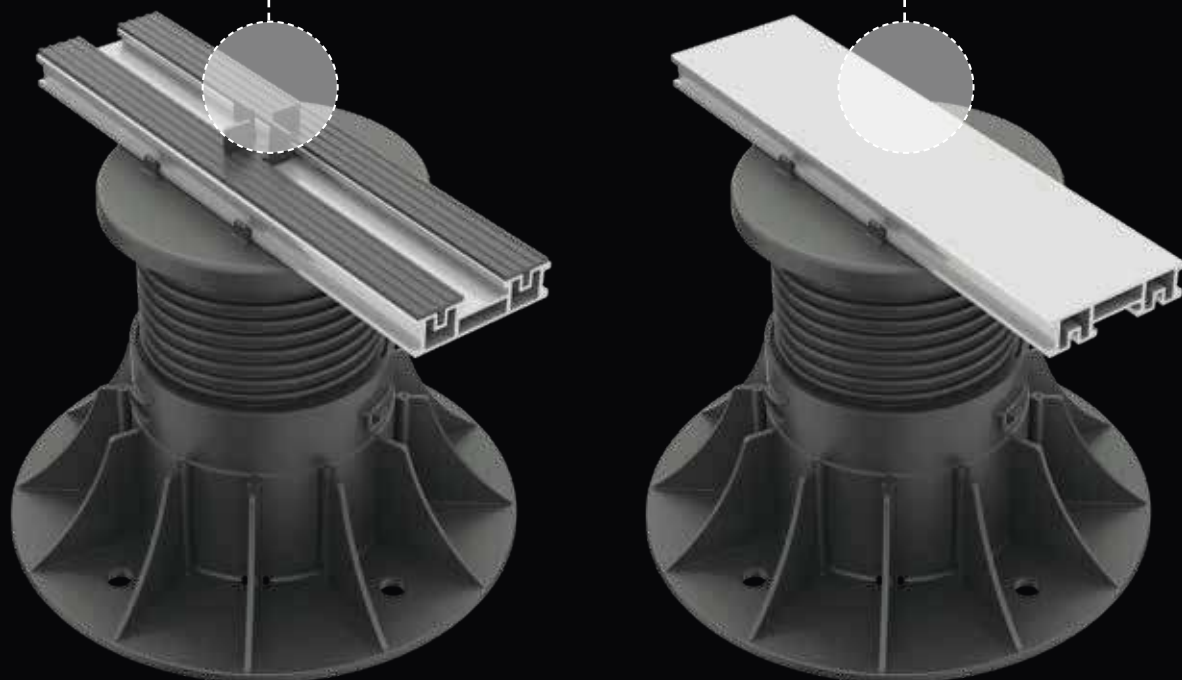

TESTA SPECIAL FISSA DUAL SYSTEM EVOLUTION FIXED HEAD SPECIAL DUAL SYSTEM EVOLUTION CABEZA SPECIAL FIJA DUAL SYSTEM EVOLUTION

Testa Special fissa Dual System Evolution, dotata di 4 agganci per l'installazione rapida del travetto in alluminio Dual System Evolution.

Fixed head Special Dual System Evolution, equipped with 4 couplings for quick installation of the Dual System Evolution aluminum joist.

Cabeza Special fija Dual System Evolution, dotada de 4 enganches para la instalación rápida de la viga de aluminio Dual System Evolution.

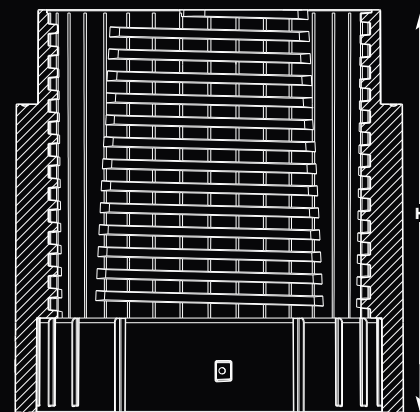
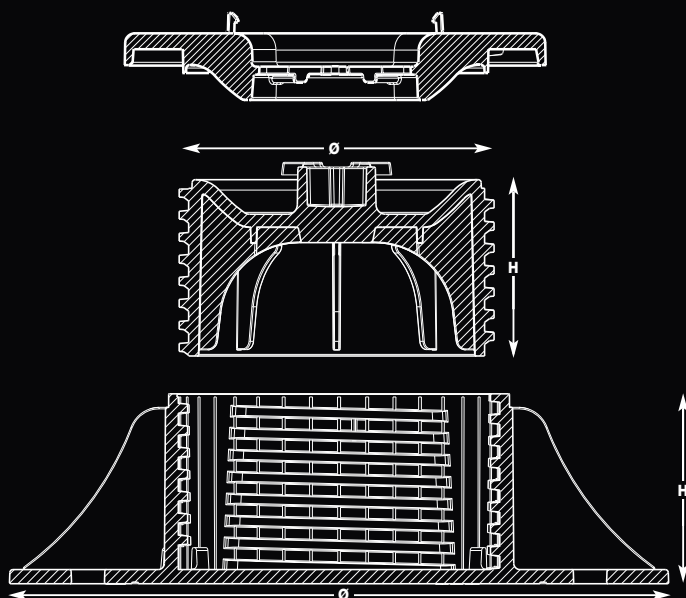
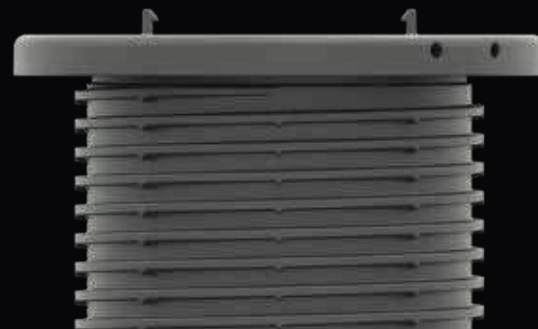

COMPOSIZIONE BASAMENTI REGOLABILI SPECIAL FH DUAL SYSTEM EVOLUTION / COMPOSITION OF ADJUSTABLE SUPPORTS SPECIAL FH DUAL SYSTEM EVOLUTION / COMPOSICIÓN SOPORTES REGULABLES SPECIAL FH DUAL SYSTEM EVOLUTION										
ARTICOLO CODE ART ARTÍCULO	MISURE SIZE MEDIDAS		BASE BASE BASE		VITE FILETTATA THREADED SCREW TORNILLO ROSCADO		PROLUNGA A MANICOTTO THREADED EXTENSION EXTENSIÓN CON MANGUITO		TESTA FISSA FIXED HEAD CABEZA FIJA	
codice code código	da mm. from mm. de mm.	a mm. to mm. a mm.	Ø mm.	h. mm.	Ø mm.	h. mm.	pezzi n. pieces n. cant. piezas	h. mm.	Ø mm.	h. mm.
185FH	40	56	210	30	101.8	26			130	6
185.1FH	50	70	210	40	101.8	36			130	6
185.2FH	70	110	210	60	101.8	56			130	6
185.3FH	110	160	220	90	101.8	86			130	6
185.4FH	150	210	220	90	101.8	136			130	6
185.5FH	200	300	220	90	101.8	136	1	130	130	6
185.6FH	300	400	220	90	101.8	136	2	130	130	6
185.7FH	400	500	220	90	101.8	136	3	130	130	6
185.8FH	500	600	220	90	101.8	136	4	130	130	6
185.9FH	600	700	220	90	101.8	136	5	130	130	6
185.10FH	700	800	220	90	101.8	136	6	130	130	6
185.11FH	800	900	220	90	101.8	136	7	130	130	6
185.12FH	900	1.000	220	90	101.8	136	8	130	130	6

Per garantire la portata e la perfetta efficienza del sistema di regolazione, si raccomanda di non oltrepassare la misura massima dichiarata nella descrizione del prodotto.

In order to guarantee the perfect efficiency of the regulation system, it is highly recommended not to exceed the maximum height indicated in the product description.

Para garantizar la capacidad de carga y la perfecta eficiencia del sistema de regulación, se recomienda no superar la medida máxima indicada en la descripción del producto.

TRAVETTO DUAL SYSTEM EVOLUTION

DUAL SYSTEM EVOLUTION JOIST

VIGA DUAL SYSTEM EVOLUTION

Il travetto Dual System Evolution può essere utilizzato come prodotto unico per la posa di pavimentazioni ceramiche e decking.

Prodotto in alluminio estruso, garantisce la massima durata nel tempo, un peso ridotto ed un'alta resistenza.

Disponibile in due versioni:

- 15 mm: lo spessore più basso disponibile nel mercato.
- 25 mm: per una portata ancora più elevata.

The Dual System Evolution joist can be used as a single product for laying ceramic and decking flooring. Produced in extruded aluminum, it guarantees maximum durability, reduced weight and high resistance.

It is available in two variations:

- 15 mm: the lowest thickness available on the market.
- 25 mm: for an even higher load capacity.

La viga Dual System Evolution puede utilizarse como producto único para la puesta de pavimentos cerámicos y de tarima.

Fabricada en aluminio extruido, garantiza la máxima duración a lo largo del tiempo, un peso reducido y una elevada resistencia.

Disponibile en dos versiones:

- 15 mm: el espesor más bajo disponible en el mercado.
- 25 mm: para una carga aún más elevada.

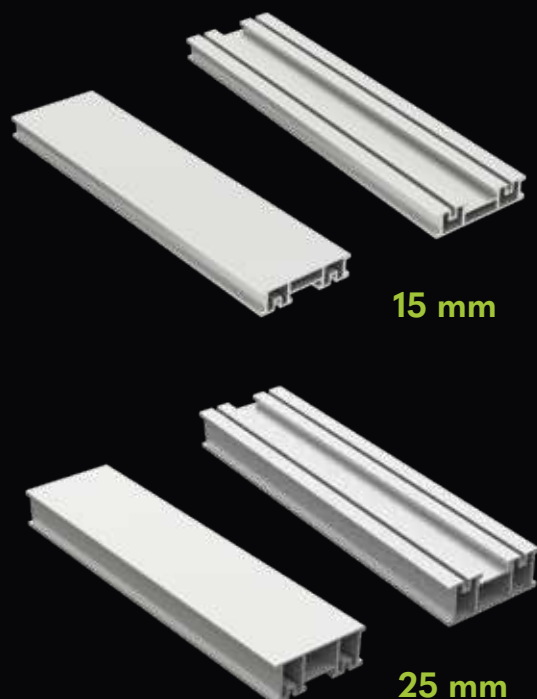

15 mm

25 mm

SISTEMA GIUNZIONE TRAVETTO JOIST JOINT SYSTEM SISTEMA UNIÓN VIGA

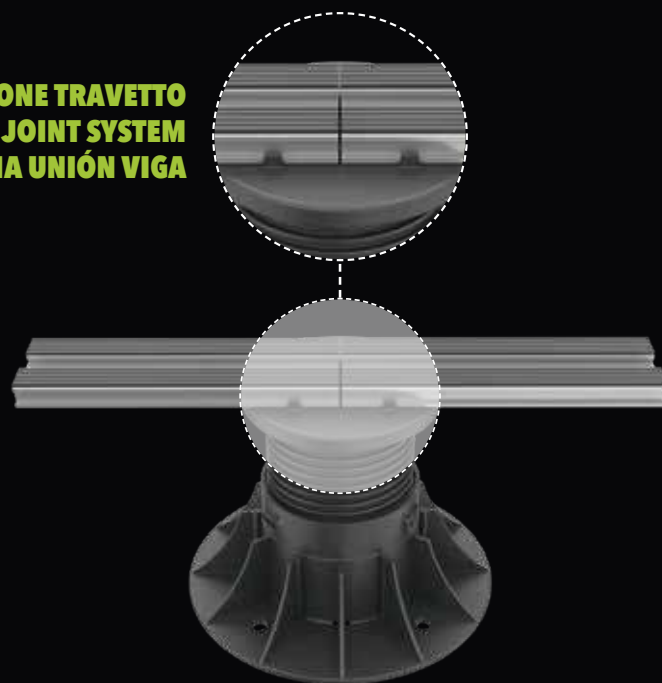

Art. 6215DSE

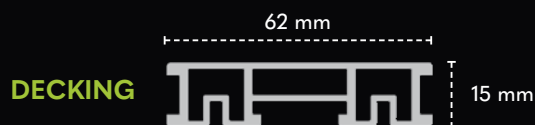

Art. 6225DSE

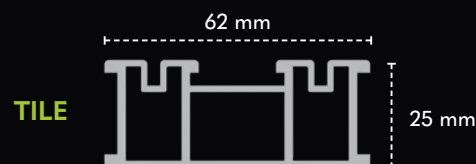

ARTICOLI OPZIONALI PER TRAVETTO DUAL SYSTEM EVOLUTION

OPTIONAL ITEMS FOR DUAL SYSTEM EVOLUTION JOIST

ARTÍCULOS OPCIONALES PARA VIGA DUAL SYSTEM EVOLUTION

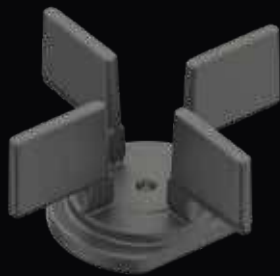
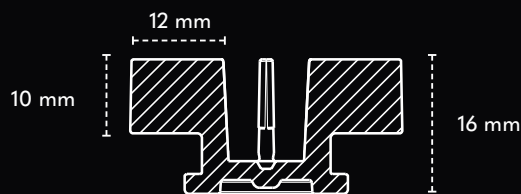

Art. XDSE.02

ELEMENTO FUGA DUAL SYSTEM EVOLUTION 2 MM. - SPACER ELEMENT DUAL SYSTEM EVOLUTION 2 MM. - ELEMENTO JUNTA DUAL SYSTEM EVOLUTION 2 MM.

Art. XDSE.04

ELEMENTO FUGA DUAL SYSTEM EVOLUTION 4 MM. - SPACER ELEMENT DUAL SYSTEM EVOLUTION 4 MM. - ELEMENTO JUNTA DUAL SYSTEM EVOLUTION 4 MM.

Elemento fuga, disponibile da 2 o 4 mm, studiato appositamente per distanziare gli elementi della pavimentazione; garantisce un appoggio totale della pavimentazione sul travetto.

Spacer element, available in 2 or 4 mm, specially designed to space out the elements of the flooring; guarantees total support of the paving on the joist.

Elemento junta, disponibile in 2 o 4 mm, estudiado especialmente para separar los elementos del pavimento; garantiza un apoyo total del pavimento en la viga.

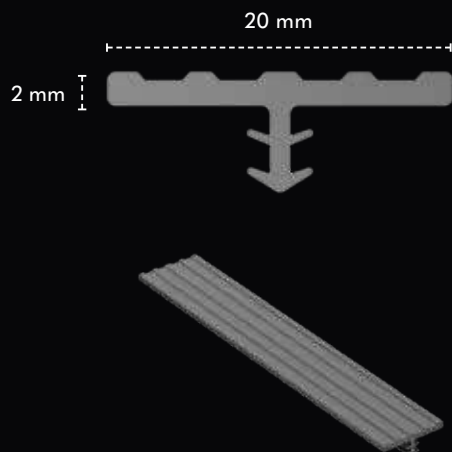

Art. SIL.DSE

PROFILO SILENZIATORE ANTISDRUCCIOLO PER TRAVETTO DUAL SYSTEM EVOLUTION - NON-SLIP SILENCER PROFILE FOR DUAL SYSTEM EVOLUTION JOIST - PERFIL DE ALMOHADILLA ANTIDESLIZANTE PARA VIGA DUAL SYSTEM EVOLUTION

Il profilo silenziatore per il travetto Dual System Evolution è prodotto in gomma fonoassorbente. Viene inserito nelle apposite guide del travetto abbattendo così il rumore derivante dal calpestio e creando un effetto antisdrucciolo.

The silencer profile for the Dual System Evolution joist is made of sound-absorbing rubber. It is inserted into the special guides of the joist thus reducing the noise deriving from trampling and creating a non-slip effect.

El perfil de almohadilla para la viga Dual System Evolucion está fabricado con goma fonoabsorbente. Se introduce en las relativas guías de la viga eliminando el ruido derivado de las pisadas y creando un efecto antideslizante.

ARTICOLI OPZIONALI PER **SISTEMA SPECIAL FH** **DUAL SYSTEM EVOLUTION**

OPTIONAL ITEMS FOR SPECIAL FH DUAL SYSTEM EVOLUTION

ARTÍCULOS OPCIONALES PARA SISTEMA SPECIAL FH DUAL SYSTEM EVOLUTION

Art. 186.4

**PROLUNGA A MANICOTTO - SLEEVE
 EXTENSION - EXTENSIÓN CON MANGUITO**

La prolunga manicotto è applicabile solo su Art. 185.4FHDSE e consente di raggiungere altezze fino ad 1 metro e oltre, mantenendo un range di regolazione finale di 100 mm.

The sleeve extension is applicable on Art. 185.4FHDSE and allows to reach heights up to 1 metre and above, maintaining a final adjustment of 100 mm.

La extensión con manguito solo se aplica en el Art. 185.4FHDSE y permite alcanzar alturas de hasta 1 metro y más, manteniendo un rango de regulación final de 100 mm.



Art. 186.6

**CHIAVE DI REGOLAZIONE ITALPROFILI 50 CM
 ITALPROFILI REGULATING KEY 50 CM
 LLAVE DE REGULACIÓN ITALPROFILI 50 CM**

Chiave di regolazione l. 500 mm., utilizzabile a pavimentazione ultimata con fughe 4 - 6 - 8 - 10 mm.

Regulating key l. 500 mm., used for paving completed with 4 - 6 - 8 - 10 mm spacers.

Llave de regulación de 500 mm. de largo, que se utiliza con el suelo terminado con juntas de 4 - 6 - 8 - 10 mm.

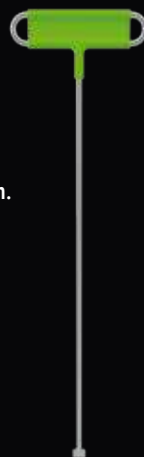

Art. 190

**PINZA POSAPIASTRE PER PIASTRE
 DI LATO 30 - 35 - 40 - 45 - 50 CM
 PAVING SLAB HANDLER 30 - 35 - 40 - 45 - 50 CM
 PINZA ESPESORADA PARA LOSAS DE 30 - 35 - 40 -
 45 - 50 CM DE LADO**



Art. 186.6 C

**CHIAVE DI REGOLAZIONE ITALPROFILI 25 CM
 ITALPROFILI REGULATING KEY 25 CM
 LLAVE DE REGULACIÓN ITALPROFILI 25 CM**

Chiave di regolazione l. 250 mm., utilizzabile a pavimentazione ultimata con fughe 4 - 6 - 8 - 10 mm.

Regulating key l. 250 mm., used for paving completed with 4 - 6 - 8 - 10 mm spacers.

Llave de regulación de 250 mm. de largo, que se utiliza con el suelo terminado con juntas de 4 - 6 - 8 - 10 mm.



Art. 195

**VENTOSA ALZAPIASTRELLE 110KG
 SUCTION CUP TILE LIFTER 110KG
 VENTOSA SUBIDA BALDOSAS 110 KG**



Art. 186.5

SPESSORE LIVELLANTE - LEVELING SPACER - ESPESOR NIVELANTE

Lo spessore livellante da 1,5 a 5 mm. può essere usato interamente, è impilabile o sezionabile per 1/2 o 1/4. Viene impiegato nei casi in cui la superficie di appoggio sia molto irregolare o per colmare i dislivelli creati dai sormonti del manto impermeabile. Può essere utilizzato anche per aumentare l'altezza finale del basamento di 5 mm.

The leveling spacer, from 1,5 to 5 mm, can be used as a whole, and can also be stacked or sectioned by 1/2 or 1/4. These components are used when the support surface is extremely irregular or to compensate for the differences in level created by overlaps in the waterproofing layer. It can also be used to increase the final height with 5 mm.

El espesor nivelante de 1,5 a 5 mm se puede utilizar por completo, apilar o cortar por 1/2 o 1/4. Se utiliza cuando la superficie de apoyo es muy irregular o para colmar los desniveles creados por el solapado de la membrana impermeable. También se puede utilizar para aumentar 5 mm la altura final del soporte.



ART. 185DP2 - 185DP4

DISTANZIALE PERIMTRALE INOX FUGA 2/4 mm - PERIMETRAL SPACER STAINLESS STEEL FOR HEAD SPACER 2/4 mm - DILATADOR PERIMETRAL ACERO INOX JUNTA 2/4 mm

Il distanziale perimetrale viene posato direttamente sopra la testa permettendo di tenere distanziata di 5 mm. la pavimentazione dal perimetro verticale di contenimento. Opportunamente sagomato per evitare lo sfregamento della pavimentazione sul perimetro verticale di contenimento ed assorbire eventuali movimenti e dilatazioni della pavimentazione. Realizzato in acciaio inox, spessore di 0,8 mm.

The perimetral spacer is laid directly on the head allowing to keep the flooring of a distance of 5 mm from the vertical containment perimeter. Suitably shaped to avoid the rubbing of the pavement on the vertical containment perimeter and to absorb any movement and expansion of the pavement. Made of stainless steel, 0,8 mm thick.

El dilatador perimetral se coloca directamente sobre la cabeza, permitiendo mantener el pavimento a 5 mm de distancia del perímetro vertical de contención. Tiene una forma adecuada para evitar que el pavimento frote sobre el perímetro vertical de contención y para absorber posibles movimientos y dilataciones del pavimento. Está hecho de acero inoxidable de 0,8 mm de espesor.



Art. 185CV2 - 185CV4

**SET CLIP CHIUSURA VERTICALI FUGA 2/4 mm
SET CLIP FOR VERTICAL CLOSURE SPACER 2/4 mm
JUEGO DE CERRAMIENTOS VERTICALES JUNTA 2/4 mm**

I set clip chiusura verticali Italprofili sono studiati per dare un aggancio robusto ed esteticamente gradevole alle chiusure dei bordi perimetrali verticali nelle pavimentazioni sopraelevate, creando così un contenimento perimetrale per la pavimentazione. Realizzate in acciaio inox spessore 0,8 mm. sono disponibili con fuga 2 o 4 mm.

The Italprofili set clip for vertical closure is designed to give a strong and aesthetically pleasing attachment to the closing of the vertical perimeter edges in raised floors, thus creating a perimeter containment for the flooring. Made of 0,8 mm thick stainless steel, they are available with 2 or 4 mm spacers.

Los juegos de cerramientos verticales Italprofili están diseñados para un enganche fuerte y estéticamente agradable en los remates de los bordes perimetrales verticales en los suelos elevados, creando así una contención perimetral para el pavimento. Hechos de acero inoxidable de 0,8 mm de espesor, están disponibles con juntas de 2 o 4 mm.



VOCE DI CAPITOLATO DEL SISTEMA SPECIAL FH DUAL SYSTEM EVOLUTION DESCRIPTION FOR SPECIFICATIONS OF THE SPECIAL FH DUAL SYSTEM EVOLUTION ESPECIFICACIONES TÉCNICAS DEL SISTEMA SPECIAL FH DUAL SYSTEM EVOLUTION

SPECIAL FH DUAL SYSTEM EVOLUTION

Fornitura e posa in opera di basamenti regolabili del tipo Italprofili linea Special FH, modello Dual System Evolution in polipropilene, per la realizzazione di pavimentazioni sopraelevate per esterno, con finitura ceramica, decking o legno.

Il sistema è composto da:

- Basamento Special FH Dual System Evolution (base e vite filettate).
- Testa Special Fissa Dual System Evolution con aggancio rapido per travetto.
- Travetto in alluminio Dual System Evolution disponibile in due versioni: mm. 62x15 l. 2000 o mm. 62x25 l. 2000.
- Profilo silenziatore in gomma Dual System Evolution ad innesto rapido (solo per finitura ceramica).
- Elemento fuga Dual System Evolution da 2 o 4 mm (solo per finitura ceramica).

SPECIAL FH DUAL SYSTEM EVOLUTION

Supply and installation of adjustable Special FH paving supports Dual System Evolution made of polypropylene, for the realisation of raised floors for exteriors with ceramic, decking or wood.

The system consists of:

- Special FH paving support Dual System Evolution (threaded base and screw).
- Fixed head Special Dual System Evolution with quick coupling for the joist.
- Aluminium joist Dual System Evolution available in two variations: mm. 62x15 l. 2000 or mm. 62x25 l. 2000.
- Non-slip silencer profile Dual System Evolution made of rubber with quick coupling (only for ceramic flooring).
- Spacer element Dual System Evolution 2 or 4 mm. (only for ceramic flooring).

SPECIAL FH DUAL SYSTEM EVOLUTION

Suministro y puesta en obra de soportes regulables de tipo Italprofili línea Special FH, modelo Dual System Evolution de polipropileno, para la realización de suelos elevados para exterior, con acabado cerámico, de tarima o madera.

El sistema se compone de:

- Soporte Special FH Dual System Evolution (base y tornillo roscado).
- Cabeza Special Fija Dual System Evolution con enganche rápido para viga.
- Viga de aluminio Dual System Evolution disponible en dos versiones: mm. 62x15 l. 2000 o mm. 62x25 l. 2000.
- Perfil de almohadilla de goma Dual System Evolution de acople rápido (solo para acabado cerámico).
- Elemento junta Dual System Evolution de 2 o 4 mm (solo para acabado cerámico).

SISTEMI PER PAVIMENTAZIONI SOPRAELEVATE DA ESTERNO
SYSTEMS FOR RAISED FLOORS FOR EXTERIORS
SISTEMAS PARA SUELOS ELEVADOS PARA EXTERIORES

SPECIAL LIGHT DUAL SYSTEM EVOLUTION CON TESTA FISSA

SPECIAL LIGHT DUAL SYSTEM EVOLUTION WITH FIXED HEAD

SPECIAL LIGHT DUAL SYSTEM EVOLUTION CON CABEZA FIJA

**BASAMENTO REGOLABILE
ADJUSTABLE PAVING SUPPORT
SOPORTE REGULABLE**

Art. 187DSE	22 ÷ 35 mm
Art. 187.1DSE	35 ÷ 55 mm
Art. 187.2DSE	55 ÷ 95 mm
Art. 187.3DSE	95 ÷ 165 mm
Art. 187.4DSE	165 ÷ 235 mm
Art. 187.5DSE	200 ÷ 270 mm
Art. 187.6DSE	260 ÷ 340 mm
Art. 187.7DSE	305 ÷ 375 mm
Art. 187.8DSE	365 ÷ 445 mm
Art. 187.9DSE	410 ÷ 480 mm
Art. 187.10DSE	470 ÷ 550 mm

TESTA SPECIAL LIGHT FISSA DUAL SYSTEM EVOLUTION
FIXED HEAD SPECIAL LIGHT DUAL SYSTEM EVOLUTION
CABEZA SPECIAL LIGHT FIJA DUAL SYSTEM EVOLUTION



Art. 188DSE

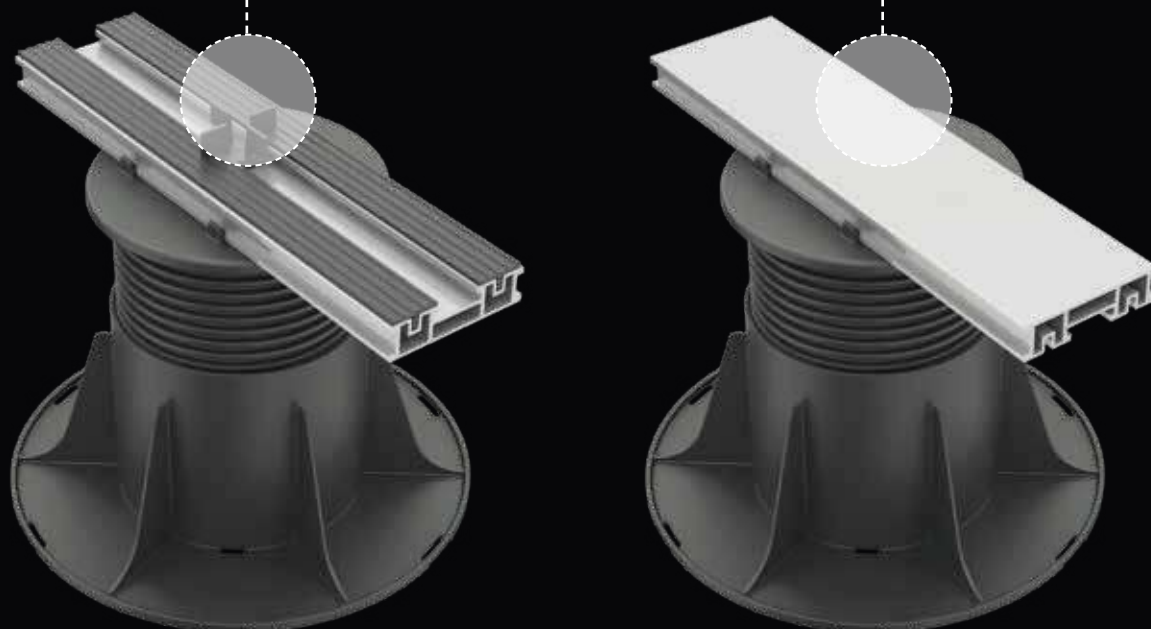

TESTA SPECIAL LIGHT FISSA DUAL SYSTEM EVOLUTION FIXED HEAD SPECIAL LIGHT DUAL SYSTEM EVOLUTION CABEZA SPECIAL LIGHT FIJA DUAL SYSTEM EVOLUTION

Testa Special Light fissa Dual System Evolution, dotata di 4 agganci per l'installazione rapida del travetto in alluminio Dual System Evolution.

Fixed head Special Light Dual System Evolution, equipped with 4 couplings for quick installation of the Dual System Evolution aluminum joist.

Cabeza Special Light fija Dual System Evolution, dotata de 4 enganches para la instalación rápida de la viga de aluminio Dual System Evolution.

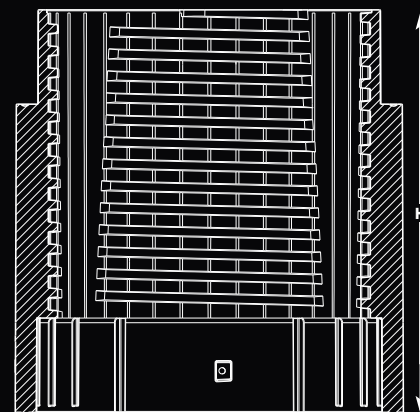
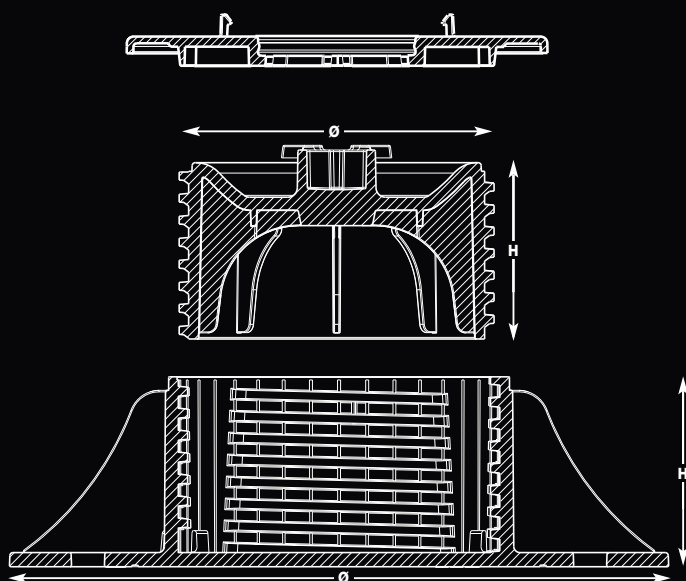
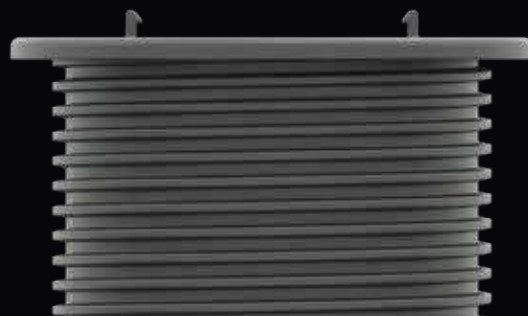

COMPOSIZIONE BASAMENTI REGOLABILI SPECIAL LIGHT DUAL SYSTEM EVOLUTION / COMPOSITION OF ADJUSTABLE SUPPORTS SPECIAL LIGHT DUAL SYSTEM EVOLUTION / COMPOSICIÓN SOPORTES REGULABLES SPECIAL LIGHT DUAL SYSTEM EVOLUTION

ARTICOLO CODE ART ARTÍCULO	MISURE SIZE MEDIDAS		BASE BASE BASE		VITE FILETTATA THREADED SCREW TORNILLO ROSCADO		PROLUNGA A MANICOTTO THREADED EXTENSION EXTENSIÓN CON MANGUITO		TESTA FISSA FIXED HEAD CABEZA FIJA	
	da mm. from mm. de mm.	a mm. to mm. a mm.	Ø mm.	h. mm.	Ø mm.	h. mm.	pezzi n. pieces n. cant. piezas	h. mm.	Ø mm.	h. mm.
187	22	35	200	20	100	17		126	120	6
187.1	35	55	200	33	100	30		126	120	6
187.2	55	95	200	53	100	50		126	120	6
187.3	95	165	200	93	100	90		126	120	6
187.4	165	235	200	93	100	160		126	120	6
187.5	200	270	200	93	100	90	1	126	120	6
187.6	260	340	200	93	100	160	1	126	120	6
187.7	305	375	200	93	100	90	2	126	120	6
187.8	365	445	200	93	100	160	2	126	120	6
187.9	410	480	200	93	100	90	3	126	120	6
187.10	470	550	200	93	100	160	3	126	120	6

Per garantire la portata e la perfetta efficienza del sistema di regolazione, si raccomanda di non oltrepassare la misura massima dichiarata nella descrizione del prodotto.

In order to guarantee the perfect efficiency of the regulation system, it is highly recommended not to exceed the maximum height indicated in the product description.

Para garantizar la capacidad de carga y la perfecta eficiencia del sistema de regulación, se recomienda no superar la medida máxima indicada en la descripción del producto.

TRAVETTO DUAL SYSTEM EVOLUTION

DUAL SYSTEM EVOLUTION JOIST

VIGA DUAL SYSTEM EVOLUTION

Il travetto Dual System Evolution può essere utilizzato come prodotto unico per la posa di pavimentazioni ceramiche e decking.

Prodotto in alluminio estruso, garantisce la massima durata nel tempo, un peso ridotto ed un'alta resistenza.

Disponibile in due versioni:

- 15 mm: lo spessore più basso disponibile nel mercato.
- 25 mm: per una portata ancora più elevata.

The Dual System Evolution joist can be used as a single product for laying ceramic and decking flooring. Produced in extruded aluminum, it guarantees maximum durability, reduced weight and high resistance.

It is available in two variations:

- 15 mm: the lowest thickness available on the market.
- 25 mm: for an even higher load capacity.

La viga Dual System Evolution puede utilizarse como producto único para la puesta de pavimentos cerámicos y de tarima.

Fabricada en aluminio extruido, garantiza la máxima duración a lo largo del tiempo, un peso reducido y una elevada resistencia.

Disponibile en dos versiones:

- 15 mm: el espesor más bajo disponible en el mercado.
- 25 mm: para una carga aún más elevada.

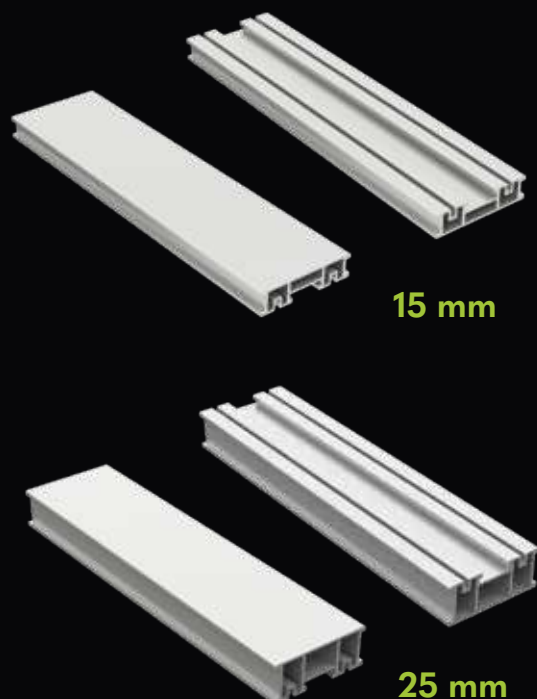

15 mm

25 mm

SISTEMA GIUNZIONE TRAVETTO JOIST JOINT SYSTEM SISTEMA UNIÓN VIGA

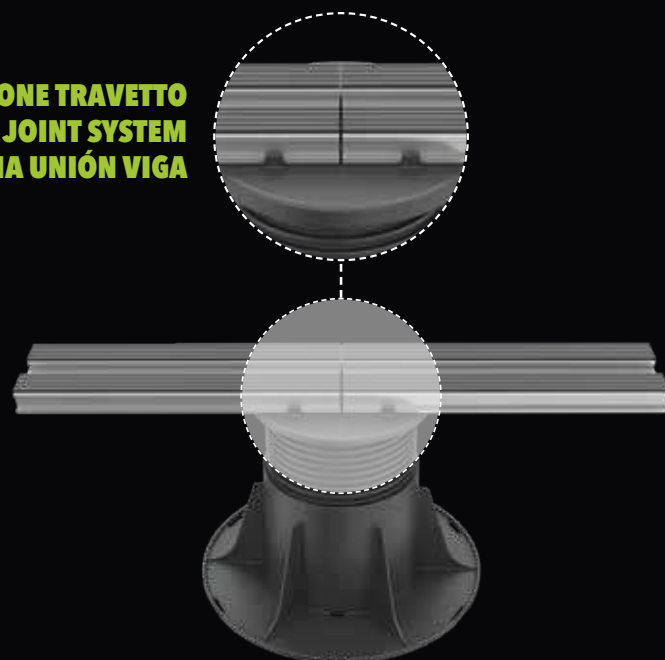

Art. 6215DSE



Art. 6225DSE

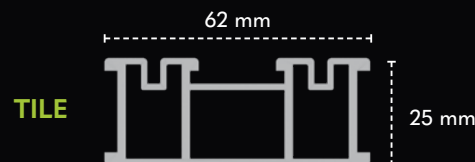

ARTICOLI OPZIONALI PER TRAVETTO DUAL SYSTEM EVOLUTION

OPTIONAL ITEMS FOR DUAL SYSTEM EVOLUTION JOIST

ARTÍCULOS OPCIONALES PARA VIGA DUAL SYSTEM EVOLUTION

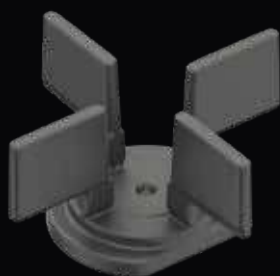
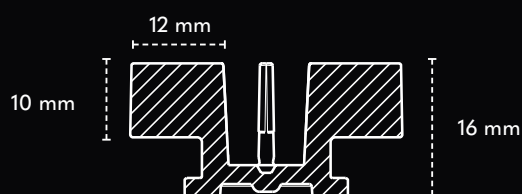

Art. XDSE.02

ELEMENTO FUGA DUAL SYSTEM EVOLUTION 2 MM. - SPACER ELEMENT DUAL SYSTEM EVOLUTION 2 MM. - ELEMENTO JUNTA DUAL SYSTEM EVOLUTION 2 MM.

Art. XDSE.04

ELEMENTO FUGA DUAL SYSTEM EVOLUTION 4 MM. - SPACER ELEMENT DUAL SYSTEM EVOLUTION 4 MM. - ELEMENTO JUNTA DUAL SYSTEM EVOLUTION 4 MM.

Elemento fuga, disponibile da 2 o 4 mm, studiato appositamente per distanziare gli elementi della pavimentazione; garantisce un appoggio totale della pavimentazione sul travetto.

Spacer element, available in 2 or 4 mm, specially designed to space out the elements of the flooring; guarantees total support of the paving on the joist.

Elemento junta, disponibile in 2 o 4 mm, estudiado especialmente para separar los elementos del pavimento; garantiza un apoyo total del pavimento en la viga.

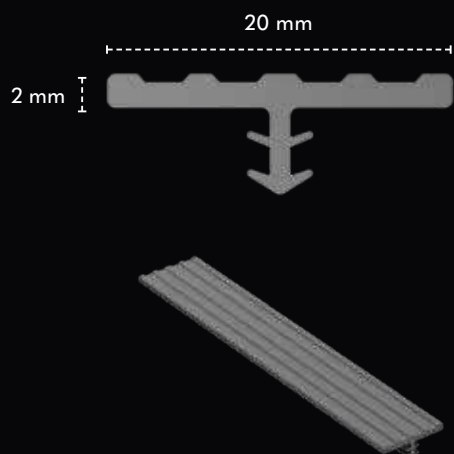

Art. SIL.DSE

PROFILO SILENZIATORE ANTISDRUCCIOLO PER TRAVETTO DUAL SYSTEM EVOLUTION - NON-SLIP SILENCER PROFILE FOR DUAL SYSTEM EVOLUTION JOIST - PERFIL DE ALMOHADILLA ANTIDESLIZANTE PARA VIGA DUAL SYSTEM EVOLUTION

Il profilo silenziatore per il travetto Dual System Evolution è prodotto in gomma fonoassorbente. Viene inserito nelle apposite guide del travetto abbattendo così il rumore derivante dal calpestio e creando un effetto antisdrucciolo.

The silencer profile for the Dual System Evolution joist is made of sound-absorbing rubber. It is inserted into the special guides of the joist thus reducing the noise deriving from trampling and creating a non-slip effect.

El perfil de almohadilla para la viga Dual System Evolucion está fabricado con goma fonoabsorbente. Se introduce en las relativas guías de la viga eliminando el ruido derivado de las pisadas y creando un efecto antideslizante.

ARTICOLI OPZIONALI PER **SISTEMA SPECIAL LIGHT** **DUAL SYSTEM EVOLUTION**

OPTIONAL ITEMS FOR SPECIAL LIGHT DUAL SYSTEM EVOLUTION

ARTÍCULOS OPCIONALES PARA SISTEMA SPECIAL LIGHT DUAL SYSTEM EVOLUTION

Art. 188.4

PROLUNGA FILETTATA
SLEEVE EXTENSION
EXTENSIÓN ROSCADA

La prolunga filettata viene utilizzata per basamenti regolabili dai 235 mm ai 550 mm.

The sleeve extension is used for adjustable support systems from 235 mm to 550 mm.

La extensión roscada se utiliza para los soportes regulables de 235 mm a 550 mm.



Art. 186.6

CHIAVE DI REGOLAZIONE ITALPROFILI 50 CM
ITALPROFILI REGULATING KEY 50 CM
LLAVE DE REGULACIÓN ITALPROFILI 50 CM

Chiave di regolazione l. 500 mm., utilizzabile a pavimentazione ultimata con fughe 4 - 6 - 8 - 10 mm.

Regulating key l. 500 mm., used for paving completed with 4 - 6 - 8 - 10 mm spacers.

Llave de regulación de 500 mm. de largo, que se utiliza con el suelo terminado con juntas de 4 - 6 - 8 - 10 mm.

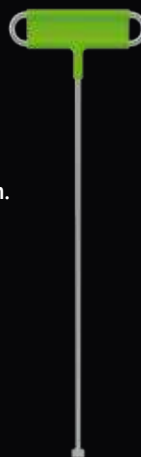

Art. 190

PINZA POSAPIASTRE PER PIASTRE
DI LATO 30 - 35 - 40 - 45 - 50 CM
PAVING SLAB HANDLER 30 - 35 - 40 - 45 - 50 CM
PINZA ESPESORADA PARA LOSAS DE 30 - 35 - 40 - 45 - 50 CM DE LADO



Art. 186.6 C

CHIAVE DI REGOLAZIONE ITALPROFILI 25 CM
ITALPROFILI REGULATING KEY 25 CM
LLAVE DE REGULACIÓN ITALPROFILI 25 CM

Chiave di regolazione l. 250 mm., utilizzabile a pavimentazione ultimata con fughe 4 - 6 - 8 - 10 mm.

Regulating key l. 250 mm., used for paving completed with 4 - 6 - 8 - 10 mm spacers.

Llave de regulación de 250 mm. de largo, que se utiliza con el suelo terminado con juntas de 4 - 6 - 8 - 10 mm.



Art. 195

VENTOSA ALZAPIASTRELLE 110KG
SUCTION CUP TILE LIFTER 110KG
VENTOSA SUBIDA BALDOSAS 110 KG



Art. 186.5

SPESSORE LIVELLANTE - LEVELING SPACER - ESPESOR NIVELANTE

Lo spessore livellante da 1,5 a 5 mm. può essere usato interamente, è impilabile o sezionabile per 1/2 o 1/4. Viene impiegato nei casi in cui la superficie di appoggio sia molto irregolare o per colmare i dislivelli creati dai sormonti del manto impermeabile. Può essere utilizzato anche per aumentare l'altezza finale del basamento di 5 mm.

The leveling spacer, from 1,5 to 5 mm, can be used as a whole, and can also be stacked or sectioned by 1/2 or 1/4. These components are used when the support surface is extremely irregular or to compensate for the differences in level created by overlaps in the waterproofing layer. It can also be used to increase the final height with 5 mm.

El espesor nivelante de 1,5 a 5 mm se puede utilizar por completo, apilar o cortar por 1/2 o 1/4. Se utiliza cuando la superficie de apoyo es muy irregular o para colmar los desniveles creados por el solapado de la membrana impermeable. También se puede utilizar para aumentar 5 mm la altura final del soporte.



ART. 185DP2 - 185DP4

DISTANZIALE PERIMTRALE INOX FUGA 2/4 mm - PERIMETRAL SPACER STAINLESS STEEL FOR HEAD SPACER 2/4 mm - DILATADOR PERIMETRAL ACERO INOX JUNTA 2/4 mm

Il distanziale perimetrale viene posato direttamente sopra la testa permettendo di tenere distanziata di 5 mm. la pavimentazione dal perimetro verticale di contenimento. Opportunamente sagomato per evitare lo sfregamento della pavimentazione sul perimetro verticale di contenimento ed assorbire eventuali movimenti e dilatazioni della pavimentazione. Realizzato in acciaio inox, spessore di 0,8 mm.

The perimetral spacer is laid directly on the head allowing to keep the flooring of a distance of 5 mm from the vertical containment perimeter. Suitably shaped to avoid the rubbing of the pavement on the vertical containment perimeter and to absorb any movement and expansion of the pavement. Made of stainless steel, 0,8 mm thick.

El dilatador perimetral se coloca directamente sobre la cabeza, permitiendo mantener el pavimento a 5 mm de distancia del perímetro vertical de contención. Tiene una forma adecuada para evitar que el pavimento frote sobre el perímetro vertical de contención y para absorber posibles movimientos y dilataciones del pavimento. Está hecho de acero inoxidable de 0,8 mm de espesor.



ART. 187CL1 - 187CL1.67 - 187CL2

CUNEO LIVELLANTE - LEVELLER SHIMS - CUÑA NIVELADORA

Il cuneo livellante, disponibile nelle versioni 1%, 1,67% e 2%, viene impiegato nei sottofondi dove vi è la presenza di pendenza. Ideale per essere utilizzato con la linea Special Light, viene appoggiato direttamente sul piano di posa per poi poterci posare il basamento, creando così una superficie finita perfettamente piana.

The leveller shims, available in the 1%, 1,67% and 2% versions, are used in bases where there is a slope. Ideal to be used with our Special Light range, are placed directly on the laying surface to then be able to lay the support, thus creating a perfectly flat finished surface.

La cuña niveladora, disponible en las versiones de 1%, 1,67% y 2%, se utiliza en los sustratos donde está la pendiente. Ideal para ser utilizada con la línea Special Light, se apoya directamente sobre la superficie de colocación para luego montar el soporte, creando así una superficie terminada perfectamente en plano.



ART. 185CV2 - 185CV4

**SET CLIP CHIUSURA VERTICALI FUGA 2/4 mm
SET CLIP FOR VERTICAL CLOSURE SPACER 2/4 mm
JUEGO DE CERRAMIENTOS VERTICALES JUNTA 2/4 mm**

I set clip chiusura verticali Italprofili sono studiati per dare un aggancio robusto ed esteticamente gradevole alle chiusure dei bordi perimetrali verticali nelle pavimentazioni sopraelevate, creando così un contenimento perimetrale per la pavimentazione. Realizzate in acciaio inox spessore 0,8 mm. sono disponibili con fuga 2 o 4 mm.

The Italprofili set clip for vertical closure is designed to give a strong and aesthetically pleasing attachment to the closing of the vertical perimeter edges in raised floors, thus creating a perimeter containment for the flooring. Made of 0,8 mm thick stainless steel, they are available with 2 or 4 mm spacers.

Los juegos de cerramientos verticales Italprofili están diseñados para un enganche fuerte y estéticamente agradable en los remates de los bordes perimetrales verticales en los suelos elevados, creando así una contención perimetral para el pavimento. Hechos de acero inoxidable de 0,8 mm de espesor, están disponibles con juntas de 2 o 4 mm.

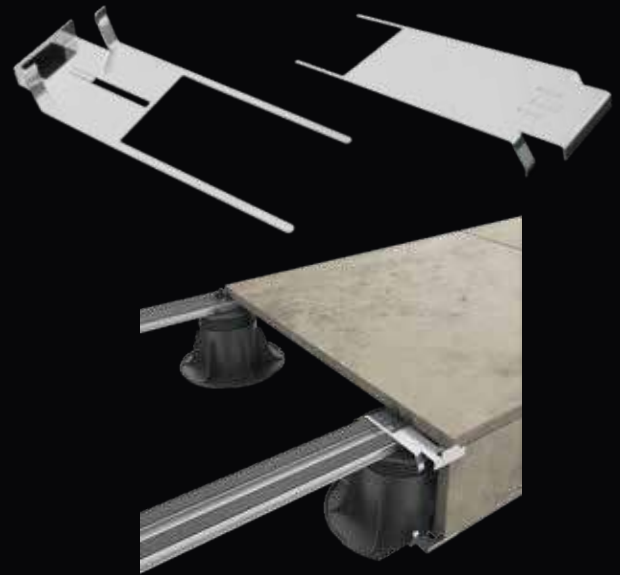

VOCE DI CAPITOLATO DEL SISTEMA SPECIAL LIGHT DUAL SYSTEM EVOLUTION DESCRIPTION FOR SPECIFICATIONS OF THE SPECIAL LIGHT DUAL SYSTEM EVOLUTION ESPECIFICACIONES TÉCNICAS DEL SISTEMA SPECIAL LIGHT DUAL SYSTEM EVOLUTION

SPECIAL LIGHT DUAL SYSTEM EVOLUTION

Fornitura e posa in opera di basamenti regolabili del tipo Italprofili linea Special Light, modello Dual System Evolution in polipropilene, per la realizzazione di pavimentazioni sopraelevate per esterno, con finitura ceramica, decking o legno.

Il sistema è composto da:

- Basamento Special Light Dual System Evolution (base e vite filettate).
- Testa fissa Special Light Dual System Evolution con aggancio rapido per travetto.
- Travetto in alluminio Dual System Evolution disponibile in due versioni: mm. 62x15 l. 2000 o mm. 62x25 l. 2000.
- Profilo silenziatore in gomma Dual System Evolution ad innesto rapido (solo per finitura ceramica).
- Elemento fuga Dual System Evolution da 2 o 4 mm (solo per finitura ceramica).

SPECIAL LIGHT DUAL SYSTEM EVOLUTION

Supply and installation of adjustable Special Light paving supports Dual System Evolution made of polypropylene, for the realisation of raised floors for exteriors with ceramic, decking or wood.

The system consists of:

- Special Light paving support Dual System Evolution (threaded base and screw).
- Fixed head Special Light Dual System Evolution with quick coupling for the joist.
- Aluminium joist Dual System Evolution available in two variations: mm. 62x15 l. 2000 or mm. 62x25 l. 2000.
- Non-slip silencer profile Dual System Evolution made of rubber with quick coupling (only for ceramic flooring).
- Spacer element Dual System Evolution 2 or 4 mm. (only for ceramic flooring).

SPECIAL LIGHT DUAL SYSTEM EVOLUTION

Suministro y puesta en obra de soportes regulables de tipo Italprofili línea Special Light, modelo Dual System Evolution de polipropileno, para la realización de suelos elevados para exterior, con acabado cerámico, de tarima o madera.

El sistema se compone de:

- Soporte Special Light Dual System Evolution (base y tornillos roscados).
- Cabeza fija Special Light Dual System Evolution con enganche rápido para viga.
- Viga de aluminio Dual System Evolution disponible en dos versiones: mm. 62x15 l. 2000 o mm. 62x25 l. 2000.
- Perfil de almohadilla de goma Dual System Evolution de acople rápido (solo para acabado cerámico).
- Elemento junta Dual System Evolution de 2 o 4 mm (solo para acabado cerámico).

SISTEMI PER PAVIMENTAZIONI SOPRAELEVATE DA ESTERNO
SYSTEMS FOR RAISED FLOORS FOR EXTERIORS
SISTEMAS PARA SUELOS ELEVADOS PARA EXTERIORES

RAISE-UP DUAL SYSTEM EVOLUTION CON TESTA FISSA

RAISE-UP DUAL SYSTEM EVOLUTION WITH FIXED HEAD

RAISE-UP DUAL SYSTEM EVOLUTION CON CABEZA FIJA

BASAMENTO REGOLABILE
ADJUSTABLE PAVING SUPPORT
SOPORTE REGULABLE

Art. 183DSE 10 ÷ 16 mm
Art. 183.1DSE 16 ÷ 22 mm

Art. 183DSE
10 ÷ 16 mm

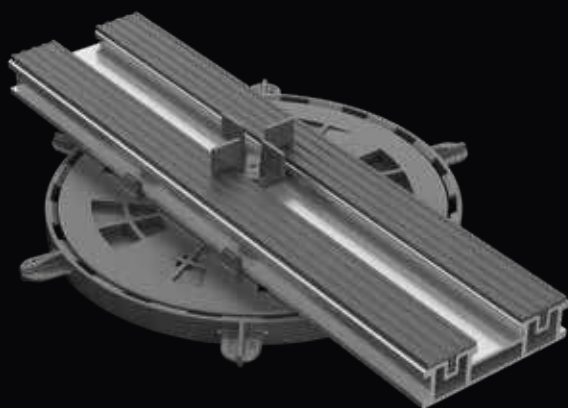

TILE



DECKING

Art. 183.1DSE
16 ÷ 22 mm

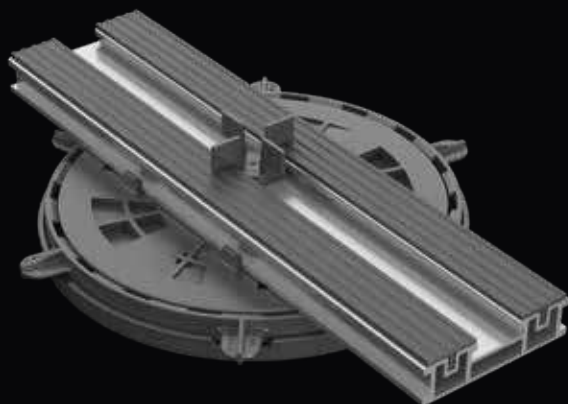

TILE



DECKING



RAISE-UP DUAL SYSTEM EVOLUTION CON TESTA FISSA

RAISE-UP DUAL SYSTEM EVOLUTION WITH FIXED HEAD

RAISE-UP DUAL SYSTEM EVOLUTION CON CABEZA FIJA

Art. 183DSE

Art. 183.1DSE



COMPOSIZIONE BASAMENTI REGOLABILI RAISE-UP DUAL SYSTEM EVOLUTION / COMPOSITION OF ADJUSTABLE SUPPORTS RAISE-UP DUAL SYSTEM EVOLUTION / COMPOSICIÓN SOPORTES REGULABLES RAISE-UP DUAL SYSTEM EVOLUTION

ARTICOLO CODE ART ARTÍCULO	MISURE SIZE MEDIDAS		BASE BASE BASE		TESTA FISSA FIXED HEAD CABEZA FIJA		RIALZO RAISE-UP RAISE-UP LIFT ELEVACIÓN RAISE-UP	
	da mm. from mm. de mm.	a mm. to mm. a mm.	Ø mm.	h. mm.	Ø mm.	h. mm.	Ø mm.	h. mm.
183DSE	10	16	150	10	140	9		
183.1DSE	16	22	150	16	140	9	156	6

Per garantire la portata e la perfetta efficienza del sistema di regolazione, si raccomanda di non oltrepassare la misura massima dichiarata nella descrizione del prodotto.

In order to guarantee the perfect efficiency of the regulation system, it is highly recommended not to exceed the maximum height indicated in the product description.

Para garantizar la capacidad de carga y la perfecta eficiencia del sistema de regulación, se recomienda no superar la medida máxima indicada en la descripción del producto.

TRAVETTO DUAL SYSTEM EVOLUTION

DUAL SYSTEM EVOLUTION JOIST

VIGA DUAL SYSTEM EVOLUTION

Il travetto Dual System Evolution può essere utilizzato come prodotto unico per la posa di pavimentazioni ceramiche e decking.

Prodotto in alluminio estruso, garantisce la massima durata nel tempo, un peso ridotto ed un'alta resistenza.

Disponibile in due versioni:

- 15 mm: lo spessore più basso disponibile nel mercato.
- 25 mm: per una portata ancora più elevata.

The Dual System Evolution joist can be used as a single product for laying ceramic and decking flooring. Produced in extruded aluminum, it guarantees maximum durability, reduced weight and high resistance.

It is available in two variations:

- 15 mm: the lowest thickness available on the market.
- 25 mm: for an even higher load capacity.

La viga Dual System Evolution puede utilizarse como producto único para la puesta de pavimentos cerámicos y de tarima.

Fabricada en aluminio extruido, garantiza la máxima duración a lo largo del tiempo, un peso reducido y una elevada resistencia.

Disponibile en dos versiones:

- 15 mm: el espesor más bajo disponible en el mercado.
- 25 mm: para una carga aún más elevada.

Art. 6215DSE

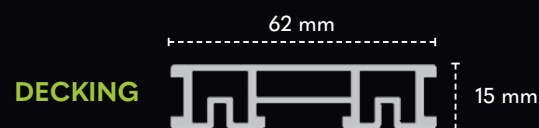

Art. 6225DSE

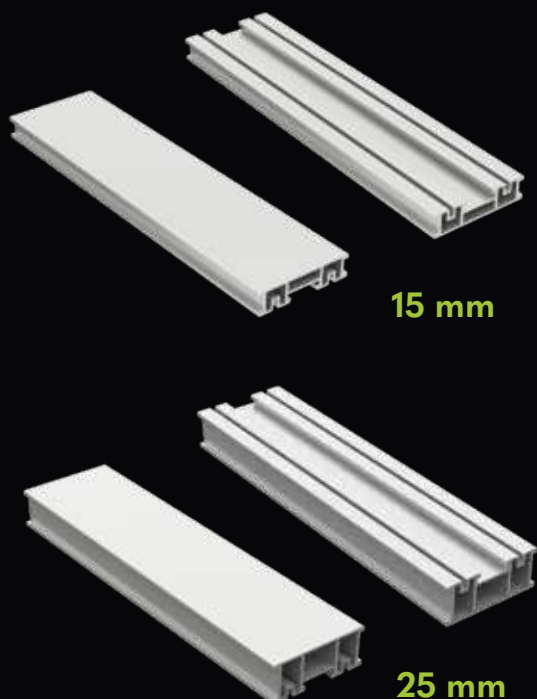
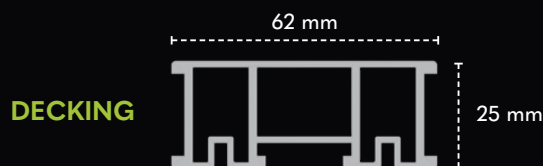
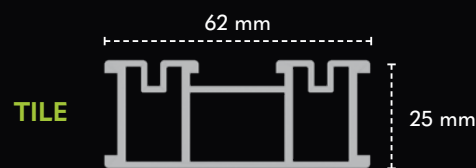

SISTEMA GIUNZIONE TRAVETTO JOIST JOINT SYSTEM SISTEMA UNIÓN VIGA

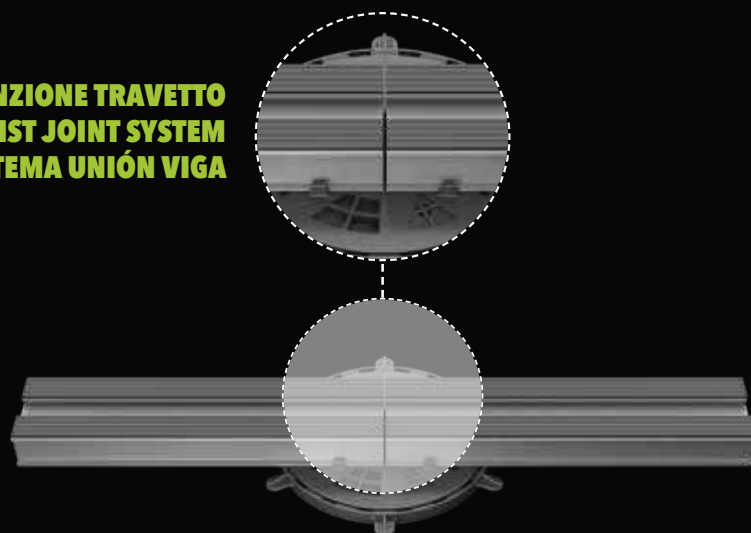

ARTICOLI OPZIONALI PER TRAVETTO DUAL SYSTEM EVOLUTION

OPTIONAL ITEMS FOR DUAL SYSTEM EVOLUTION JOIST

ARTÍCULOS OPCIONALES PARA VIGA DUAL SYSTEM EVOLUTION

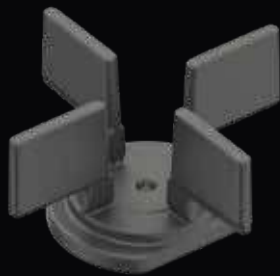
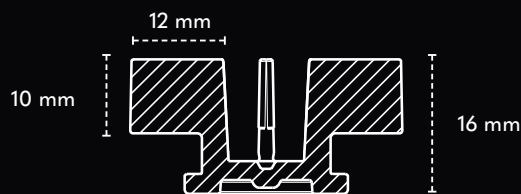

Art. XDSE.02

ELEMENTO FUGA DUAL SYSTEM EVOLUTION 2 MM. - SPACER ELEMENT DUAL SYSTEM EVOLUTION 2 MM. - ELEMENTO JUNTA DUAL SYSTEM EVOLUTION 2 MM.

Art. XDSE.04

ELEMENTO FUGA DUAL SYSTEM EVOLUTION 4 MM. - SPACER ELEMENT DUAL SYSTEM EVOLUTION 4 MM. - ELEMENTO JUNTA DUAL SYSTEM EVOLUTION 4 MM.

Elemento fuga, disponibile da 2 o 4 mm, studiato appositamente per distanziare gli elementi della pavimentazione; garantisce un appoggio totale della pavimentazione sul travetto.

Spacer element, available in 2 or 4 mm, specially designed to space out the elements of the flooring; guarantees total support of the paving on the joist.

Elemento junta, disponibile in 2 o 4 mm, estudiado especialmente para separar los elementos del pavimento; garantiza un apoyo total del pavimento en la viga.

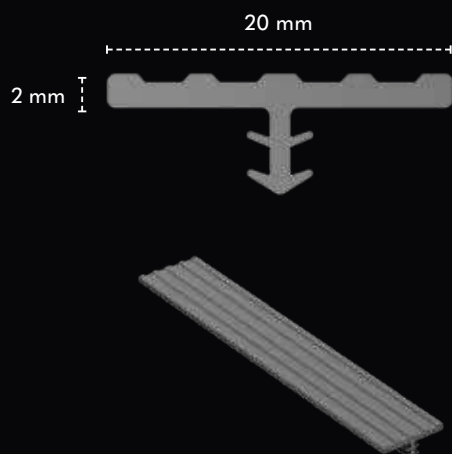

Art. SIL.DSE

PROFILO SILENZIATORE ANTISDRUCCIOLO PER TRAVETTO DUAL SYSTEM EVOLUTION - NON-SLIP SILENCER PROFILE FOR DUAL SYSTEM EVOLUTION JOIST - PERFIL DE ALMOHADILLA ANTIDESLIZANTE PARA VIGA DUAL SYSTEM EVOLUTION

Il profilo silenziatore per il travetto Dual System Evolution è prodotto in gomma fonoassorbente. Viene inserito nelle apposite guide del travetto abbattendo così il rumore derivante dal calpestio e creando un effetto antisdrucciolo.

The silencer profile for the Dual System Evolution joist is made of sound-absorbing rubber. It is inserted into the special guides of the joist thus reducing the noise deriving from trampling and creating a non-slip effect.

El perfil de almohadilla para la viga Dual System Evolucion está fabricado con goma fonoabsorbente. Se introduce en las relativas guías de la viga eliminando el ruido derivado de las pisadas y creando un efecto antideslizante.

ARTICOLI OPZIONALI PER **SISTEMA RAISE-UP** **DUAL SYSTEM EVOLUTION**

OPTIONAL ITEMS FOR RAISE-UP DUAL SYSTEM EVOLUTION

ARTÍCULOS OPCIONALES PARA SISTEMA RAISE-UP DUAL SYSTEM EVOLUTION

Art. 186.5

SPESSORE LIVELLANTE - LEVELING SPACER - ESPESOR NIVELANTE

Lo spessore livellante da 1,5 a 5 mm. può essere usato interamente, è impilabile o sezionabile per $\frac{1}{2}$ o $\frac{1}{4}$. Viene impiegato nei casi in cui la superficie di appoggio sia molto irregolare o per colmare i dislivelli creati dai sormonti del manto impermeabile. Può essere utilizzato anche per aumentare l'altezza finale del basamento di 5 mm.

The leveling spacer, from 1,5 to 5 mm, can be used as a whole, and can also be stacked or sectioned by $\frac{1}{2}$ or $\frac{1}{4}$. These components are used when the support surface is extremely irregular or to compensate for the differences in level created by overlaps in the waterproofing layer. It can also be used to increase the final height with 5 mm.

El espesor nivelante de 1,5 a 5 mm se puede utilizar por completo, apilar o cortar por $\frac{1}{2}$ o $\frac{1}{4}$. Se utiliza cuando la superficie de apoyo es muy irregular o para colmar los desniveles creados por el solapado de la membrana impermeable. También se puede utilizar para aumentar 5 mm la altura final del soporte.



Art. 190

PINZA POSAPIASTRE PER PIASTRE DI LATO 30 - 35 - 40 - 45 - 50 CM
PAVING SLAB HANDLER 30 - 35 - 40 - 45 - 50 CM
PINZA ESPESORADA PARA LOSAS DE 30 - 35 - 40 - 45 - 50 CM DE LADO



Art. 195

VENTOSA ALZAPIASTRELLE 110KG
SUCTION CUP TILE LIFTER 110KG
VENTOSA SUBIDA BALDOSAS 110 KG



ART. 185DP2 - 185DP4

DISTANZIALE PERIMETRALE INOX FUGA 2/4 mm - PERIMETRAL SPACER STAINLESS STEEL FOR HEAD SPACER 2/4 mm - DILATADOR PERIMETRAL ACERO INOX JUNTA 2/4 mm

Il distanziale perimetrale viene posato direttamente sopra la testa permettendo di tenere distanziata di 5 mm la pavimentazione dal perimetro verticale di contenimento. Opportunamente sagomato per evitare lo sfregamento della pavimentazione sul perimetro verticale di contenimento ed assorbire eventuali movimenti e dilatazioni della pavimentazione. Realizzato in acciaio inox, spessore di 0,8 mm.

The perimetral spacer is laid directly on the head allowing to keep the flooring at a distance of 5 mm from the vertical containment perimeter. Suitably shaped to avoid the rubbing of the pavement on the vertical containment perimeter and to absorb any movement and expansion of the pavement. Made of stainless steel, 0,8 mm thick.

El dilatador perimetral se coloca directamente sobre la cabeza, permitiendo mantener el pavimento a 5 mm de distancia del perímetro vertical de contención. Tiene una forma adecuada para evitar que el pavimento frote sobre el perímetro vertical de contención y para absorber posibles movimientos y dilataciones del pavimento. Está hecho de acero inoxidable de 0,8 mm de espesor.



ART. 183.4

RIALZO RAISE-UP 6 MM. - RAISE-UP LIFT 6 MM. - ELEVACIÓN RAISE-UP 6 MM.

Il rialzo Raise-up è applicabile solo sull'Art. 183DSE e consente di modificare l'altezza del basamento di 6 mm, ottenendo la nuova misura 16-22 mm.

The Raise-up lift is applicable only on Art. 183DSE and allows to change the height of the base of 6 mm, obtaining the new measure 16-22 mm.

La elevación Raise-up se puede aplicar solo al Art. 183DSE y permite modificar 6 mm. la altura de la base obteniendo una nueva medida 16-22 mm.



VOCE DI CAPITOLATO DEL SISTEMA RAISE-UP DUAL SYSTEM EVOLUTION DESCRIPTION FOR SPECIFICATIONS OF THE RAISE-UP DUAL SYSTEM EVOLUTION ESPECIFICACIONES TÉCNICAS DEL SISTEMA RAISE-UP DUAL SYSTEM EVOLUTION

RAISE-UP DUAL SYSTEM EVOLUTION

Fornitura e posa in opera di basamenti regolabili del tipo Italprofili linea Raise-up, modello Dual System Evolution in polipropilene, per la realizzazione di pavimentazioni sopraelevate per esterno, con finitura ceramica, decking o legno.

Il sistema è composto da:

- Basamento Raise-up Dual System Evolution (base e testa con rampe inclinate).
- Travetto in alluminio Dual System Evolution, disponibile in due versioni: mm. 62x15 l. 2000 o mm. 62x25 l. 2000.
- Profilo silenziatore in gomma Dual System Evolution ad innesto rapido (solo per finitura ceramica).
- Elemento fuga Dual System Evolution da 2 o 4 mm (solo per finitura ceramica).

RAISE-UP DUAL SYSTEM EVOLUTION

Supply and installation of adjustable Raise-up paving supports Dual System Evolution made of polypropylene, for the realisation of raised floors for exteriors with ceramic, decking or wood.

The system consists of:

- Raise-up paving support Dual System Evolution (base and head with inclined ramps).
- Aluminium joist Dual System Evolution, available in two variations: mm. 62x15 l. 2000 or mm. 62x25 l. 2000.
- Non-slip silencer profile Dual System Evolution made of rubber with quick coupling (only for ceramic flooring).
- Spacer element Dual System Evolution 2 or 4 mm (only for ceramic flooring).

RAISE-UP DUAL SYSTEM EVOLUTION

Suministro y puesta en obra de soportes regulables de tipo Italprofili línea Raise-Up, modelo Dual System Evolution de polipropileno, para la realización de suelos elevados para exterior, con acabado cerámico, de tarima o madera.

El sistema se compone de:

- Soporte Raise-up Dual System Evolution (base y cabeza con rampas inclinadas).
- Viga de aluminio Dual System Evolution, disponible en dos versiones: mm. 62x15 l. 2000 o mm. 62x25 l. 2000.
- Perfil de almohadilla de goma Dual System Evolution de acople rápido (solo para acabado cerámico).
- Elemento junta Dual System Evolution de 2 o 4 mm (solo para acabado cerámico).



ITALPROFILI[®]
RESISTANT TO TIME



CONSUMI A MQ. DUAL SYSTEM EVOLUTION CON FINITURA PAVIMENTAZIONE CERAMICA

Le seguenti tabelle indicano il fabbisogno a mq dei componenti del sistema Dual System Evolution per pavimentazioni sopraelevate con finitura ceramica.

I conteggi sono stati sviluppati con posa del travetto Dual System Evolution sia con orientamento regolare che ortogonale rispetto alla pavimentazione di finitura, per porzioni di aree da pavimentare:

- Centrali
- Perimetrali
- Angolari

È stato considerato un interasse di appoggio dei basamenti di 60 cm. sul travetto, mentre l'interasse tra i travetti varia in base al formato della pavimentazione.

CONSUMPTIONS OF DUAL SYSTEM EVOLUTION PER SQM. WITH CERAMIC FLOORING

The following tables indicate the requirements per square meter of the components of the Dual System Evolution for raised floors with ceramic.

The calculations have been developed with the installation of the Dual System Evolution joist both in regular and orthogonal orientation with respect to the finishing flooring, for portions of areas to be paved:

- Central
- Perimetral
- Angular

It has been considered a center distance of the supports of 60 cm on the joist, while the distance between the joists varies according to the size of the flooring.

CONSUMOS POR M2 DUAL SYSTEM EVOLUTION CON ACABADO PAVIMENTO CERÁMICA

Las siguientes tablas indican las necesidades por m2 de los componentes del sistema Dual System Evolution para suelos elevados con acabados de tarima.

Los recuentos se han realizado con puesta de la viga Dual System Evolution tanto con orientación regular como ortogonal respecto al pavimento de acabado, para las partes de áreas que sola:

- Centrales
- Perimetrales
- Angulares

Se ha considerado una distancia entre ejes de apoyo de los soportes de 60 cm en la viga, mientras que la distancia entre ejes entre las vigas varía dependiendo del formato del pavimento.

FORMATO QUADRATO - SQUARE SHAPED - FORMATO CUADRADO

30 x 30 cm

CENTRALI - CENTRAL - CENTRALES
TRAVETTO REGOLARE - REGULAR JOIST - VIGA REGULAR

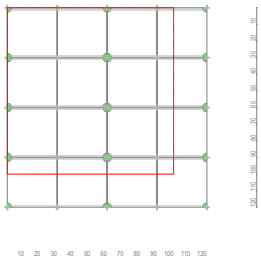

numero basamenti al m2	5,56
ml travetto al m2	3,33
ml profilo silenziatore al m2	6,66
numero elemento fuga al m2	11,11
number of supports per m2	5,56
lm joist per m2	3,33
lm silencer profile per m2	6,66
number of spacer element per m2	11,11
número soportes por m2	5,56
ml viga por m2	3,33
ml perfil de almohadilla por m2	6,66
número elemento junta por m2	11,11

CENTRALI - CENTRAL - CENTRALES
TRAVETTO ORTOGONALE - ORTHOGONAL JOIST - VIGA ORTOGONAL

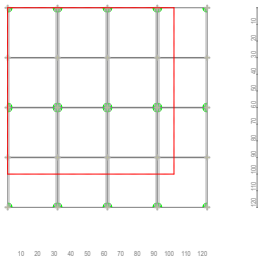

numero basamenti al m2	5,56
ml travetto al m2	3,33
ml profilo silenziatore al m2	6,66
numero elemento fuga al m2	11,11
number of supports per m2	5,56
lm joist per m2	3,33
lm silencer profile per m2	6,66
number of spacer element per m2	11,11
número soportes por m2	5,56
ml viga por m2	3,33
ml perfil de almohadilla por m2	6,66
número elemento junta por m2	11,11

PERIMETRALI - PERIMETRAL - PERIMATRALES
TRAVETTO REGOLARE - REGULAR JOIST - VIGA REGULAR

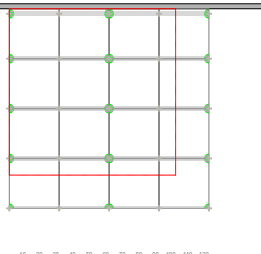

numero basamenti al m2	6,25
ml travetto al m2	3,75
ml profilo silenziatore al m2	7,50
numero elemento fuga al m2	12,50
number of supports per m2	6,25
lm joist per m2	3,75
lm silencer profile per m2	7,50
number of spacer element per m2	12,50
número soportes por m2	6,25
ml viga por m2	3,75
ml perfil de almohadilla por m2	7,50
número elemento junta por m2	12,50

PERIMETRALI - PERIMETRAL - PERIMATRALES
TRAVETTO ORTOGONALE - ORTHOGONAL JOIST - VIGA ORTOGONAL

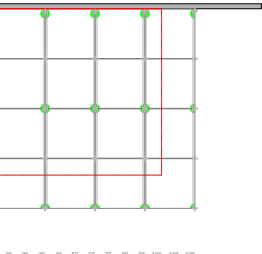

numero basamenti al m2	6,94
ml travetto al m2	3,33
ml profilo silenziatore al m2	6,66
numero elemento fuga al m2	12,50
number of supports per m2	6,94
lm joist per m2	3,33
lm silencer profile per m2	6,66
number of spacer element per m2	12,50
número soportes por m2	6,94
ml viga por m2	3,33
ml perfil de almohadilla por m2	6,66
número elemento junta por m2	12,50

ANGOLARI - ANGULAR - ANGULARES
TRAVETTO REGOLARE - REGULAR JOIST - VIGA REGULAR

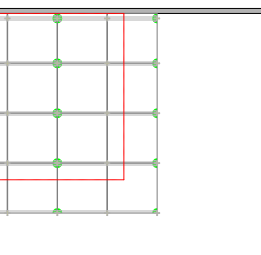

numero basamenti al m2	7,81
ml travetto al m2	3,75
ml profilo silenziatore al m2	7,50
numero elemento fuga al m2	13,37
number of supports per m2	7,81
lm joist per m2	3,75
lm silencer profile per m2	7,50
number of spacer element per m2	13,37
número soportes por m2	7,81
ml viga por m2	3,75
ml perfil de almohadilla por m2	7,50
número elemento junta por m2	13,37

ANGOLARI - ANGULAR - ANGULARES
TRAVETTO ORTOGONALE - ORTHOGONAL JOIST - VIGA ORTOGONAL

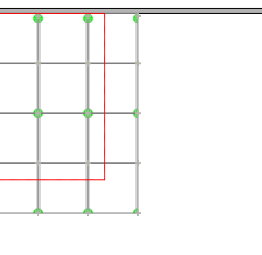

numero basamenti al m2	7,81
ml travetto al m2	3,75
ml profilo silenziatore al m2	7,50
numero elemento fuga al m2	13,37
number of supports per m2	7,81
lm joist per m2	3,75
lm silencer profile per m2	7,50
number of spacer element per m2	13,37
número soportes por m2	7,81
ml viga por m2	3,75
ml perfil de almohadilla por m2	7,50
número elemento junta por m2	13,37

LEGENDA - LEGEND - LEGENDA

 1 mq 1 sq. m 1 mc	 Linea perimetrale Perimetral line Línea perimetral	 Linea d'angolo Corner line Línea de ángulo	 Basamento Support Soporte	 Elemento fuga Spacer element Elemento junta	 Travetto Joist Viga
---	--	--	---	---	---

I quantitativi possono variare in funzione dell'area da pavimentare.
Quantities can varied based on the geometry of the area to be paved.
Las cantidades pueden variar de acuerdo con la zona que se deba solar.

FORMATO QUADRATO - SQUARE SHAPED - FORMATO CUADRADO

40 x 40 cm

CENTRALI - CENTRAL - CENTRALES
TRAVETTO REGOLARE - REGULAR JOIST - VIGA REGULAR

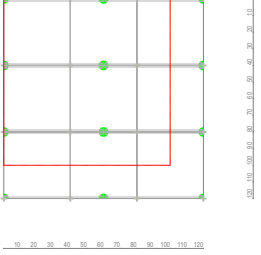

numero basamenti al m2	4,17
ml travetto al m2	2,50
ml profilo silenziatore al m2	5,00
numero elemento fuga al m2	6,25
number of supports per m2	4,17
lm joist per m2	2,50
lm silencer profile per m2	5,00
number of spacer element per m2	6,25
número soportes por m2	4,17
ml viga por m2	2,50
ml perfil de almohadilla por m2	5,00
número elemento junta por m2	6,25

CENTRALI - CENTRAL - CENTRALES
TRAVETTO ORTOGONALE - ORTHOGONAL JOIST - VIGA ORTOGONAL

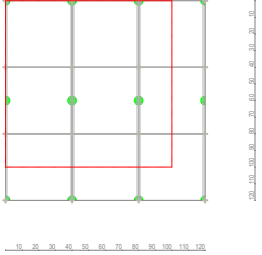

numero basamenti al m2	4,17
ml travetto al m2	2,50
ml profilo silenziatore al m2	5,00
numero elemento fuga al m2	6,25
number of supports per m2	4,17
lm joist per m2	2,50
lm silencer profile per m2	5,00
number of spacer element per m2	6,25
número soportes por m2	4,17
ml viga por m2	2,50
ml perfil de almohadilla por m2	5,00
número elemento junta por m2	6,25

PERIMETRALI - PERIMETRAL - PERIMATRALES
TRAVETTO REGOLARE - REGULAR JOIST - VIGA REGULAR

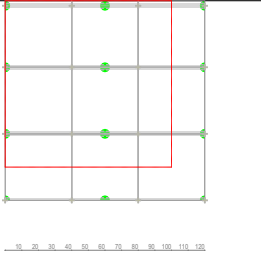

numero basamenti al m2	4,86
ml travetto al m2	2,92
ml profilo silenziatore al m2	5,84
numero elemento fuga al m2	7,29
number of supports per m2	4,86
lm joist per m2	2,92
lm silencer profile per m2	5,84
number of spacer element per m2	7,29
número soportes por m2	4,86
ml viga por m2	2,92
ml perfil de almohadilla por m2	5,84
número elemento junta por m2	7,29

PERIMETRALI - PERIMETRAL - PERIMATRALES
TRAVETTO ORTOGONALE - ORTHOGONAL JOIST - VIGA ORTOGONAL

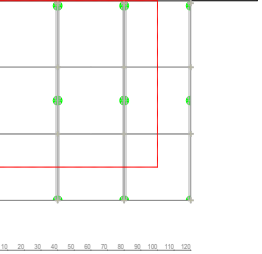

numero basamenti al m2	5,21
ml travetto al m2	2,50
ml profilo silenziatore al m2	5,00
numero elemento fuga al m2	7,29
number of supports per m2	5,21
lm joist per m2	2,50
lm silencer profile per m2	5,00
number of spacer element per m2	7,29
número soportes por m2	5,21
ml viga por m2	2,50
ml perfil de almohadilla por m2	5,00
número elemento junta por m2	7,29

ANGOLARI - ANGULAR - ANGULARES
TRAVETTO REGOLARE - REGULAR JOIST - VIGA REGULAR

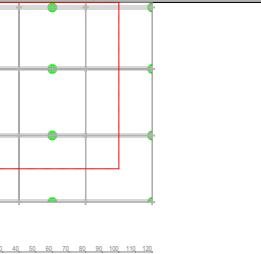

numero basamenti al m2	6,08
ml travetto al m2	2,92
ml profilo silenziatore al m2	5,84
numero elemento fuga al m2	7,81
number of supports per m2	6,08
lm joist per m2	2,92
lm silencer profile per m2	5,84
number of spacer element per m2	7,81
número soportes por m2	6,08
ml viga por m2	2,92
ml perfil de almohadilla por m2	5,84
número elemento junta por m2	7,81

ANGOLARI - ANGULAR - ANGULARES
TRAVETTO ORTOGONALE - ORTHOGONAL JOIST - VIGA ORTOGONAL

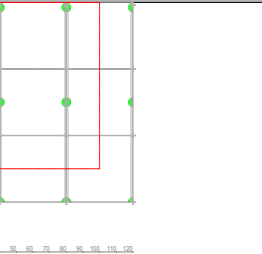

numero basamenti al m2	6,08
ml travetto al m2	2,92
ml profilo silenziatore al m2	5,84
numero elemento fuga al m2	7,81
number of supports per m2	6,08
lm joist per m2	2,92
lm silencer profile per m2	5,84
number of spacer element per m2	7,81
número soportes por m2	6,08
ml viga por m2	2,92
ml perfil de almohadilla por m2	5,84
número elemento junta por m2	7,81

LEGENDA - LEGEND - LEGENDA

 1 mq 1 sq. m 1 mc	 Linea perimetrale Perimetral line Línea perimetral	 Linea d'angolo Corner line Línea de ángulo	 Basamento Support Soporte	 Elemento fuga Spacer element Elemento junta	 Travetto Joist Viga
---	--	--	---	---	---

I quantitativi possono variare in funzione dell'area da pavimentare.
Quantities can varied based on the geometry of the area to be paved.
Las cantidades pueden variar de acuerdo con la zona que se deba solar.

FORMATO QUADRATO - SQUARE SHAPED - FORMATO CUADRADO

45 x 45 cm

CENTRALI - CENTRAL - CENTRALES
TRAVETTO REGOLARE - REGULAR JOIST - VIGA REGULAR

numero basamenti al m2	3,70
ml travetto al m2	2,22
ml profilo silenziatore al m2	4,44
numero elemento fuga al m2	4,94
number of supports per m2	3,70
lm joist per m2	2,22
lm silencer profile per m2	4,44
number of spacer element per m2	4,94
número soportes por m2	3,70
ml viga por m2	2,22
ml perfil de almohadilla por m2	4,44
número elemento junta por m2	4,94

CENTRALI - CENTRAL - CENTRALES
TRAVETTO ORTOGONALE - ORTHOGONAL JOIST - VIGA ORTOGONAL

numero basamenti al m2	3,70
ml travetto al m2	2,22
ml profilo silenziatore al m2	4,44
numero elemento fuga al m2	4,94
number of supports per m2	3,70
lm joist per m2	2,22
lm silencer profile per m2	4,44
number of spacer element per m2	4,94
número soportes por m2	3,70
ml viga por m2	2,22
ml perfil de almohadilla por m2	4,44
número elemento junta por m2	4,94

PERIMETRALI - PERIMETRAL - PERIMATRALES
TRAVETTO REGOLARE - REGULAR JOIST - VIGA REGULAR

numero basamenti al m2	4,32
ml travetto al m2	2,59
ml profilo silenziatore al m2	5,18
numero elemento fuga al m2	5,76
number of supports per m2	4,32
lm joist per m2	2,59
lm silencer profile per m2	5,18
number of spacer element per m2	5,76
número soportes por m2	4,32
ml viga por m2	2,59
ml perfil de almohadilla por m2	5,18
número elemento junta por m2	5,76

PERIMETRALI - PERIMETRAL - PERIMATRALES
TRAVETTO ORTOGONALE - ORTHOGONAL JOIST - VIGA ORTOGONAL

numero basamenti al m2	4,32
ml travetto al m2	2,22
ml profilo silenziatore al m2	4,44
numero elemento fuga al m2	5,76
number of supports per m2	4,32
lm joist per m2	2,22
lm silencer profile per m2	4,44
number of spacer element per m2	5,76
número soportes por m2	4,32
ml viga por m2	2,22
ml perfil de almohadilla por m2	4,44
número elemento junta por m2	5,76

ANGOLARI - ANGULAR - ANGULARES
TRAVETTO REGOLARE - REGULAR JOIST - VIGA REGULAR

numero basamenti al m2	5,04
ml travetto al m2	2,59
ml profilo silenziatore al m2	5,18
numero elemento fuga al m2	6,07
number of supports per m2	5,04
lm joist per m2	2,59
lm silencer profile per m2	5,18
number of spacer element per m2	6,07
número soportes por m2	5,04
ml viga por m2	2,59
ml perfil de almohadilla por m2	5,18
número elemento junta por m2	6,07

ANGOLARI - ANGULAR - ANGULARES
TRAVETTO ORTOGONALE - ORTHOGONAL JOIST - VIGA ORTOGONAL

numero basamenti al m2	5,04
ml travetto al m2	2,59
ml profilo silenziatore al m2	5,18
numero elemento fuga al m2	6,07
number of supports per m2	5,04
lm joist per m2	2,59
lm silencer profile per m2	5,18
number of spacer element per m2	6,07
número soportes por m2	5,04
ml viga por m2	2,59
ml perfil de almohadilla por m2	5,18
número elemento junta por m2	6,07

LEGENDA - LEGEND - LEGENDA

1 mq 1 sq. m 1 mc	Linea perimetrale Perimetral line Línea perimetral	Linea d'angolo Corner line Línea de ángulo	Basamento Support Soporte	Elemento fuga Spacer element Elemento junta	Travetto Joist Viga
-------------------------	--	--	---------------------------------	---	---------------------------

I quantitativi possono variare in funzione dell'area da pavimentare.
Quantities can varied based on the geometry of the area to be paved.
Las cantidades pueden variar de acuerdo con la zona que se deba solar.

FORMATO QUADRATO - SQUARE SHAPED - FORMATO CUADRADO

50 x 50 cm

CENTRALI - CENTRAL - CENTRALES
TRAVETTO REGOLARE - REGULAR JOIST - VIGA REGULAR

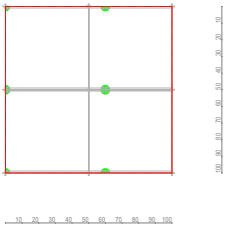

numero basamenti al m2	3,33
ml travetto al m2	2,00
ml profilo silenziatore al m2	4,00
numero elemento fuga al m2	4,00
number of supports per m2	3,33
lm joist per m2	2,00
lm silencer profile per m2	4,00
number of spacer element per m2	4,00
número soportes por m2	3,33
ml viga por m2	2,00
ml perfil de almohadilla por m2	4,00
número elemento junta por m2	4,00

CENTRALI - CENTRAL - CENTRALES
TRAVETTO ORTOGONALE - ORTHOGONAL JOIST - VIGA ORTOGONAL

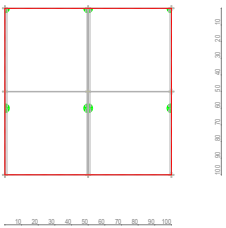

numero basamenti al m2	3,33
ml travetto al m2	2,00
ml profilo silenziatore al m2	4,00
numero elemento fuga al m2	4,00
number of supports per m2	3,33
lm joist per m2	2,00
lm silencer profile per m2	4,00
number of spacer element per m2	4,00
número soportes por m2	3,33
ml viga por m2	2,00
ml perfil de almohadilla por m2	4,00
número elemento junta por m2	4,00

PERIMETRALI - PERIMETRAL - PERIMATRALES
TRAVETTO REGOLARE - REGULAR JOIST - VIGA REGULAR

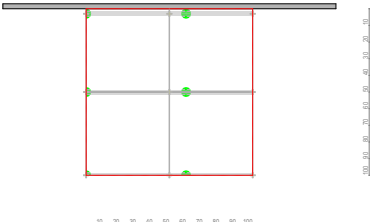

numero basamenti al m2	4,17
ml travetto al m2	2,50
ml profilo silenziatore al m2	5,00
numero elemento fuga al m2	5,00
number of supports per m2	4,17
lm joist per m2	2,50
lm silencer profile per m2	5,00
number of spacer element per m2	5,00
número soportes por m2	4,17
ml viga por m2	2,50
ml perfil de almohadilla por m2	5,00
número elemento junta por m2	5,00

PERIMETRALI - PERIMETRAL - PERIMATRALES
TRAVETTO ORTOGONALE - ORTHOGONAL JOIST - VIGA ORTOGONAL

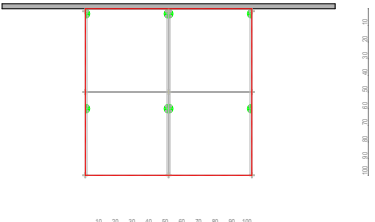

numero basamenti al m2	4,17
ml travetto al m2	2,50
ml profilo silenziatore al m2	5,00
numero elemento fuga al m2	5,00
number of supports per m2	4,17
lm joist per m2	2,50
lm silencer profile per m2	5,00
number of spacer element per m2	5,00
número soportes por m2	4,17
ml viga por m2	2,50
ml perfil de almohadilla por m2	5,00
número elemento junta por m2	5,00

ANGOLARI - ANGULAR - ANGULARES
TRAVETTO REGOLARE - REGULAR JOIST - VIGA REGULAR

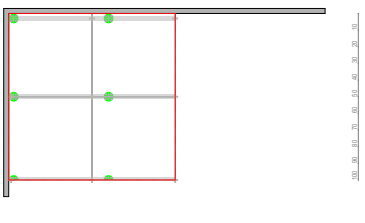

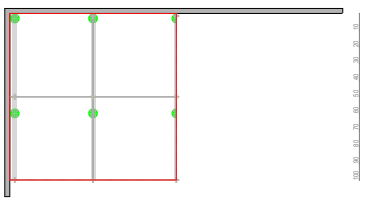

numero basamenti al m2	4,58
ml travetto al m2	2,50
ml profilo silenziatore al m2	5,00
numero elemento fuga al m2	4,92
number of supports per m2	4,58
lm joist per m2	2,50
lm silencer profile per m2	5,00
number of spacer element per m2	4,92
número soportes por m2	4,58
ml viga por m2	2,50
ml perfil de almohadilla por m2	5,00
número elemento junta por m2	4,92

ANGOLARI - ANGULAR - ANGULARES
TRAVETTO ORTOGONALE - ORTHOGONAL JOIST - VIGA ORTOGONAL



numero basamenti al m2	4,58
ml travetto al m2	2,50
ml profilo silenziatore al m2	5,00
numero elemento fuga al m2	4,92
number of supports per m2	4,58
lm joist per m2	2,50
lm silencer profile per m2	5,00
number of spacer element per m2	4,92
número soportes por m2	4,58
ml viga por m2	2,50
ml perfil de almohadilla por m2	5,00
número elemento junta por m2	4,92

LEGENDA - LEGEND - LEGENDA

 1 mq 1 sq. m 1 mc	 Linea perimetrale Perimetral line Línea perimetral	 Linea d'angolo Corner line Línea de ángulo	 Basamento Support Soporte	 Elemento fuga Spacer element Elemento junta	 Travetto Joist Viga
---	--	--	---	---	---

I quantitativi possono variare in funzione dell'area da pavimentare.
Quantities can varied based on the geometry of the area to be paved.
Las cantidades pueden variar de acuerdo con la zona que se deba solar.

FORMATO QUADRATO - SQUARE SHAPED - FORMATO CUADRADO

60 x 60 cm

CENTRALI - CENTRAL - CENTRALES
TRAVETTO REGOLARE - REGULAR JOIST - VIGA REGULAR

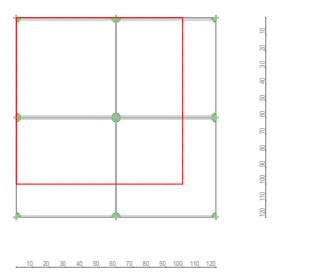

numero basamenti al m2	2,78
ml travetto al m2	1,67
ml profilo silenziatore al m2	3,34
numero elemento fuga al m2	2,78
number of supports per m2	2,78
lm joist per m2	1,67
lm silencer profile per m2	3,34
number of spacer element per m2	2,78
número soportes por m2	2,78
ml viga por m2	1,67
ml perfil de almohadilla por m2	3,34
número elemento junta por m2	2,78

CENTRALI - CENTRAL - CENTRALES
TRAVETTO ORTOGONALE - ORTHOGONAL JOIST - VIGA ORTOGONAL

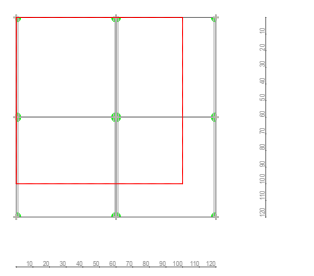

numero basamenti al m2	2,78
ml travetto al m2	1,67
ml profilo silenziatore al m2	3,34
numero elemento fuga al m2	2,78
number of supports per m2	2,78
lm joist per m2	1,67
lm silencer profile per m2	3,34
number of spacer element per m2	2,78
número soportes por m2	2,78
ml viga por m2	1,67
ml perfil de almohadilla por m2	3,34
número elemento junta por m2	2,78

PERIMETRALI - PERIMETRAL - PERIMATRALES
TRAVETTO REGOLARE - REGULAR JOIST - VIGA REGULAR

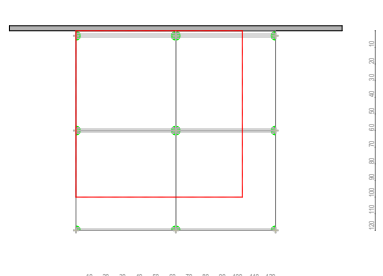

numero basamenti al m2	3,47
ml travetto al m2	2,08
ml profilo silenziatore al m2	4,16
numero elemento fuga al m2	3,47
number of supports per m2	3,47
lm joist per m2	2,08
lm silencer profile per m2	4,16
number of spacer element per m2	3,47
número soportes por m2	3,47
ml viga por m2	2,08
ml perfil de almohadilla por m2	4,16
número elemento junta por m2	3,47

PERIMETRALI - PERIMETRAL - PERIMATRALES
TRAVETTO ORTOGONALE - ORTHOGONAL JOIST - VIGA ORTOGONAL

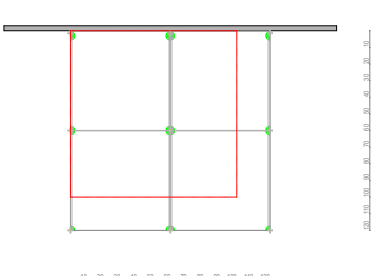

numero basamenti al m2	3,47
ml travetto al m2	1,67
ml profilo silenziatore al m2	3,34
numero elemento fuga al m2	3,47
number of supports per m2	3,47
lm joist per m2	1,67
lm silencer profile per m2	3,34
number of spacer element per m2	3,47
número soportes por m2	3,47
ml viga por m2	1,67
ml perfil de almohadilla por m2	3,34
número elemento junta por m2	3,47

ANGOLARI - ANGULAR - ANGULARES
TRAVETTO REGOLARE - REGULAR JOIST - VIGA REGULAR

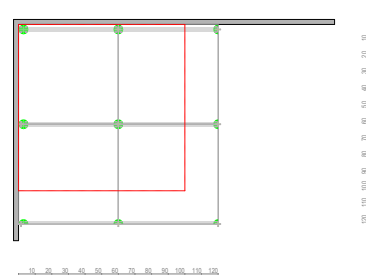





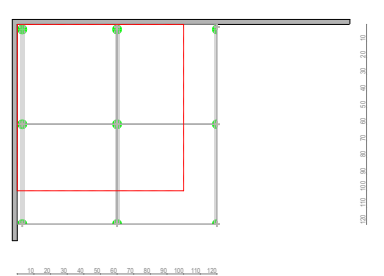

numero basamenti al m2	4,34
ml travetto al m2	2,08
ml profilo silenziatore al m2	4,16
numero elemento fuga al m2	3,65
number of supports per m2	4,34
lm joist per m2	2,08
lm silencer profile per m2	4,16
number of spacer element per m2	3,65
número soportes por m2	4,34
ml viga por m2	2,08
ml perfil de almohadilla por m2	4,16
número elemento junta por m2	3,65

ANGOLARI - ANGULAR - ANGULARES
TRAVETTO ORTOGONALE - ORTHOGONAL JOIST - VIGA ORTOGONAL



numero basamenti al m2	4,34
ml travetto al m2	2,08
ml profilo silenziatore al m2	4,16
numero elemento fuga al m2	3,65
number of supports per m2	4,34
lm joist per m2	2,08
lm silencer profile per m2	4,16
number of spacer element per m2	3,65
número soportes por m2	4,34
ml viga por m2	2,08
ml perfil de almohadilla por m2	4,16
número elemento junta por m2	3,65

LEGENDA - LEGEND - LEGENDA

 1 mq 1 sq. m 1 mc	 Linea perimetrale Perimetral line Línea perimetral	 Linea d'angolo Corner line Línea de ángulo	 Basamento Support Soporte	 Elemento fuga Spacer element Elemento junta	 Travetto Joist Viga
---	--	--	---	---	---

I quantitativi possono variare in funzione dell'area da pavimentare.
Quantities can varied based on the geometry of the area to be paved.
Las cantidades pueden variar de acuerdo con la zona que se deba solar.

FORMATO QUADRATO - SQUARE SHAPED - FORMATO CUADRADO

75 x 75 cm

CENTRALI - CENTRAL - CENTRALES
TRAVETTO REGOLARE - REGULAR JOIST - VIGA REGULAR

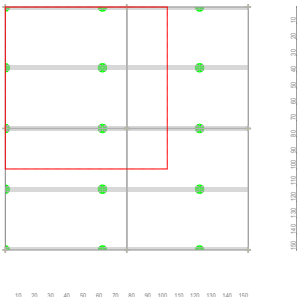

numero basamenti al m2	4,44
ml travetto al m2	2,67
ml profilo silenziatore al m2	5,34
numero elemento fuga al m2	1,78
number of supports per m2	4,44
lm joist per m2	2,67
lm silencer profile per m2	5,34
number of spacer element per m2	1,78
número soportes por m2	4,44
ml viga por m2	2,67
ml perfil de almohadilla por m2	5,34
número elemento junta por m2	1,78

CENTRALI - CENTRAL - CENTRALES
TRAVETTO ORTOGONALE - ORTHOGONAL JOIST - VIGA ORTOGONAL

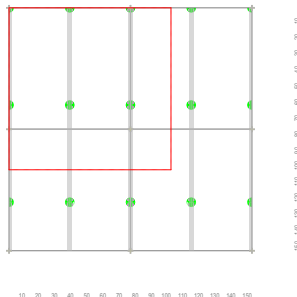

numero basamenti al m2	4,44
ml travetto al m2	2,67
ml profilo silenziatore al m2	5,34
numero elemento fuga al m2	1,78
number of supports per m2	4,44
lm joist per m2	2,67
lm silencer profile per m2	5,34
number of spacer element per m2	1,78
número soportes por m2	4,44
ml viga por m2	2,67
ml perfil de almohadilla por m2	5,34
número elemento junta por m2	1,78

PERIMETRALI - PERIMETRAL - PERIMATRALES
TRAVETTO REGOLARE - REGULAR JOIST - VIGA REGULAR

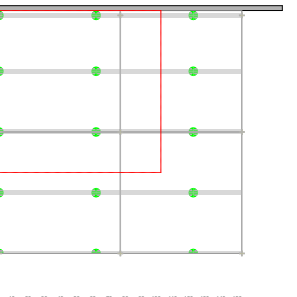

numero basamenti al m2	5,00
ml travetto al m2	3,00
ml profilo silenziatore al m2	6,00
numero elemento fuga al m2	2,22
number of supports per m2	5,00
lm joist per m2	3,00
lm silencer profile per m2	6,00
number of spacer element per m2	2,22
número soportes por m2	5,00
ml viga por m2	3,00
ml perfil de almohadilla por m2	6,00
número elemento junta por m2	2,22

PERIMETRALI - PERIMETRAL - PERIMATRALES
TRAVETTO ORTOGONALE - ORTHOGONAL JOIST - VIGA ORTOGONAL

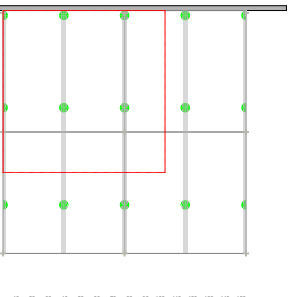

numero basamenti al m2	4,89
ml travetto al m2	2,67
ml profilo silenziatore al m2	5,34
numero elemento fuga al m2	2,22
number of supports per m2	4,89
lm joist per m2	2,67
lm silencer profile per m2	5,34
number of spacer element per m2	2,22
número soportes por m2	4,89
ml viga por m2	2,67
ml perfil de almohadilla por m2	5,34
número elemento junta por m2	2,22

ANGOLARI - ANGULAR - ANGULARES
TRAVETTO REGOLARE - REGULAR JOIST - VIGA REGULAR

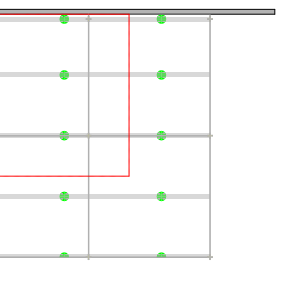

numero basamenti al m2	5,50
ml travetto al m2	3,00
ml profilo silenziatore al m2	6,00
numero elemento fuga al m2	2,28
number of supports per m2	5,50
lm joist per m2	3,00
lm silencer profile per m2	6,00
number of spacer element per m2	2,28
número soportes por m2	5,50
ml viga por m2	3,00
ml perfil de almohadilla por m2	6,00
número elemento junta por m2	2,28

ANGOLARI - ANGULAR - ANGULARES
TRAVETTO ORTOGONALE - ORTHOGONAL JOIST - VIGA ORTOGONAL

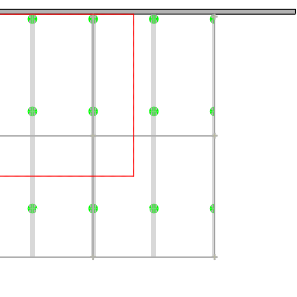

numero basamenti al m2	5,50
ml travetto al m2	3,00
ml profilo silenziatore al m2	6,00
numero elemento fuga al m2	2,28
number of supports per m2	5,50
lm joist per m2	3,00
lm silencer profile per m2	6,00
number of spacer element per m2	2,28
número soportes por m2	5,50
ml viga por m2	3,00
ml perfil de almohadilla por m2	6,00
número elemento junta por m2	2,28

LEGENDA - LEGEND - LEGENDA

 1 mq 1 sq. m 1 mc	 Linea perimetrale Perimetral line Línea perimetral	 Linea d'angolo Corner line Línea de ángulo	 Basamento Support Soporte	 Elemento fuga Spacer element Elemento junta	 Travetto Joist Viga
---	--	--	---	---	---

I quantitativi possono variare in funzione dell'area da pavimentare.
 Quantities can varied based on the geometry of the area to be paved.
 Las cantidades pueden variar de acuerdo con la zona que se deba solar.

FORMATO QUADRATO - SQUARE SHAPED - FORMATO CUADRADO

80 x 80 cm

CENTRALI - CENTRAL - CENTRALES
TRAVETTO REGOLARE - REGULAR JOIST - VIGA REGULAR

numero basamenti al m ²	4,17
ml travetto al m ²	2,50
ml profilo silenziatore al m ²	5,00
numero elemento fuga al m ²	1,56
number of supports per m ²	4,17
lm joist per m ²	2,50
lm silencer profile per m ²	5,00
number of spacer element per m ²	1,56
número soportes por m ²	4,17
ml viga por m ²	2,50
ml perfil de almohadilla por m ²	5,00
número elemento junta por m ²	1,56

CENTRALI - CENTRAL - CENTRALES
TRAVETTO ORTOGONALE - ORTHOGONAL JOIST - VIGA ORTOGONAL

numero basamenti al m ²	4,17
ml travetto al m ²	2,50
ml profilo silenziatore al m ²	5,00
numero elemento fuga al m ²	1,56
number of supports per m ²	4,17
lm joist per m ²	2,50
lm silencer profile per m ²	5,00
number of spacer element per m ²	1,56
número soportes por m ²	4,17
ml viga por m ²	2,50
ml perfil de almohadilla por m ²	5,00
número elemento junta por m ²	1,56

PERIMETRALI - PERIMETRAL - PERIMATRALES
TRAVETTO REGOLARE - REGULAR JOIST - VIGA REGULAR

numero basamenti al m ²	4,69
ml travetto al m ²	2,81
ml profilo silenziatore al m ²	5,62
numero elemento fuga al m ²	1,95
number of supports per m ²	4,69
lm joist per m ²	2,81
lm silencer profile per m ²	5,62
number of spacer element per m ²	1,95
número soportes por m ²	4,69
ml viga por m ²	2,81
ml perfil de almohadilla por m ²	5,62
número elemento junta por m ²	1,95

PERIMETRALI - PERIMETRAL - PERIMATRALES
TRAVETTO ORTOGONALE - ORTHOGONAL JOIST - VIGA ORTOGONAL

numero basamenti al m ²	4,69
ml travetto al m ²	2,50
ml profilo silenziatore al m ²	5,00
numero elemento fuga al m ²	1,95
number of supports per m ²	4,69
lm joist per m ²	2,50
lm silencer profile per m ²	5,00
number of spacer element per m ²	1,95
número soportes por m ²	4,69
ml viga por m ²	2,50
ml perfil de almohadilla por m ²	5,00
número elemento junta por m ²	1,95

ANGOLARI - ANGULAR - ANGULARES
TRAVETTO REGOLARE - REGULAR JOIST - VIGA REGULAR

numero basamenti al m ²	5,27
ml travetto al m ²	2,81
ml profilo silenziatore al m ²	5,62
numero elemento fuga al m ²	2,02
number of supports per m ²	5,27
lm joist per m ²	2,81
lm silencer profile per m ²	5,62
number of spacer element per m ²	2,02
número soportes por m ²	5,27
ml viga por m ²	2,81
ml perfil de almohadilla por m ²	5,62
número elemento junta por m ²	2,02

ANGOLARI - ANGULAR - ANGULARES
TRAVETTO ORTOGONALE - ORTHOGONAL JOIST - VIGA ORTOGONAL

numero basamenti al m ²	5,27
ml travetto al m ²	2,81
ml profilo silenziatore al m ²	5,62
numero elemento fuga al m ²	2,02
number of supports per m ²	5,27
lm joist per m ²	2,81
lm silencer profile per m ²	5,62
number of spacer element per m ²	2,02
número soportes por m ²	5,27
ml viga por m ²	2,81
ml perfil de almohadilla por m ²	5,62
número elemento junta por m ²	2,02

LEGENDA - LEGEND - LEGENDA

1 mq 1 sq. m 1 mc	Linea perimetrale Perimetral line Línea perimetral	Linea d'angolo Corner line Línea de ángulo	Basamento Support Soporte	Elemento fuga Spacer element Elemento junta	Travetto Joist Viga
-------------------------	--	--	---------------------------------	---	---------------------------

I quantitativi possono variare in funzione dell'area da pavimentare.
Quantities can varied based on the geometry of the area to be paved.
Las cantidades pueden variar de acuerdo con la zona que se deba solar.

FORMATO QUADRATO - SQUARE SHAPED - FORMATO CUADRADO

90 x 90 cm

CENTRALI - CENTRAL - CENTRALES
TRAVETTO REGOLARE - REGULAR JOIST - VIGA REGULAR

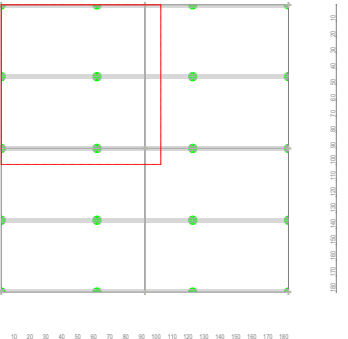

numero basamenti al m2	3,70
ml travetto al m2	2,22
ml profilo silenziatore al m2	4,44
numero elemento fuga al m2	1,23
number of supports per m2	3,70
lm joist per m2	2,22
lm silencer profile per m2	4,44
number of spacer element per m2	1,23
número soportes por m2	3,70
ml viga por m2	2,22
ml perfil de almohadilla por m2	4,44
número elemento junta por m2	1,23

CENTRALI - CENTRAL - CENTRALES
TRAVETTO ORTOGONALE - ORTHOGONAL JOIST - VIGA ORTOGONAL

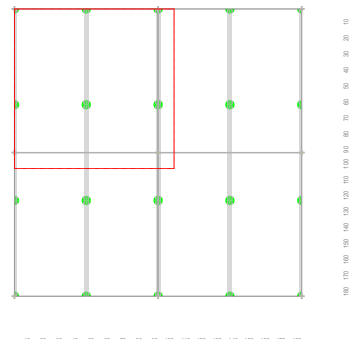

numero basamenti al m2	3,70
ml travetto al m2	2,22
ml profilo silenziatore al m2	4,44
numero elemento fuga al m2	1,23
number of supports per m2	3,70
lm joist per m2	2,22
lm silencer profile per m2	4,44
number of spacer element per m2	1,23
número soportes por m2	3,70
ml viga por m2	2,22
ml perfil de almohadilla por m2	4,44
número elemento junta por m2	1,23

PERIMETRALI - PERIMETRAL - PERIMATRALES
TRAVETTO REGOLARE - REGULAR JOIST - VIGA REGULAR

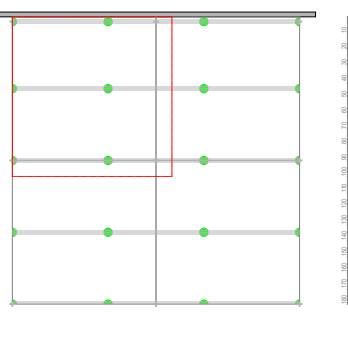

numero basamenti al m2	4,17
ml travetto al m2	2,50
ml profilo silenziatore al m2	5,00
numero elemento fuga al m2	1,54
number of supports per m2	4,17
lm joist per m2	2,50
lm silencer profile per m2	5,00
number of spacer element per m2	1,54
número soportes por m2	4,17
ml viga por m2	2,50
ml perfil de almohadilla por m2	5,00
número elemento junta por m2	1,54

PERIMETRALI - PERIMETRAL - PERIMATRALES
TRAVETTO ORTOGONALE - ORTHOGONAL JOIST - VIGA ORTOGONAL

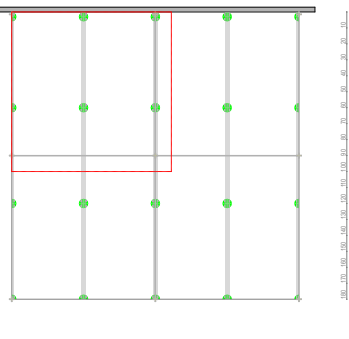

numero basamenti al m2	4,32
ml travetto al m2	2,22
ml profilo silenziatore al m2	4,44
numero elemento fuga al m2	1,54
number of supports per m2	4,32
lm joist per m2	2,22
lm silencer profile per m2	4,44
number of spacer element per m2	1,54
número soportes por m2	4,32
ml viga por m2	2,22
ml perfil de almohadilla por m2	4,44
número elemento junta por m2	1,54

ANGOLARI - ANGULAR - ANGULARES
TRAVETTO REGOLARE - REGULAR JOIST - VIGA REGULAR

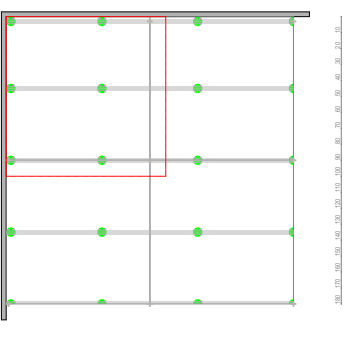

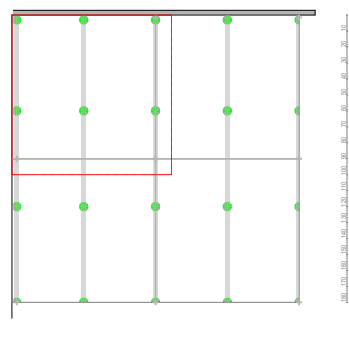

numero basamenti al m2	4,86
ml travetto al m2	2,50
ml profilo silenziatore al m2	5,00
numero elemento fuga al m2	1,62
number of supports per m2	4,86
lm joist per m2	2,50
lm silencer profile per m2	5,00
number of spacer element per m2	1,62
número soportes por m2	4,86
ml viga por m2	2,50
ml perfil de almohadilla por m2	5,00
número elemento junta por m2	1,62

ANGOLARI - ANGULAR - ANGULARES
TRAVETTO ORTOGONALE - ORTHOGONAL JOIST - VIGA ORTOGONAL



numero basamenti al m2	4,86
ml travetto al m2	2,50
ml profilo silenziatore al m2	5,00
numero elemento fuga al m2	1,62
number of supports per m2	4,86
lm joist per m2	2,50
lm silencer profile per m2	5,00
number of spacer element per m2	1,62
número soportes por m2	4,86
ml viga por m2	2,50
ml perfil de almohadilla por m2	5,00
número elemento junta por m2	1,62

LEGENDA - LEGEND - LEGENDA





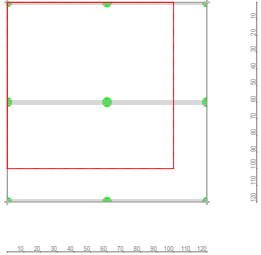
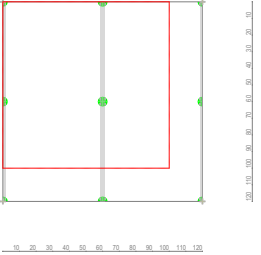
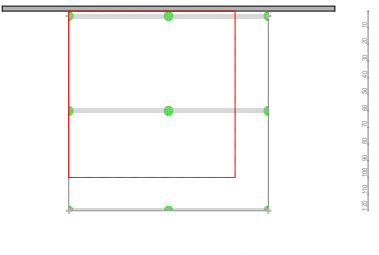
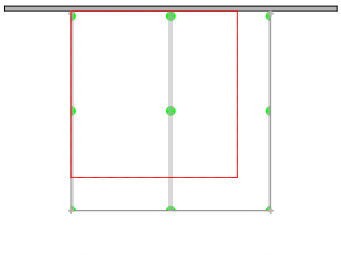
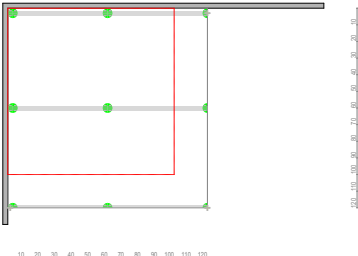
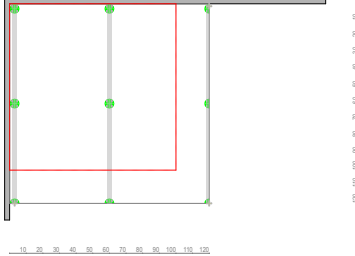

 1 mq 1 sq. m 1 mc	 Linea perimetrale Perimetral line Línea perimetral	 Linea d'angolo Corner line Línea de ángulo	 Basamento Support Soporte	 Elemento fuga Spacer element Elemento junta	 Travetto Joist Viga
---	--	--	---	---	---

I quantitativi possono variare in funzione dell'area da pavimentare.
Quantities can varied based on the geometry of the area to be paved.
Las cantidades pueden variar de acuerdo con la zona que se deba solar.

FORMATO QUADRATO - SQUARE SHAPED - FORMATO CUADRADO

120 x 120 cm

CENTRALI - CENTRAL - CENTRALES TRAVETTO REGOLARE - REGULAR JOIST - VIGA REGULAR		CENTRALI - CENTRAL - CENTRALES TRAVETTO ORTOGONALE - ORTHOGONAL JOIST - VIGA ORTOGONAL	
	numero basamenti al m2 2,78 ml travetto al m2 1,67 ml profilo silenziatore al m2 3,34 numero elemento fuga al m2 0,69 number of supports per m2 2,78 lm joist per m2 1,67 lm silencer profile per m2 3,34 number of spacer element per m2 0,69 número soportes por m2 2,78 ml viga por m2 1,67 ml perfil de almohadilla por m2 3,34 número elemento junta por m2 0,69		numero basamenti al m2 2,78 ml travetto al m2 1,67 ml profilo silenziatore al m2 3,34 numero elemento fuga al m2 0,69 number of supports per m2 2,78 lm joist per m2 1,67 lm silencer profile per m2 3,34 number of spacer element per m2 0,69 número soportes por m2 2,78 ml viga por m2 1,67 ml perfil de almohadilla por m2 3,34 número elemento junta por m2 0,69
PERIMETRALI - PERIMETRAL - PERIMATRALES TRAVETTO REGOLARE - REGULAR JOIST - VIGA REGULAR		PERIMETRALI - PERIMETRAL - PERIMATRALES TRAVETTO ORTOGONALE - ORTHOGONAL JOIST - VIGA ORTOGONAL	
	numero basamenti al m2 3,47 ml travetto al m2 2,08 ml profilo silenziatore al m2 4,16 numero elemento fuga al m2 1,04 number of supports per m2 3,47 lm joist per m2 2,08 lm silencer profile per m2 4,16 number of spacer element per m2 1,04 número soportes por m2 3,47 ml viga por m2 2,08 ml perfil de almohadilla por m2 4,16 número elemento junta por m2 1,04		numero basamenti al m2 3,47 ml travetto al m2 1,67 ml profilo silenziatore al m2 3,34 numero elemento fuga al m2 1,04 number of supports per m2 3,47 lm joist per m2 1,67 lm silencer profile per m2 3,34 number of spacer element per m2 1,04 número soportes por m2 3,47 ml viga por m2 1,67 ml perfil de almohadilla por m2 3,34 número elemento junta por m2 1,04
ANGOLARI - ANGULAR - ANGULARES TRAVETTO REGOLARE - REGULAR JOIST - VIGA REGULAR		ANGOLARI - ANGULAR - ANGULARES TRAVETTO ORTOGONALE - ORTHOGONAL JOIST - VIGA ORTOGONAL	
	numero basamenti al m2 4,34 ml travetto al m2 2,08 ml profilo silenziatore al m2 4,16 numero elemento fuga al m2 0,87 number of supports per m2 4,34 lm joist per m2 2,08 lm silencer profile per m2 4,16 number of spacer element per m2 0,87 número soportes por m2 4,34 ml viga por m2 2,08 ml perfil de almohadilla por m2 4,16 número elemento junta por m2 0,87		numero basamenti al m2 4,34 ml travetto al m2 2,08 ml profilo silenziatore al m2 4,16 numero elemento fuga al m2 0,87 number of supports per m2 4,34 lm joist per m2 2,08 lm silencer profile per m2 4,16 number of spacer element per m2 0,87 número soportes por m2 4,34 ml viga por m2 2,08 ml perfil de almohadilla por m2 4,16 número elemento junta por m2 0,87

LEGENDA - LEGEND - LEGENDA											
	1 mq 1 sq. m 1 mc		Linea perimetrale Perimetral line Línea perimetral		Linea d'angolo Corner line Línea de ángulo		Basamento Support Soporte		Elemento fuga Spacer element Elemento junta		Travetto Joist Viga

I quantitativi possono variare in funzione dell'area da pavimentare.
 Quantities can varied based on the geometry of the area to be paved.
 Las cantidades pueden variar de acuerdo con la zona que se deba solar.

FORMATO RETTANGOLARE - RECTANGULAR SHAPED - FORMATO RECTANGULAR

30 x 35 cm

CENTRALI - CENTRAL - CENTRALES
TRAVETTO REGOLARE - REGULAR JOIST - VIGA REGULAR

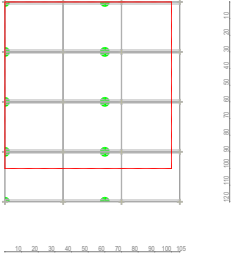

numero basamenti al m2	5,56
ml travetto al m2	3,33
ml profilo silenziatore al m2	6,66
numero elemento fuga al m2	9,52
number of supports per m2	5,56
lm joist per m2	3,33
lm silencer profile per m2	6,66
number of spacer element per m2	9,52
número soportes por m2	5,56
ml viga por m2	3,33
ml perfil de almohadilla por m2	6,66
número elemento junta por m2	9,52

CENTRALI - CENTRAL - CENTRALES
TRAVETTO ORTOGONALE - ORTHOGONAL JOIST - VIGA ORTOGONAL

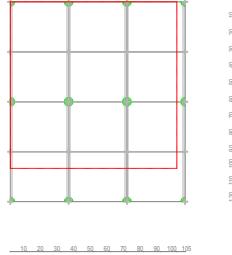

numero basamenti al m2	4,76
ml travetto al m2	2,86
ml profilo silenziatore al m2	5,72
numero elemento fuga al m2	9,52
number of supports per m2	4,76
lm joist per m2	2,86
lm silencer profile per m2	5,72
number of spacer element per m2	9,52
número soportes por m2	4,76
ml viga por m2	2,86
ml perfil de almohadilla por m2	5,72
número elemento junta por m2	9,52

PERIMETRALI - PERIMETRAL - PERIMATRALES
TRAVETTO REGOLARE - REGULAR JOIST - VIGA REGULAR

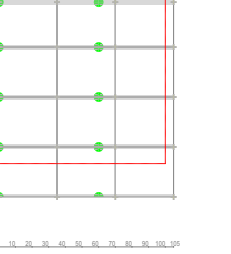

numero basamenti al m2	6,15
ml travetto al m2	3,75
ml profilo silenziatore al m2	7,50
numero elemento fuga al m2	10,61
number of supports per m2	6,15
lm joist per m2	3,75
lm silencer profile per m2	7,50
number of spacer element per m2	10,61
número soportes por m2	6,15
ml viga por m2	3,75
ml perfil de almohadilla por m2	7,50
número elemento junta por m2	10,61

PERIMETRALI - PERIMETRAL - PERIMATRALES
TRAVETTO ORTOGONALE - ORTHOGONAL JOIST - VIGA ORTOGONAL

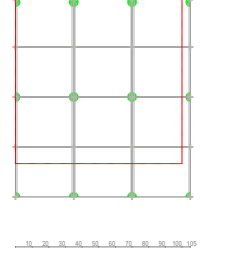

numero basamenti al m2	5,95
ml travetto al m2	2,86
ml profilo silenziatore al m2	5,72
numero elemento fuga al m2	10,71
number of supports per m2	5,95
lm joist per m2	2,86
lm silencer profile per m2	5,72
number of spacer element per m2	10,71
número soportes por m2	5,95
ml viga por m2	2,86
ml perfil de almohadilla por m2	5,72
número elemento junta por m2	10,71

ANGOLARI - ANGULAR - ANGULARES
TRAVETTO REGOLARE - REGULAR JOIST - VIGA REGULAR

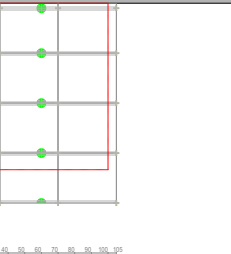





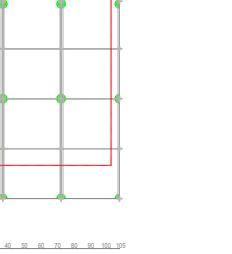

numero basamenti al m2	6,70
ml travetto al m2	3,75
ml profilo silenziatore al m2	7,50
numero elemento fuga al m2	10,96
number of supports per m2	6,70
lm joist per m2	3,75
lm silencer profile per m2	7,50
number of spacer element per m2	10,96
número soportes por m2	6,70
ml viga por m2	3,75
ml perfil de almohadilla por m2	7,50
número elemento junta por m2	10,96

ANGOLARI - ANGULAR - ANGULARES
TRAVETTO ORTOGONALE - ORTHOGONAL JOIST - VIGA ORTOGONAL



numero basamenti al m2	6,94
ml travetto al m2	3,33
ml profilo silenziatore al m2	6,66
numero elemento fuga al m2	11,71
number of supports per m2	6,94
lm joist per m2	3,33
lm silencer profile per m2	6,66
number of spacer element per m2	11,71
número soportes por m2	6,94
ml viga por m2	3,33
ml perfil de almohadilla por m2	6,66
número elemento junta por m2	11,71

LEGENDA - LEGEND - LEGENDA

 1 mq 1 sq. m 1 mc	 Linea perimetrale Perimetral line Línea perimetral	 Linea d'angolo Corner line Línea de ángulo	 Basamento Support Soporte	 Elemento fuga Spacer element Elemento junta	 Travetto Joist Viga
---	--	--	---	---	--

I quantitativi possono variare in funzione dell'area da pavimentare.
Quantities can varied based on the geometry of the area to be paved.
Las cantidades pueden variar de acuerdo con la zona que se deba solar.

FORMATO RETTANGOLARE - RECTANGULAR SHAPED - FORMATO RECTANGULAR

35 x 40 cm

CENTRALI - CENTRAL - CENTRALES
TRAVETTO REGOLARE - REGULAR JOIST - VIGA REGULAR

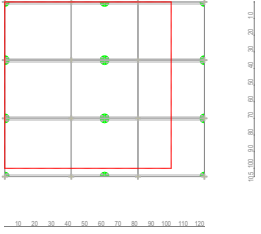

numero basamenti al m2	4,76
ml travetto al m2	2,86
ml profilo silenziatore al m2	5,72
numero elemento fuga al m2	7,14
number of supports per m2	4,76
lm joist per m2	2,86
lm silencer profile per m2	5,72
number of spacer element per m2	7,14
número soportes por m2	4,76
ml viga por m2	2,86
ml perfil de almohadilla por m2	5,72
número elemento junta por m2	7,14

CENTRALI - CENTRAL - CENTRALES
TRAVETTO ORTOGONALE - ORTHOGONAL JOIST - VIGA ORTOGONAL

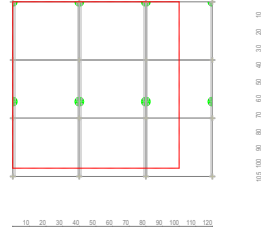

numero basamenti al m2	4,17
ml travetto al m2	2,50
ml profilo silenziatore al m2	5,00
numero elemento fuga al m2	7,44
number of supports per m2	4,17
lm joist per m2	2,50
lm silencer profile per m2	5,00
number of spacer element per m2	7,44
número soportes por m2	4,17
ml viga por m2	2,50
ml perfil de almohadilla por m2	5,00
número elemento junta por m2	7,44

PERIMETRALI - PERIMETRAL - PERIMATRALES
TRAVETTO REGOLARE - REGULAR JOIST - VIGA REGULAR

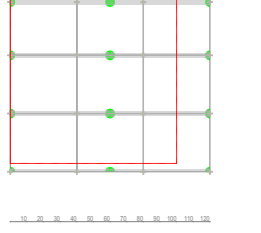

numero basamenti al m2	5,56
ml travetto al m2	3,33
ml profilo silenziatore al m2	6,66
numero elemento fuga al m2	8,33
number of supports per m2	5,56
lm joist per m2	3,33
lm silencer profile per m2	6,66
number of spacer element per m2	8,33
número soportes por m2	5,56
ml viga por m2	3,33
ml perfil de almohadilla por m2	6,66
número elemento junta por m2	8,33

PERIMETRALI - PERIMETRAL - PERIMATRALES
TRAVETTO ORTOGONALE - ORTHOGONAL JOIST - VIGA ORTOGONAL

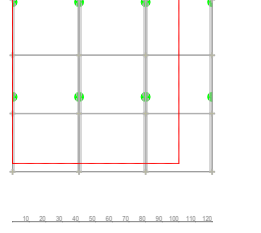

numero basamenti al m2	4,46
ml travetto al m2	2,50
ml profilo silenziatore al m2	5,00
numero elemento fuga al m2	7,44
number of supports per m2	4,46
lm joist per m2	2,50
lm silencer profile per m2	5,00
number of spacer element per m2	7,44
número soportes por m2	4,46
ml viga por m2	2,50
ml perfil de almohadilla por m2	5,00
número elemento junta por m2	7,44

ANGOLARI - ANGULAR - ANGULARES
TRAVETTO REGOLARE - REGULAR JOIST - VIGA REGULAR

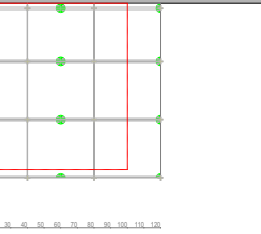

numero basamenti al m2	6,94
ml travetto al m2	3,33
ml profilo silenziatore al m2	6,66
numero elemento fuga al m2	8,93
number of supports per m2	6,94
lm joist per m2	3,33
lm silencer profile per m2	6,66
number of spacer element per m2	8,93
número soportes por m2	6,94
ml viga por m2	3,33
ml perfil de almohadilla por m2	6,66
número elemento junta por m2	8,93

ANGOLARI - ANGULAR - ANGULARES
TRAVETTO ORTOGONALE - ORTHOGONAL JOIST - VIGA ORTOGONAL

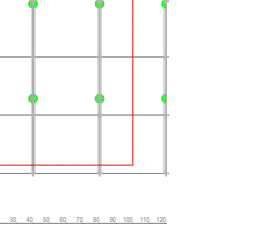

numero basamenti al m2	5,21
ml travetto al m2	2,92
ml profilo silenziatore al m2	5,84
numero elemento fuga al m2	8,48
number of supports per m2	5,21
lm joist per m2	2,92
lm silencer profile per m2	5,84
number of spacer element per m2	8,48
número soportes por m2	5,21
ml viga por m2	2,92
ml perfil de almohadilla por m2	5,84
número elemento junta por m2	8,48

LEGENDA - LEGEND - LEGENDA

- 1 mq
- 1 sq. m
- 1 mc
- Linea perimetrale
- Perimetral line
- Línea perimetral
- Linea d'angolo
- Corner line
- Línea de ángulo
- Basamento
- Support
- Soporte
- Elemento fuga
- Spacer element
- Elemento junta
- Travetto
- Joist
- Viga

I quantitativi possono variare in funzione dell'area da pavimentare.
Quantities can varied based on the geometry of the area to be paved.
Las cantidades pueden variar de acuerdo con la zona que se deba solar.

FORMATO RETTANGOLARE - RECTANGULAR SHAPED - FORMATO RECTANGULAR

30 x 60 cm

CENTRALI - CENTRAL - CENTRALES
TRAVETTO REGOLARE - REGULAR JOIST - VIGA REGULAR

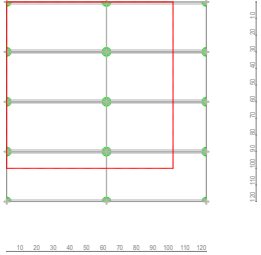

numero basamenti al m2	5,56
ml travetto al m2	3,33
ml profilo silenziatore al m2	6,66
numero elemento fuga al m2	5,56
number of supports per m2	5,56
lm joist per m2	3,33
lm silencer profile per m2	6,66
number of spacer element per m2	5,56
número soportes por m2	5,56
ml viga por m2	3,33
ml perfil de almohadilla por m2	6,66
número elemento junta por m2	5,56

CENTRALI - CENTRAL - CENTRALES
TRAVETTO ORTOGONALE - ORTHOGONAL JOIST - VIGA ORTOGONAL

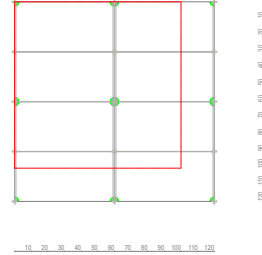

numero basamenti al m2	2,78
ml travetto al m2	1,67
ml profilo silenziatore al m2	3,34
numero elemento fuga al m2	5,56
number of supports per m2	2,78
lm joist per m2	1,67
lm silencer profile per m2	3,34
number of spacer element per m2	5,56
número soportes por m2	2,78 pezzi
ml viga por m2	1,67 ml
ml perfil de almohadilla por m2	3,34 ml
número elemento junta por m2	5,56 pezzi

PERIMETRALI - PERIMETRAL - PERIMATRALES
TRAVETTO REGOLARE - REGULAR JOIST - VIGA REGULAR

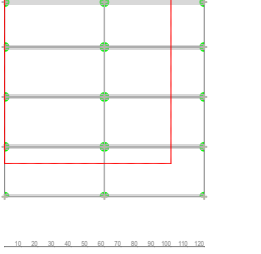

numero basamenti al m2	6,25
ml travetto al m2	3,75
ml profilo silenziatore al m2	7,50
numero elemento fuga al m2	6,25
number of supports per m2	6,25
lm joist per m2	3,75
lm silencer profile per m2	7,50
number of spacer element per m2	6,25
número soportes por m2	6,25
ml viga por m2	3,75
ml perfil de almohadilla por m2	7,50
número elemento junta por m2	6,25

PERIMETRALI - PERIMETRAL - PERIMATRALES
TRAVETTO ORTOGONALE - ORTHOGONAL JOIST - VIGA ORTOGONAL

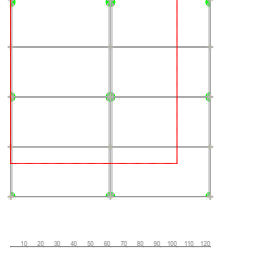

numero basamenti al m2	3,47
ml travetto al m2	1,67
ml profilo silenziatore al m2	3,34
numero elemento fuga al m2	6,25
number of supports per m2	3,47
lm joist per m2	1,67
lm silencer profile per m2	3,34
number of spacer element per m2	6,25
número soportes por m2	3,47
ml viga por m2	1,67
ml perfil de almohadilla por m2	3,34
número elemento junta por m2	6,25

ANGOLARI - ANGULAR - ANGULARES
TRAVETTO REGOLARE - REGULAR JOIST - VIGA REGULAR

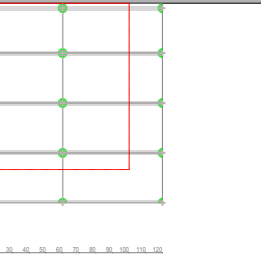

numero basamenti al m2	7,81
ml travetto al m2	3,75
ml profilo silenziatore al m2	7,50
numero elemento fuga al m2	7,12
number of supports per m2	7,81
lm joist per m2	3,75
lm silencer profile per m2	7,50
number of spacer element per m2	7,12
número soportes por m2	7,81
ml viga por m2	3,75
ml perfil de almohadilla por m2	7,50
número elemento junta por m2	7,12

ANGOLARI - ANGULAR - ANGULARES
TRAVETTO ORTOGONALE - ORTHOGONAL JOIST - VIGA ORTOGONAL

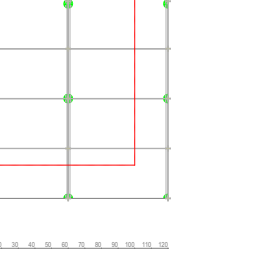

numero basamenti al m2	4,34
ml travetto al m2	2,08
ml profilo silenziatore al m2	4,16
numero elemento fuga al m2	7,12
number of supports per m2	4,34
lm joist per m2	2,08
lm silencer profile per m2	4,16
number of spacer element per m2	7,12
número soportes por m2	4,34
ml viga por m2	2,08
ml perfil de almohadilla por m2	4,16
número elemento junta por m2	7,12

LEGENDA - LEGEND - LEGENDA

 1 mq 1 sq. m 1 mc	 Linea perimetrale Perimetral line Línea perimetral	 Linea d'angolo Corner line Línea de ángulo	 Basamento Support Soporte	 Elemento fuga Spacer element Elemento junta	 Travetto Joist Viga
---	--	--	---	---	---

I quantitativi possono variare in funzione dell'area da pavimentare.
 Quantities can varied based on the geometry of the area to be paved.
 Las cantidades pueden variar de acuerdo con la zona que se deba solar.

FORMATO RETTANGOLARE - RECTANGULAR SHAPED - FORMATO RECTANGULAR

40 x 60 cm

CENTRALI - CENTRAL - CENTRALES
TRAVETTO REGOLARE - REGULAR JOIST - VIGA REGULAR

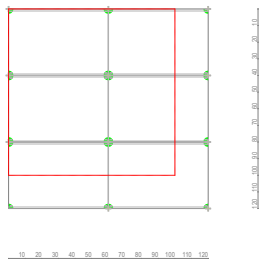

numero basamenti al m2	4,17
ml travetto al m2	2,50
ml profilo silenziatore al m2	5,00
numero elemento fuga al m2	4,17
number of supports per m2	4,17
lm joist per m2	2,50
lm silencer profile per m2	5,00
number of spacer element per m2	4,17
número soportes por m2	4,17
ml viga por m2	2,50
ml perfil de almohadilla por m2	5,00
número elemento junta por m2	4,17

CENTRALI - CENTRAL - CENTRALES
TRAVETTO ORTOGONALE - ORTHOGONAL JOIST - VIGA ORTOGONAL

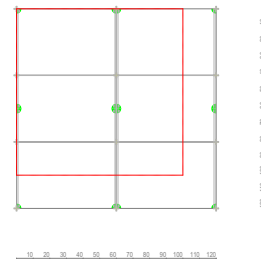

numero basamenti al m2	2,78
ml travetto al m2	1,67
ml profilo silenziatore al m2	3,34
numero elemento fuga al m2	4,17
number of supports per m2	2,78
lm joist per m2	1,67
lm silencer profile per m2	3,34
number of spacer element per m2	4,17
número soportes por m2	2,78
ml viga por m2	1,67
ml perfil de almohadilla por m2	3,34
número elemento junta por m2	4,17

PERIMETRALI - PERIMETRAL - PERIMATRALES
TRAVETTO REGOLARE - REGULAR JOIST - VIGA REGULAR

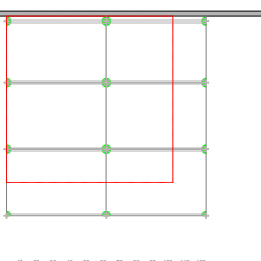

numero basamenti al m2	4,86
ml travetto al m2	2,92
ml profilo silenziatore al m2	5,84
numero elemento fuga al m2	4,86
number of supports per m2	4,86
lm joist per m2	2,92
lm silencer profile per m2	5,84
number of spacer element per m2	4,86
número soportes por m2	4,86
ml viga por m2	2,92
ml perfil de almohadilla por m2	5,84
número elemento junta por m2	4,86

PERIMETRALI - PERIMETRAL - PERIMATRALES
TRAVETTO ORTOGONALE - ORTHOGONAL JOIST - VIGA ORTOGONAL

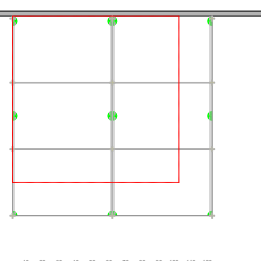

numero basamenti al m2	3,47
ml travetto al m2	1,67
ml profilo silenziatore al m2	3,34
numero elemento fuga al m2	4,86
number of supports per m2	3,47
lm joist per m2	1,67
lm silencer profile per m2	3,34
number of spacer element per m2	4,86
número soportes por m2	3,47
ml viga por m2	1,67
ml perfil de almohadilla por m2	3,34
número elemento junta por m2	4,86

ANGOLARI - ANGULAR - ANGULARES
TRAVETTO REGOLARE - REGULAR JOIST - VIGA REGULAR

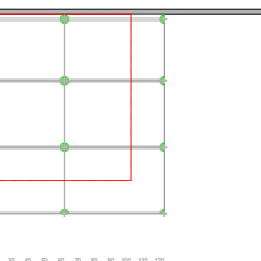

numero basamenti al m2	6,08
ml travetto al m2	2,92
ml profilo silenziatore al m2	5,84
numero elemento fuga al m2	5,38
number of supports per m2	6,08
lm joist per m2	2,92
lm silencer profile per m2	5,84
number of spacer element per m2	5,38
número soportes por m2	6,08
ml viga por m2	2,92
ml perfil de almohadilla por m2	5,84
número elemento junta por m2	5,38

ANGOLARI - ANGULAR - ANGULARES
TRAVETTO ORTOGONALE - ORTHOGONAL JOIST - VIGA ORTOGONAL

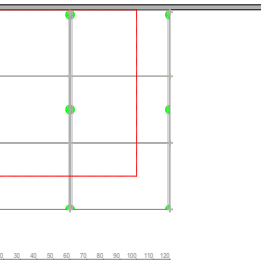

numero basamenti al m2	4,34
ml travetto al m2	2,08
ml profilo silenziatore al m2	4,16
numero elemento fuga al m2	5,38
number of supports per m2	4,34
lm joist per m2	2,08
lm silencer profile per m2	4,16
number of spacer element per m2	5,38
número soportes por m2	4,34
ml viga por m2	2,08
ml perfil de almohadilla por m2	4,16
número elemento junta por m2	5,38

LEGENDA - LEGEND - LEGENDA

- 1 mq
- 1 sq. m
- 1 mc
- Linea perimetrale
- Perimetral line
- Línea perimetral
- Linea d'angolo
- Corner line
- Línea de ángulo
- Basamento
- Support
- Soporte
- Elemento fuga
- Spacer element
- Elemento junta
- Travetto
- Joist
- Viga

I quantitativi possono variare in funzione dell'area da pavimentare.
 Quantities can varied based on the geometry of the area to be paved.
 Las cantidades pueden variar de acuerdo con la zona que se deba solar.

FORMATO RETTANGOLARE - RECTANGULAR SHAPED - FORMATO RECTANGULAR

40 x 80 cm

CENTRALI - CENTRAL - CENTRALES
TRAVETTO REGOLARE - REGULAR JOIST - VIGA REGULAR

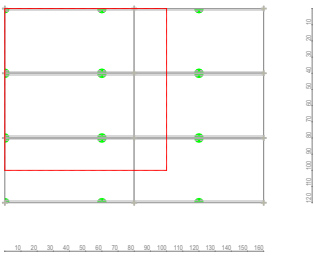

numero basamenti al m2	4,17
ml travetto al m2	2,50
ml profilo silenziatore al m2	5,00
numero elemento fuga al m2	3,13
number of supports per m2	4,17
lm joist per m2	2,50
lm silencer profile per m2	5,00
number of spacer element per m2	3,13
número soportes por m2	4,17
ml viga por m2	2,50
ml perfil de almohadilla por m2	5,00
número elemento junta por m2	3,13

CENTRALI - CENTRAL - CENTRALES
TRAVETTO ORTOGONALE - ORTHOGONAL JOIST - VIGA ORTOGONAL

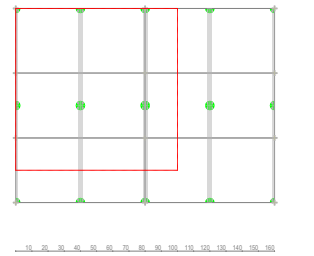

numero basamenti al m2	4,17
ml travetto al m2	2,50
ml profilo silenziatore al m2	5,00
numero elemento fuga al m2	3,13
number of supports per m2	4,17
lm joist per m2	2,50
lm silencer profile per m2	5,00
number of spacer element per m2	3,13
número soportes por m2	4,17
ml viga por m2	2,50
ml perfil de almohadilla por m2	5,00
número elemento junta por m2	3,13

PERIMETRALI - PERIMETRAL - PERIMATRALES
TRAVETTO REGOLARE - REGULAR JOIST - VIGA REGULAR

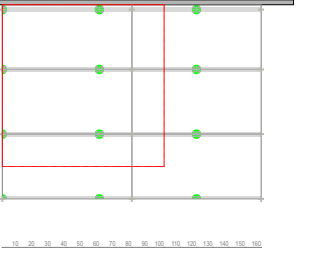

numero basamenti al m2	4,86
ml travetto al m2	2,92
ml profilo silenziatore al m2	5,84
numero elemento fuga al m2	3,65
number of supports per m2	4,86
lm joist per m2	2,92
lm silencer profile per m2	5,84
number of spacer element per m2	3,65
número soportes por m2	4,86
ml viga por m2	2,92
ml perfil de almohadilla por m2	5,84
número elemento junta por m2	3,65

PERIMETRALI - PERIMETRAL - PERIMATRALES
TRAVETTO ORTOGONALE - ORTHOGONAL JOIST - VIGA ORTOGONAL

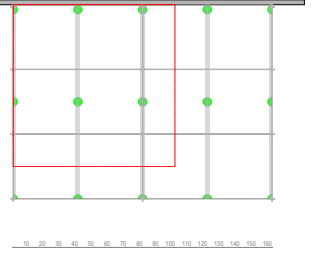

numero basamenti al m2	5,21
ml travetto al m2	2,50
ml profilo silenziatore al m2	5,00
numero elemento fuga al m2	3,65
number of supports per m2	5,21
lm joist per m2	2,50
lm silencer profile per m2	5,00
number of spacer element per m2	3,65
número soportes por m2	5,21
ml viga por m2	2,50
ml perfil de almohadilla por m2	5,00
número elemento junta por m2	3,65

ANGOLARI - ANGULAR - ANGULARES
TRAVETTO REGOLARE - REGULAR JOIST - VIGA REGULAR

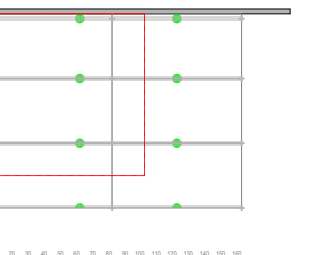

numero basamenti al m2	5,47
ml travetto al m2	2,92
ml profilo silenziatore al m2	5,84
numero elemento fuga al m2	3,91
number of supports per m2	5,47
lm joist per m2	2,92
lm silencer profile per m2	5,84
number of spacer element per m2	3,91
número soportes por m2	5,47
ml viga por m2	2,92
ml perfil de almohadilla por m2	5,84
número elemento junta por m2	3,91

ANGOLARI - ANGULAR - ANGULARES
TRAVETTO ORTOGONALE - ORTHOGONAL JOIST - VIGA ORTOGONAL

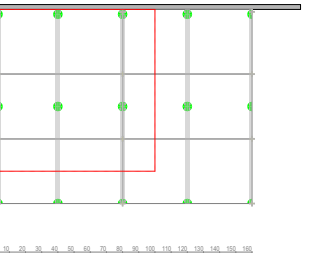

numero basamenti al m2	5,86
ml travetto al m2	2,81
ml profilo silenziatore al m2	5,62
numero elemento fuga al m2	4,04
number of supports per m2	5,86
lm joist per m2	2,81
lm silencer profile per m2	5,62
number of spacer element per m2	4,04
número soportes por m2	5,86
ml viga por m2	2,81
ml perfil de almohadilla por m2	5,62
número elemento junta por m2	4,04

LEGENDA - LEGEND - LEGENDA

 1 mq 1 sq. m 1 mc	 Linea perimetrale Perimetral line Línea perimetral	 Linea d'angolo Corner line Línea de ángulo	 Basamento Support Soporte	 Elemento fuga Spacer element Elemento junta	 Travetto Joist Viga
---	--	--	---	---	---

I quantitativi possono variare in funzione dell'area da pavimentare.
 Quantities can varied based on the geometry of the area to be paved.
 Las cantidades pueden variar de acuerdo con la zona que se deba solar.

FORMATO RETTANGOLARE - RECTANGULAR SHAPED - FORMATO RECTANGULAR

30 x 90 cm

CENTRALI - CENTRAL - CENTRALES
TRAVETTO REGOLARE - REGULAR JOIST - VIGA REGULAR

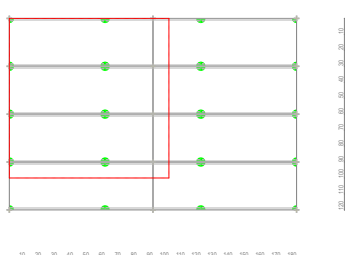

numero basamenti al m2	5,56
ml travetto al m2	3,33
ml profilo silenziatore al m2	6,66
numero elemento fuga al m2	3,70
number of supports per m2	5,56
lm joist per m2	3,33
lm silencer profile per m2	6,66
number of spacer element per m2	3,70
número soportes por m2	5,56
ml viga por m2	3,33
ml perfil de almohadilla por m2	6,66
número elemento junta por m2	3,70

CENTRALI - CENTRAL - CENTRALES
TRAVETTO ORTOGONALE - ORTHOGONAL JOIST - VIGA ORTOGONAL

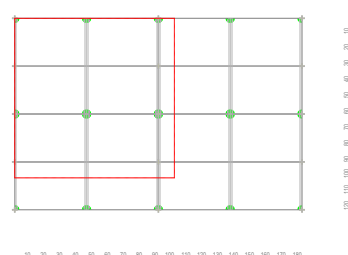

numero basamenti al m2	3,70
ml travetto al m2	2,22
ml profilo silenziatore al m2	4,44
numero elemento fuga al m2	3,70
number of supports per m2	3,70
lm joist per m2	2,22
lm silencer profile per m2	4,44
number of spacer element per m2	3,70
número soportes por m2	3,70
ml viga por m2	2,22
ml perfil de almohadilla por m2	4,44
número elemento junta por m2	3,70

PERIMETRALI - PERIMETRAL - PERIMATRALES
TRAVETTO REGOLARE - REGULAR JOIST - VIGA REGULAR

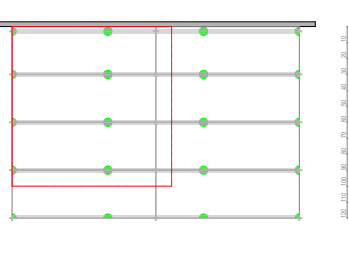

numero basamenti al m2	6,25
ml travetto al m2	3,75
ml profilo silenziatore al m2	7,50
numero elemento fuga al m2	4,17
number of supports per m2	6,25
lm joist per m2	3,75
lm silencer profile per m2	7,50
number of spacer element per m2	4,17
número soportes por m2	6,25
ml viga por m2	3,75
ml perfil de almohadilla por m2	7,50
número elemento junta por m2	4,17

PERIMETRALI - PERIMETRAL - PERIMATRALES
TRAVETTO ORTOGONALE - ORTHOGONAL JOIST - VIGA ORTOGONAL

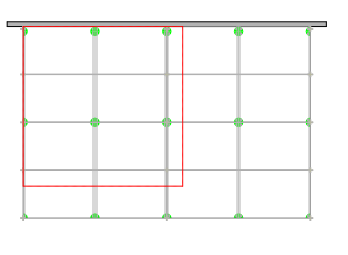

numero basamenti al m2	4,63
ml travetto al m2	2,22
ml profilo silenziatore al m2	4,44
numero elemento fuga al m2	4,17
number of supports per m2	4,63
lm joist per m2	2,22
lm silencer profile per m2	4,44
number of spacer element per m2	4,17
número soportes por m2	4,63
ml viga por m2	2,22
ml perfil de almohadilla por m2	4,44
número elemento junta por m2	4,17

ANGOLARI - ANGULAR - ANGULARES
TRAVETTO REGOLARE - REGULAR JOIST - VIGA REGULAR

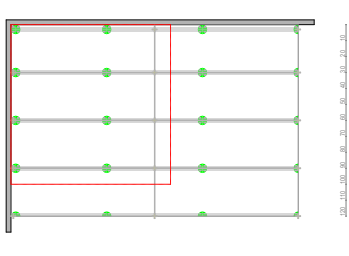

numero basamenti al m2	7,29
ml travetto al m2	3,75
ml profilo silenziatore al m2	7,50
numero elemento fuga al m2	4,75
number of supports per m2	7,29
lm joist per m2	3,75
lm silencer profile per m2	7,50
number of spacer element per m2	4,75
número soportes por m2	7,29
ml viga por m2	3,75
ml perfil de almohadilla por m2	7,50
número elemento junta por m2	4,75

ANGOLARI - ANGULAR - ANGULARES
TRAVETTO ORTOGONALE - ORTHOGONAL JOIST - VIGA ORTOGONAL

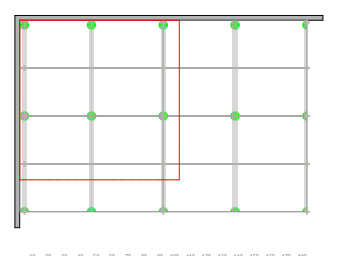

numero basamenti al m2	5,21
ml travetto al m2	2,50
ml profilo silenziatore al m2	5,00
numero elemento fuga al m2	4,75
number of supports per m2	5,21
lm joist per m2	2,50
lm silencer profile per m2	5,00
number of spacer element per m2	4,75
número soportes por m2	5,21
ml viga por m2	2,50
ml perfil de almohadilla por m2	5,00
número elemento junta por m2	4,75

LEGENDA - LEGEND - LEGENDA

- 1 mq
1 sq. m
1 mc
- Linea perimetrale
Perimetral line
Línea perimetral
- Linea d'angolo
Corner line
Línea de ángulo
- Basamento
Support
Soporte
- Elemento fuga
Spacer element
Elemento junta
- Travetto
Joist
Viga

I quantitativi possono variare in funzione dell'area da pavimentare.
 Quantities can varied based on the geometry of the area to be paved.
 Las cantidades pueden variar de acuerdo con la zona que se deba solar.

FORMATO RETTANGOLARE - RECTANGULAR SHAPED - FORMATO RECTANGULAR

40 x 90 cm

CENTRALI - CENTRAL - CENTRALES
TRAVETTO REGOLARE - REGULAR JOIST - VIGA REGULAR

numero basamenti al m2	4,17
ml travetto al m2	2,50
ml profilo silenziatore al m2	5,00
numero elemento fuga al m2	2,78
number of supports per m2	4,17
lm joist per m2	2,50
lm silencer profile per m2	5,00
number of spacer element per m2	2,78
número soportes por m2	4,17
ml viga por m2	2,50
ml perfil de almohadilla por m2	5,00
número elemento junta por m2	2,78

CENTRALI - CENTRAL - CENTRALES
TRAVETTO ORTOGONALE - ORTHOGONAL JOIST - VIGA ORTOGONAL

numero basamenti al m2	3,70
ml travetto al m2	2,22
ml profilo silenziatore al m2	4,44
numero elemento fuga al m2	2,78
number of supports per m2	3,70
lm joist per m2	2,22
lm silencer profile per m2	4,44
number of spacer element per m2	2,78
número soportes por m2	3,70
ml viga por m2	2,22
ml perfil de almohadilla por m2	4,44
número elemento junta por m2	2,78

PERIMETRALI - PERIMETRAL - PERIMATRALES
TRAVETTO REGOLARE - REGULAR JOIST - VIGA REGULAR

numero basamenti al m2	4,86
ml travetto al m2	2,92
ml profilo silenziatore al m2	5,84
numero elemento fuga al m2	3,24
number of supports per m2	4,86
lm joist per m2	2,92
lm silencer profile per m2	5,84
number of spacer element per m2	3,24
número soportes por m2	4,86
ml viga por m2	2,92
ml perfil de almohadilla por m2	5,84
número elemento junta por m2	3,24

PERIMETRALI - PERIMETRAL - PERIMATRALES
TRAVETTO ORTOGONALE - ORTHOGONAL JOIST - VIGA ORTOGONAL

numero basamenti al m2	4,63
ml travetto al m2	2,22
ml profilo silenziatore al m2	4,44
numero elemento fuga al m2	3,24
number of supports per m2	4,63
lm joist per m2	2,22
lm silencer profile per m2	4,44
number of spacer element per m2	3,24
número soportes por m2	4,63
ml viga por m2	2,22
ml perfil de almohadilla por m2	4,44
número elemento junta por m2	3,24

ANGOLARI - ANGULAR - ANGULARES
TRAVETTO REGOLARE - REGULAR JOIST - VIGA REGULAR

numero basamenti al m2	5,67
ml travetto al m2	2,92
ml profilo silenziatore al m2	5,84
numero elemento fuga al m2	3,59
number of supports per m2	5,67
lm joist per m2	2,92
lm silencer profile per m2	5,84
number of spacer element per m2	3,59
número soportes por m2	5,67
ml viga por m2	2,92
ml perfil de almohadilla por m2	5,84
número elemento junta por m2	3,59

ANGOLARI - ANGULAR - ANGULARES
TRAVETTO ORTOGONALE - ORTHOGONAL JOIST - VIGA ORTOGONAL

numero basamenti al m2	5,21
ml travetto al m2	2,50
ml profilo silenziatore al m2	5,00
numero elemento fuga al m2	3,59
number of supports per m2	5,21
lm joist per m2	2,50
lm silencer profile per m2	5,00
number of spacer element per m2	3,59
número soportes por m2	5,21
ml viga por m2	2,50
ml perfil de almohadilla por m2	5,00
número elemento junta por m2	3,59

LEGENDA - LEGEND - LEGENDA

1 mq 1 sq. m 1 mc	Linea perimetrale Perimetral line Línea perimetral	Linea d'angolo Corner line Línea de ángulo	Basamento Support Soporte	Elemento fuga Spacer element Elemento junta	Travetto Joist Viga
-------------------------	--	--	---------------------------------	---	---------------------------

I quantitativi possono variare in funzione dell'area da pavimentare.
 Quantities can varied based on the geometry of the area to be paved.
 Las cantidades pueden variar de acuerdo con la zona que se deba solar.

FORMATO RETTANGOLARE - RECTANGULAR SHAPED - FORMATO RECTANGULAR

45 x 90 cm

CENTRALI - CENTRAL - CENTRALES
TRAVETTO REGOLARE - REGULAR JOIST - VIGA REGULAR

numero basamenti al m2	3,70
ml travetto al m2	2,22
ml profilo silenziatore al m2	4,44
numero elemento fuga al m2	2,47
number of supports per m2	3,70
lm joist per m2	2,22
lm silencer profile per m2	4,44
number of spacer element per m2	2,47
número soportes por m2	3,70
ml viga por m2	2,22
ml perfil de almohadilla por m2	4,44
número elemento junta por m2	2,47

CENTRALI - CENTRAL - CENTRALES
TRAVETTO ORTOGONALE - ORTHOGONAL JOIST - VIGA ORTOGONAL

numero basamenti al m2	3,70
ml travetto al m2	2,22
ml profilo silenziatore al m2	4,44
numero elemento fuga al m2	2,47
number of supports per m2	3,70
lm joist per m2	2,22
lm silencer profile per m2	4,44
number of spacer element per m2	2,47
número soportes por m2	3,70
ml viga por m2	2,22
ml perfil de almohadilla por m2	4,44
número elemento junta por m2	2,47

PERIMETRALI - PERIMETRAL - PERIMATRALES
TRAVETTO REGOLARE - REGULAR JOIST - VIGA REGULAR

numero basamenti al m2	4,32
ml travetto al m2	2,59
ml profilo silenziatore al m2	5,18
numero elemento fuga al m2	2,88
number of supports per m2	4,32
lm joist per m2	2,59
lm silencer profile per m2	5,18
number of spacer element per m2	2,88
número soportes por m2	4,32
ml viga por m2	2,59
ml perfil de almohadilla por m2	5,18
número elemento junta por m2	2,88

PERIMETRALI - PERIMETRAL - PERIMATRALES
TRAVETTO ORTOGONALE - ORTHOGONAL JOIST - VIGA ORTOGONAL

numero basamenti al m2	4,32
ml travetto al m2	2,22
ml profilo silenziatore al m2	4,44
numero elemento fuga al m2	2,78
number of supports per m2	4,32
lm joist per m2	2,22
lm silencer profile per m2	4,44
number of spacer element per m2	2,78
número soportes por m2	4,32
ml viga por m2	2,22
ml perfil de almohadilla por m2	4,44
número elemento junta por m2	2,78

ANGOLARI - ANGULAR - ANGULARES
TRAVETTO REGOLARE - REGULAR JOIST - VIGA REGULAR

numero basamenti al m2	5,04
ml travetto al m2	2,59
ml profilo silenziatore al m2	5,18
numero elemento fuga al m2	3,19
number of supports per m2	5,04
lm joist per m2	2,59
lm silencer profile per m2	5,18
number of spacer element per m2	3,19
número soportes por m2	5,04
ml viga por m2	2,59
ml perfil de almohadilla por m2	5,18
número elemento junta por m2	3,19

ANGOLARI - ANGULAR - ANGULARES
TRAVETTO ORTOGONALE - ORTHOGONAL JOIST - VIGA ORTOGONAL

numero basamenti al m2	4,86
ml travetto al m2	2,50
ml profilo silenziatore al m2	5,00
numero elemento fuga al m2	3,16
number of supports per m2	4,86
lm joist per m2	2,50
lm silencer profile per m2	5,00
number of spacer element per m2	3,16
número soportes por m2	4,86
ml viga por m2	2,50
ml perfil de almohadilla por m2	5,00
número elemento junta por m2	3,16

LEGENDA - LEGEND - LEGENDA

1 mq 1 sq. m 1 mc	Linea perimetrale Perimetral line Línea perimetral	Linea d'angolo Corner line Línea de ángulo	Basamento Support Soporte	Elemento fuga Spacer element Elemento junta	Travetto Joist Viga
-------------------------	--	--	---------------------------------	---	---------------------------

I quantitativi possono variare in funzione dell'area da pavimentare.
 Quantities can varied based on the geometry of the area to be paved.
 Las cantidades pueden variar de acuerdo con la zona que se deba solar.

FORMATO RETTANGOLARE - RECTANGULAR SHAPED - FORMATO RECTANGULAR

60 x 90 cm

CENTRALI - CENTRAL - CENTRALES
TRAVETTO REGOLARE - REGULAR JOIST - VIGA REGULAR

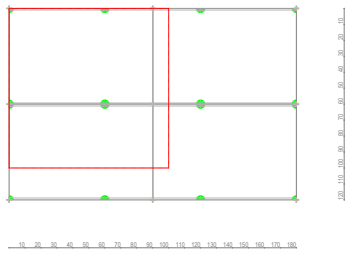

numero basamenti al m2	2,78
ml travetto al m2	1,67
ml profilo silenziatore al m2	3,34
numero elemento fuga al m2	1,85
number of supports per m2	2,78
lm joist per m2	1,67
lm silencer profile per m2	3,34
number of spacer element per m2	1,85
número soportes por m2	2,78
ml viga por m2	1,67
ml perfil de almohadilla por m2	3,34
número elemento junta por m2	1,85

CENTRALI - CENTRAL - CENTRALES
TRAVETTO ORTOGONALE - ORTHOGONAL JOIST - VIGA ORTOGONAL

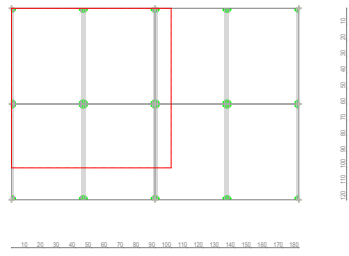

numero basamenti al m2	3,70
ml travetto al m2	2,22
ml profilo silenziatore al m2	4,44
numero elemento fuga al m2	1,85
number of supports per m2	3,70
lm joist per m2	2,22
lm silencer profile per m2	4,44
number of spacer element per m2	1,85
número soportes por m2	3,70
ml viga por m2	2,22
ml perfil de almohadilla por m2	4,44
número elemento junta por m2	1,85

PERIMETRALI - PERIMETRAL - PERIMATRALES
TRAVETTO REGOLARE - REGULAR JOIST - VIGA REGULAR

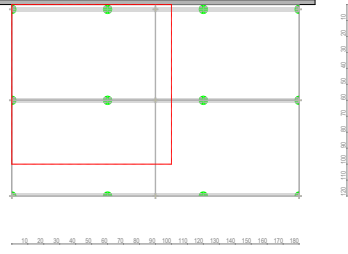

numero basamenti al m2	3,47
ml travetto al m2	2,08
ml profilo silenziatore al m2	4,16
numero elemento fuga al m2	2,31
number of supports per m2	3,47
lm joist per m2	2,08
lm silencer profile per m2	4,16
number of spacer element per m2	2,31
número soportes por m2	3,47
ml viga por m2	2,08
ml perfil de almohadilla por m2	4,16
número elemento junta por m2	2,31

PERIMETRALI - PERIMETRAL - PERIMATRALES
TRAVETTO ORTOGONALE - ORTHOGONAL JOIST - VIGA ORTOGONAL

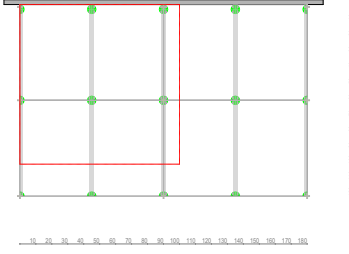

numero basamenti al m2	4,63
ml travetto al m2	2,22
ml profilo silenziatore al m2	4,44
numero elemento fuga al m2	2,31
number of supports per m2	4,63
lm joist per m2	2,22
lm silencer profile per m2	4,44
number of spacer element per m2	2,31
número soportes por m2	4,63
ml viga por m2	2,22
ml perfil de almohadilla por m2	4,44
número elemento junta por m2	2,31

ANGOLARI - ANGULAR - ANGULARES
TRAVETTO REGOLARE - REGULAR JOIST - VIGA REGULAR

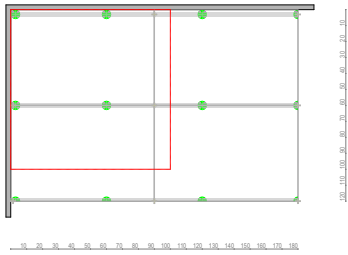

numero basamenti al m2	4,05
ml travetto al m2	2,08
ml profilo silenziatore al m2	4,16
numero elemento fuga al m2	2,43
number of supports per m2	4,05
lm joist per m2	2,08
lm silencer profile per m2	4,16
number of spacer element per m2	2,43
número soportes por m2	4,05
ml viga por m2	2,08
ml perfil de almohadilla por m2	4,16
número elemento junta por m2	2,43

ANGOLARI - ANGULAR - ANGULARES
TRAVETTO ORTOGONALE - ORTHOGONAL JOIST - VIGA ORTOGONAL

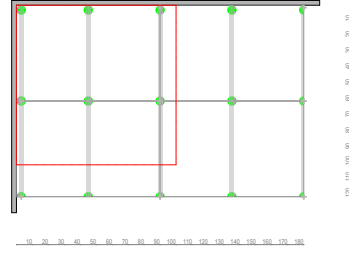

numero basamenti al m2	5,21
ml travetto al m2	2,50
ml profilo silenziatore al m2	5,00
numero elemento fuga al m2	2,43
number of supports per m2	5,21
lm joist per m2	2,50
lm silencer profile per m2	5,00
number of spacer element per m2	2,43
número soportes por m2	5,21
ml viga por m2	2,50
ml perfil de almohadilla por m2	5,00
número elemento junta por m2	2,43

LEGENDA - LEGEND - LEGENDA

 1 mq	 Linea perimetrale	 Linea d'angolo	 Basamento	 Elemento fuga	 Travetto
 1 sq. m	 Perimetral line	 Corner line	 Soporte	 Spacer element	 Joist
 1 mc	 Línea perimetral	 Línea de ángulo		 Elemento junta	 Viga

I quantitativi possono variare in funzione dell'area da pavimentare.
Quantities can varied based on the geometry of the area to be paved.
Las cantidades pueden variar de acuerdo con la zona que se deba solar.

FORMATO RETTANGOLARE - RECTANGULAR SHAPED - FORMATO RECTANGULAR

20 x 120 cm

CENTRALI - CENTRAL - CENTRALES
TRAVETTO REGOLARE - REGULAR JOIST - VIGA REGULAR

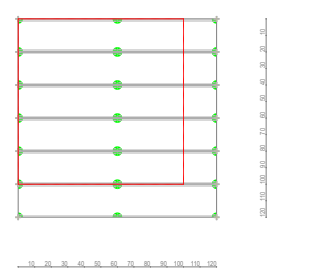

numero basamenti al m2	8,33
ml travetto al m2	5,00
ml profilo silenziatore al m2	10,00
numero elemento fuga al m2	4,17
number of supports per m2	8,33
lm joist per m2	5,00
lm silencer profile per m2	10,00
number of spacer element per m2	4,17
número soportes por m2	8,33
ml viga por m2	5,00
ml perfil de almohadilla por m2	10,00
número elemento junta por m2	4,17

CENTRALI - CENTRAL - CENTRALES
TRAVETTO ORTOGONALE - ORTHOGONAL JOIST - VIGA ORTOGONAL

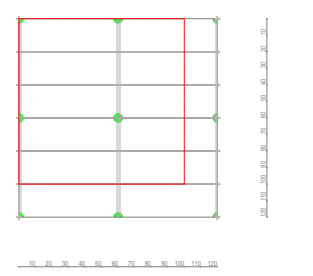

numero basamenti al m2	2,78
ml travetto al m2	1,67
ml profilo silenziatore al m2	3,34
numero elemento fuga al m2	4,17
number of supports per m2	2,78
lm joist per m2	1,67
lm silencer profile per m2	3,34
number of spacer element per m2	4,17
número soportes por m2	2,78
ml viga por m2	1,67
ml perfil de almohadilla por m2	3,34
número elemento junta por m2	4,17

PERIMETRALI - PERIMETRAL - PERIMATRALES
TRAVETTO REGOLARE - REGULAR JOIST - VIGA REGULAR

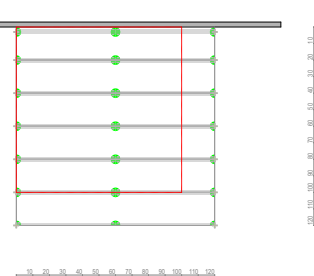

numero basamenti al m2	9,13
ml travetto al m2	5,42
ml profilo silenziatore al m2	10,84
numero elemento fuga al m2	4,51
number of supports per m2	9,13
lm joist per m2	5,42
lm silencer profile per m2	10,84
number of spacer element per m2	4,51
número soportes por m2	9,13
ml viga por m2	5,42
ml perfil de almohadilla por m2	10,84
número elemento junta por m2	4,51

PERIMETRALI - PERIMETRAL - PERIMATRALES
TRAVETTO ORTOGONALE - ORTHOGONAL JOIST - VIGA ORTOGONAL

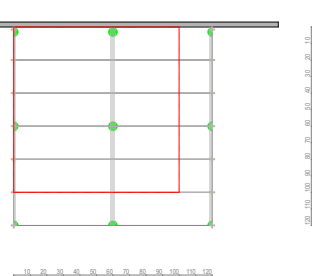

numero basamenti al m2	3,47
ml travetto al m2	1,67
ml profilo silenziatore al m2	3,34
numero elemento fuga al m2	4,51
number of supports per m2	3,47
lm joist per m2	1,67
lm silencer profile per m2	3,34
number of spacer element per m2	4,51
número soportes por m2	3,47
ml viga por m2	1,67
ml perfil de almohadilla por m2	3,34
número elemento junta por m2	4,51

ANGOLARI - ANGULAR - ANGULARES
TRAVETTO REGOLARE - REGULAR JOIST - VIGA REGULAR

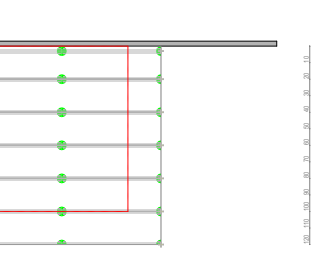

numero basamenti al m2	11,28
ml travetto al m2	5,42
ml profilo silenziatore al m2	10,84
numero elemento fuga al m2	6,08
number of supports per m2	11,28
lm joist per m2	5,42
lm silencer profile per m2	10,84
number of spacer element per m2	6,08
número soportes por m2	11,28
ml viga por m2	5,42
ml perfil de almohadilla por m2	10,84
número elemento junta por m2	6,08

ANGOLARI - ANGULAR - ANGULARES
TRAVETTO ORTOGONALE - ORTHOGONAL JOIST - VIGA ORTOGONAL

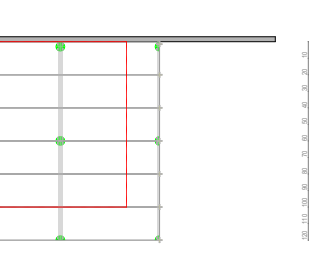

numero basamenti al m2	4,34
ml travetto al m2	2,08
ml profilo silenziatore al m2	4,16
numero elemento fuga al m2	6,08
number of supports per m2	4,34
lm joist per m2	2,08
lm silencer profile per m2	4,16
number of spacer element per m2	6,08
número soportes por m2	4,34
ml viga por m2	2,08
ml perfil de almohadilla por m2	4,16
número elemento junta por m2	6,08

LEGENDA - LEGEND - LEGENDA

- 1 mq
- 1 sq. m
- 1 mc
- Linea perimetrale
- Perimetral line
- Línea perimetral
- Linea d'angolo
- Corner line
- Línea de ángulo
- Basamento
- Support
- Soporte
- Elemento fuga
- Spacer element
- Elemento junta
- Travetto
- Joist
- Viga

I quantitativi possono variare in funzione dell'area da pavimentare.
 Quantities can varied based on the geometry of the area to be paved.
 Las cantidades pueden variar de acuerdo con la zona que se deba solar.

FORMATO RETTANGOLARE - RECTANGULAR SHAPED - FORMATO RECTANGULAR

30 x 120 cm

CENTRALI - CENTRAL - CENTRALES
TRAVETTO REGOLARE - REGULAR JOIST - VIGA REGULAR

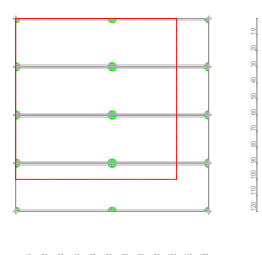

numero basamenti al m2	5,56
ml travetto al m2	3,33
ml profilo silenziatore al m2	6,66
numero elemento fuga al m2	2,78
number of supports per m2	5,56
lm joist per m2	3,33
lm silencer profile per m2	6,66
number of spacer element per m2	2,78
número soportes por m2	5,56
ml viga por m2	3,33
ml perfil de almohadilla por m2	6,66
número elemento junta por m2	2,78

CENTRALI - CENTRAL - CENTRALES
TRAVETTO ORTOGONALE - ORTHOGONAL JOIST - VIGA ORTOGONAL

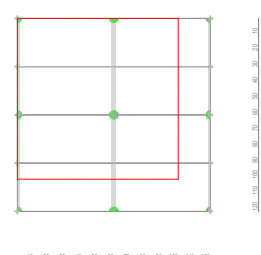

numero basamenti al m2	2,78
ml travetto al m2	1,67
ml profilo silenziatore al m2	3,34
numero elemento fuga al m2	2,78
number of supports per m2	2,78
lm joist per m2	1,67
lm silencer profile per m2	3,34
number of spacer element per m2	2,78
número soportes por m2	2,78
ml viga por m2	1,67
ml perfil de almohadilla por m2	3,34
número elemento junta por m2	2,78

PERIMETRALI - PERIMETRAL - PERIMATRALES
TRAVETTO REGOLARE - REGULAR JOIST - VIGA REGULAR

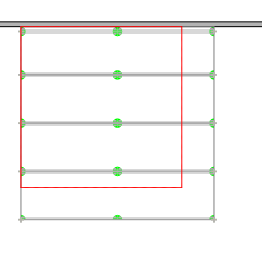

numero basamenti al m2	6,25
ml travetto al m2	3,75
ml profilo silenziatore al m2	7,50
numero elemento fuga al m2	3,13
number of supports per m2	6,25
lm joist per m2	3,75
lm silencer profile per m2	7,50
number of spacer element per m2	3,13
número soportes por m2	6,25
ml viga por m2	3,75
ml perfil de almohadilla por m2	7,50
número elemento junta por m2	3,13

PERIMETRALI - PERIMETRAL - PERIMATRALES
TRAVETTO ORTOGONALE - ORTHOGONAL JOIST - VIGA ORTOGONAL

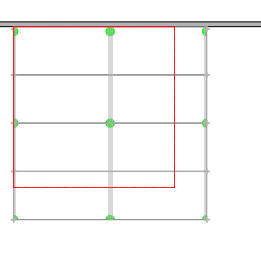

numero basamenti al m2	3,47
ml travetto al m2	1,67
ml profilo silenziatore al m2	3,34
numero elemento fuga al m2	3,13
number of supports per m2	3,47
lm joist per m2	1,67
lm silencer profile per m2	3,34
number of spacer element per m2	3,13
número soportes por m2	3,47
ml viga por m2	1,67
ml perfil de almohadilla por m2	3,34
número elemento junta por m2	3,13

ANGOLARI - ANGULAR - ANGULARES
TRAVETTO REGOLARE - REGULAR JOIST - VIGA REGULAR

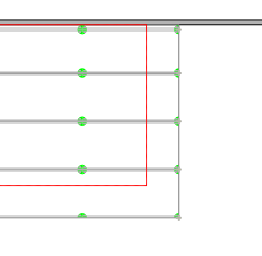

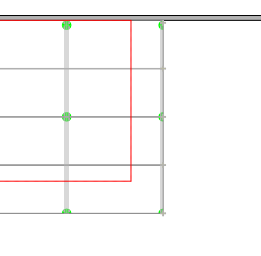

numero basamenti al m2	7,81
ml travetto al m2	3,75
ml profilo silenziatore al m2	7,50
numero elemento fuga al m2	3,99
number of supports per m2	7,81
lm joist per m2	3,75
lm silencer profile per m2	7,50
number of spacer element per m2	3,99
número soportes por m2	7,81
ml viga por m2	3,75
ml perfil de almohadilla por m2	7,50
número elemento junta por m2	3,99

ANGOLARI - ANGULAR - ANGULARES
TRAVETTO ORTOGONALE - ORTHOGONAL JOIST - VIGA ORTOGONAL



numero basamenti al m2	4,34
ml travetto al m2	2,08
ml profilo silenziatore al m2	4,16
numero elemento fuga al m2	3,99
number of supports per m2	4,34
lm joist per m2	2,08
lm silencer profile per m2	4,16
number of spacer element per m2	3,99
número soportes por m2	4,34
ml viga por m2	2,08
ml perfil de almohadilla por m2	4,16
número elemento junta por m2	3,99

LEGENDA - LEGEND - LEGENDA

 1 mq 1 sq. m 1 mc	 Linea perimetrale Perimetral line Línea perimetral	 Linea d'angolo Corner line Línea de ángulo	 Basamento Support Soporte	 Elemento fuga Spacer element Elemento junta	 Travetto Joist Viga
---	--	--	---	---	---

I quantitativi possono variare in funzione dell'area da pavimentare.
Quantities can varied based on the geometry of the area to be paved.
Las cantidades pueden variar de acuerdo con la zona que se deba solar.

FORMATO RETTANGOLARE - RECTANGULAR SHAPED - FORMATO RECTANGULAR

40 x 120 cm

CENTRALI - CENTRAL - CENTRALES
TRAVETTO REGOLARE - REGULAR JOIST - VIGA REGULAR

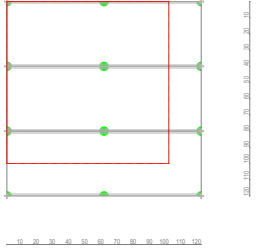

numero basamenti al m2	4,17
ml travetto al m2	2,50
ml profilo silenziatore al m2	5,00
numero elemento fuga al m2	2,08
number of supports per m2	4,17
lm joist per m2	2,50
lm silencer profile per m2	5,00
number of spacer element per m2	2,08
número soportes por m2	4,17
ml viga por m2	2,50
ml perfil de almohadilla por m2	5,00
número elemento junta por m2	2,08

CENTRALI - CENTRAL - CENTRALES
TRAVETTO ORTOGONALE - ORTHOGONAL JOIST - VIGA ORTOGONAL

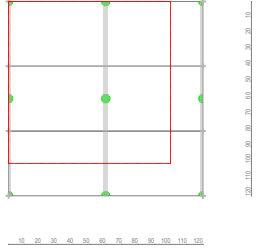

numero basamenti al m2	2,78 pezzi
ml travetto al m2	1,67 ml
ml profilo silenziatore al m2	3,34 ml
numero elemento fuga al m2	2,08 pezzi
number of supports per m2	2,78 pezzi
lm joist per m2	1,67 ml
lm silencer profile per m2	3,34 ml
number of spacer element per m2	2,08 pezzi
número soportes por m2	2,78 pezzi
ml viga por m2	1,67 ml
ml perfil de almohadilla por m2	3,34 ml
número elemento junta por m2	2,08 pezzi

PERIMETRALI - PERIMETRAL - PERIMATRALES
TRAVETTO REGOLARE - REGULAR JOIST - VIGA REGULAR

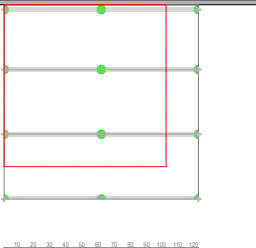

numero basamenti al m2	4,86
ml travetto al m2	2,92
ml profilo silenziatore al m2	5,84
numero elemento fuga al m2	2,43
number of supports per m2	4,86
lm joist per m2	2,92
lm silencer profile per m2	5,84
number of spacer element per m2	2,43
número soportes por m2	4,86
ml viga por m2	2,92
ml perfil de almohadilla por m2	5,84
número elemento junta por m2	2,43

PERIMETRALI - PERIMETRAL - PERIMATRALES
TRAVETTO ORTOGONALE - ORTHOGONAL JOIST - VIGA ORTOGONAL

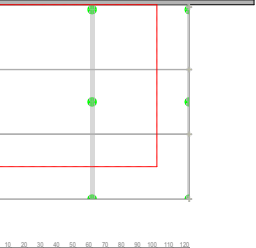

numero basamenti al m2	3,47
ml travetto al m2	1,67
ml profilo silenziatore al m2	3,34
numero elemento fuga al m2	2,43
number of supports per m2	3,47
lm joist per m2	1,67
lm silencer profile per m2	3,34
number of spacer element per m2	2,43
número soportes por m2	3,47
ml viga por m2	1,67
ml perfil de almohadilla por m2	3,34
número elemento junta por m2	2,43

ANGOLARI - ANGULAR - ANGULARES
TRAVETTO REGOLARE - REGULAR JOIST - VIGA REGULAR

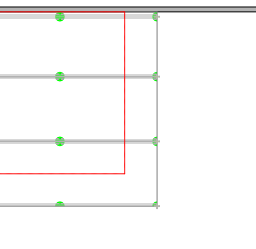

numero basamenti al m2	6,08
ml travetto al m2	2,92
ml profilo silenziatore al m2	5,84
numero elemento fuga al m2	2,95
number of supports per m2	6,08
lm joist per m2	2,92
lm silencer profile per m2	5,84
number of spacer element per m2	2,95
número soportes por m2	6,08
ml viga por m2	2,92
ml perfil de almohadilla por m2	5,84
número elemento junta por m2	2,95

ANGOLARI - ANGULAR - ANGULARES
TRAVETTO ORTOGONALE - ORTHOGONAL JOIST - VIGA ORTOGONAL

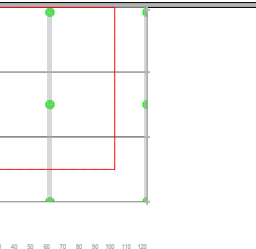

numero basamenti al m2	4,34
ml travetto al m2	2,08
ml profilo silenziatore al m2	4,16
numero elemento fuga al m2	2,95
number of supports per m2	4,34
lm joist per m2	2,08
lm silencer profile per m2	4,16
number of spacer element per m2	2,95
número soportes por m2	4,34
ml viga por m2	2,08
ml perfil de almohadilla por m2	4,16
número elemento junta por m2	2,95

LEGENDA - LEGEND - LEGENDA

- 1 mq
- 1 sq. m
- 1 mc
- Linea perimetrale
- Perimetral line
- Línea perimetral
- Linea d'angolo
- Corner line
- Línea de ángulo
- Basamento
- Support
- Soporte
- Elemento fuga
- Spacer element
- Elemento junta
- Travetto
- Joist
- Viga

I quantitativi possono variare in funzione dell'area da pavimentare.
Quantities can varied based on the geometry of the area to be paved.
Las cantidades pueden variar de acuerdo con la zona que se deba solar.

FORMATO RETTANGOLARE - RECTANGULAR SHAPED - FORMATO RECTANGULAR

60 x 120 cm

CENTRALI - CENTRAL - CENTRALES
TRAVETTO REGOLARE - REGULAR JOIST - VIGA REGULAR

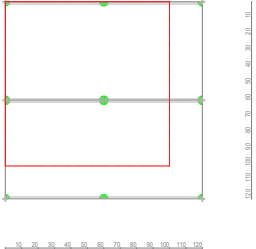

numero basamenti al m2	2,78
ml travetto al m2	1,67
ml profilo silenziatore al m2	3,34
numero elemento fuga al m2	1,39
number of supports per m2	2,78
lm joist per m2	1,67
lm silencer profile per m2	3,34
number of spacer element per m2	1,39
número soportes por m2	2,78
ml viga por m2	1,67
ml perfil de almohadilla por m2	3,34
número elemento junta por m2	1,39

CENTRALI - CENTRAL - CENTRALES
TRAVETTO ORTOGONALE - ORTHOGONAL JOIST - VIGA ORTOGONAL

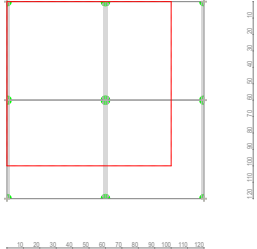

numero basamenti al m2	2,78
ml travetto al m2	1,67
ml profilo silenziatore al m2	3,34
numero elemento fuga al m2	1,39
number of supports per m2	2,78
lm joist per m2	1,67
lm silencer profile per m2	3,34
number of spacer element per m2	1,39
número soportes por m2	2,78
ml viga por m2	1,67
ml perfil de almohadilla por m2	3,34
número elemento junta por m2	1,39

PERIMETRALI - PERIMETRAL - PERIMATRALES
TRAVETTO REGOLARE - REGULAR JOIST - VIGA REGULAR

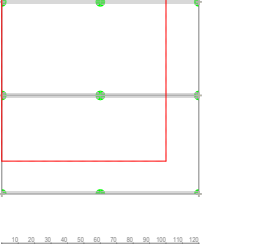

numero basamenti al m2	3,47
ml travetto al m2	2,08
ml profilo silenziatore al m2	4,16
numero elemento fuga al m2	1,74
number of supports per m2	3,47
lm joist per m2	2,08
lm silencer profile per m2	4,16
number of spacer element per m2	1,74
número soportes por m2	3,47
ml viga por m2	2,08
ml perfil de almohadilla por m2	4,16
número elemento junta por m2	1,74

PERIMETRALI - PERIMETRAL - PERIMATRALES
TRAVETTO ORTOGONALE - ORTHOGONAL JOIST - VIGA ORTOGONAL

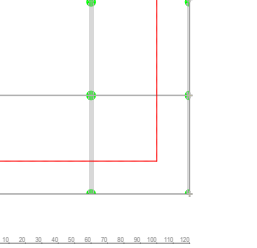

numero basamenti al m2	3,47
ml travetto al m2	1,67
ml profilo silenziatore al m2	3,34
numero elemento fuga al m2	1,74
number of supports per m2	3,47
lm joist per m2	1,67
lm silencer profile per m2	3,34
number of spacer element per m2	1,74
número soportes por m2	3,47
ml viga por m2	1,67
ml perfil de almohadilla por m2	3,34
número elemento junta por m2	1,74

ANGOLARI - ANGULAR - ANGULARES
TRAVETTO REGOLARE - REGULAR JOIST - VIGA REGULAR

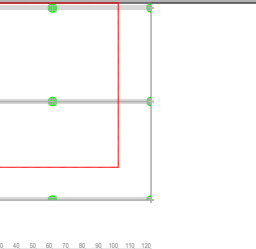

numero basamenti al m2	4,34
ml travetto al m2	2,08
ml profilo silenziatore al m2	4,16
numero elemento fuga al m2	1,91
number of supports per m2	4,34
lm joist per m2	2,08
lm silencer profile per m2	4,16
number of spacer element per m2	1,91
número soportes por m2	4,34
ml viga por m2	2,08
ml perfil de almohadilla por m2	4,16
número elemento junta por m2	1,91

ANGOLARI - ANGULAR - ANGULARES
TRAVETTO ORTOGONALE - ORTHOGONAL JOIST - VIGA ORTOGONAL

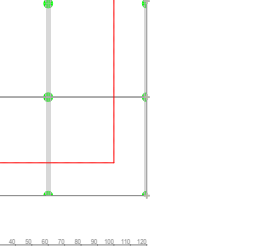

numero basamenti al m2	4,34
ml travetto al m2	2,08
ml profilo silenziatore al m2	4,16
numero elemento fuga al m2	1,91
number of supports per m2	4,34
lm joist per m2	2,08
lm silencer profile per m2	4,16
number of spacer element per m2	1,91
número soportes por m2	4,34
ml viga por m2	2,08
ml perfil de almohadilla por m2	4,16
número elemento junta por m2	1,91

LEGENDA - LEGEND - LEGENDA

 1 mq 1 sq. m 1 mc	 Linea perimetrale Perimetral line Línea perimetral	 Linea d'angolo Corner line Línea de ángulo	 Basamento Support Soporte	 Elemento fuga Spacer element Elemento junta	 Travetto Joist Viga
---	--	--	---	---	---

I quantitativi possono variare in funzione dell'area da pavimentare.
 Quantities can varied based on the geometry of the area to be paved.
 Las cantidades pueden variar de acuerdo con la zona que se deba solar.

FORMATO RETTANGOLARE - RECTANGULAR SHAPED - FORMATO RECTANGULAR

30 x 180 cm

CENTRALI - CENTRAL - CENTRALES
TRAVETTO REGOLARE - REGULAR JOIST - VIGA REGULAR

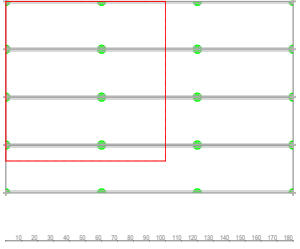

numero basamenti al m2	5,56
ml travetto al m2	3,33
ml profilo silenziatore al m2	6,66
numero elemento fuga al m2	1,85
number of supports per m2	5,56
lm joist per m2	3,33
lm silencer profile per m2	6,66
number of spacer element per m2	1,85
número soportes por m2	5,56
ml viga por m2	3,33
ml perfil de almohadilla por m2	6,66
número elemento junta por m2	1,85

CENTRALI - CENTRAL - CENTRALES
TRAVETTO ORTOGONALE - ORTHOGONAL JOIST - VIGA ORTOGONAL

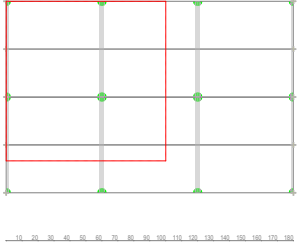

numero basamenti al m2	2,78
ml travetto al m2	1,67
ml profilo silenziatore al m2	3,34
numero elemento fuga al m2	1,85
number of supports per m2	2,78
lm joist per m2	1,67
lm silencer profile per m2	3,34
number of spacer element per m2	1,85
número soportes por m2	2,78
ml viga por m2	1,67
ml perfil de almohadilla por m2	3,34
número elemento junta por m2	1,85

PERIMETRALI - PERIMETRAL - PERIMATRALES
TRAVETTO REGOLARE - REGULAR JOIST - VIGA REGULAR

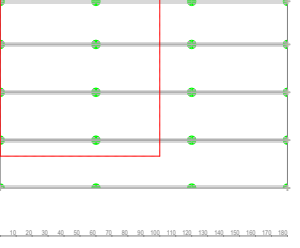

numero basamenti al m2	6,25
ml travetto al m2	3,75
ml profilo silenziatore al m2	7,50
numero elemento fuga al m2	2,08
number of supports per m2	6,25
lm joist per m2	3,75
lm silencer profile per m2	7,50
number of spacer element per m2	2,08
número soportes por m2	6,25
ml viga por m2	3,75
ml perfil de almohadilla por m2	7,50
número elemento junta por m2	2,08

PERIMETRALI - PERIMETRAL - PERIMATRALES
TRAVETTO ORTOGONALE - ORTHOGONAL JOIST - VIGA ORTOGONAL

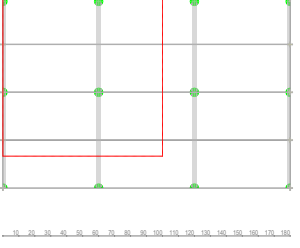

numero basamenti al m2	3,47
ml travetto al m2	1,67
ml profilo silenziatore al m2	3,34
numero elemento fuga al m2	2,08
number of supports per m2	3,47
lm joist per m2	1,67
lm silencer profile per m2	3,34
number of spacer element per m2	2,08
número soportes por m2	3,47
ml viga por m2	1,67
ml perfil de almohadilla por m2	3,34
número elemento junta por m2	2,08

ANGOLARI - ANGULAR - ANGULARES
TRAVETTO REGOLARE - REGULAR JOIST - VIGA REGULAR

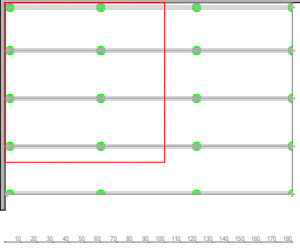

numero basamenti al m2	7,29
ml travetto al m2	3,75
ml profilo silenziatore al m2	7,50
numero elemento fuga al m2	2,66
number of supports per m2	7,29
lm joist per m2	3,75
lm silencer profile per m2	7,50
number of spacer element per m2	2,66
número soportes por m2	7,29
ml viga por m2	3,75
ml perfil de almohadilla por m2	7,50
número elemento junta por m2	2,66

ANGOLARI - ANGULAR - ANGULARES
TRAVETTO ORTOGONALE - ORTHOGONAL JOIST - VIGA ORTOGONAL

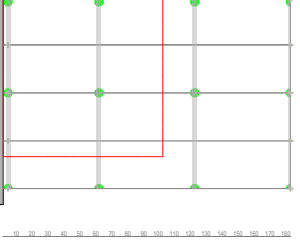

numero basamenti al m2	4,05
ml travetto al m2	1,94
ml profilo silenziatore al m2	3,88
numero elemento fuga al m2	2,66
number of supports per m2	4,05
lm joist per m2	1,94
lm silencer profile per m2	3,88
number of spacer element per m2	2,66
número soportes por m2	4,05
ml viga por m2	1,94
ml perfil de almohadilla por m2	3,88
número elemento junta por m2	2,66

LEGENDA - LEGEND - LEGENDA

- 1 mq
- 1 sq. m
- 1 mc
- Linea perimetrale
- Perimetral line
- Línea perimetral
- Linea d'angolo
- Corner line
- Línea de ángulo
- Basamento
- Support
- Soporte
- Elemento fuga
- Spacer element
- Elemento junta
- Travetto
- Joist
- Viga

I quantitativi possono variare in funzione dell'area da pavimentare.
 Quantities can varied based on the geometry of the area to be paved.
 Las cantidades pueden variar de acuerdo con la zona que se deba solar.

FORMATO RETTANGOLARE - RECTANGULAR SHAPED - FORMATO RECTANGULAR

40 x 180 cm

CENTRALI - CENTRAL - CENTRALES TRAVETTO REGOLARE - REGULAR JOIST - VIGA REGULAR

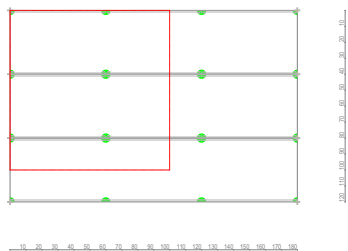

numero basamenti al m2	4,17
ml travetto al m2	2,50
ml profilo silenziatore al m2	5,00
numero elemento fuga al m2	1,39
number of supports per m2	4,17
lm joist per m2	2,50
lm silencer profile per m2	5,00
number of spacer element per m2	1,39
número soportes por m2	4,17
ml viga por m2	2,50
ml perfil de almohadilla por m2	5,00
número elemento junta por m2	1,39

CENTRALI - CENTRAL - CENTRALES TRAVETTO ORTOGONALE - ORTHOGONAL JOIST - VIGA ORTOGONAL

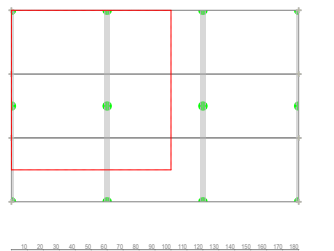

numero basamenti al m2	2,78
ml travetto al m2	1,67
ml profilo silenziatore al m2	3,34
numero elemento fuga al m2	1,39
number of supports per m2	2,78
lm joist per m2	1,67
lm silencer profile per m2	3,34
number of spacer element per m2	1,39
número soportes por m2	2,78
ml viga por m2	1,67
ml perfil de almohadilla por m2	3,34
número elemento junta por m2	1,39

PERIMETRALI - PERIMETRAL - PERIMATRALES TRAVETTO REGOLARE - REGULAR JOIST - VIGA REGULAR

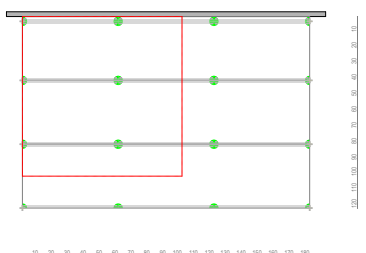

numero basamenti al m2	4,86
ml travetto al m2	2,92
ml profilo silenziatore al m2	5,84
numero elemento fuga al m2	1,62
number of supports per m2	4,86
lm joist per m2	2,92
lm silencer profile per m2	5,84
number of spacer element per m2	1,62
número soportes por m2	4,86
ml viga por m2	2,92
ml perfil de almohadilla por m2	5,84
número elemento junta por m2	1,62

PERIMETRALI - PERIMETRAL - PERIMATRALES TRAVETTO ORTOGONALE - ORTHOGONAL JOIST - VIGA ORTOGONAL

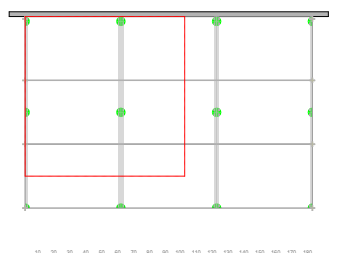

numero basamenti al m2	3,47
ml travetto al m2	1,67
ml profilo silenziatore al m2	3,34
numero elemento fuga al m2	1,62
number of supports per m2	3,47
lm joist per m2	1,67
lm silencer profile per m2	3,34
number of spacer element per m2	1,62
número soportes por m2	3,47
ml viga por m2	1,67
ml perfil de almohadilla por m2	3,34
número elemento junta por m2	1,62

ANGOLARI - ANGULAR - ANGULARES TRAVETTO REGOLARE - REGULAR JOIST - VIGA REGULAR

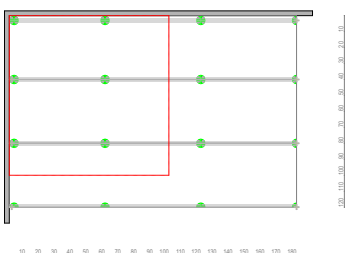

numero basamenti al m2	5,67
ml travetto al m2	2,92
ml profilo silenziatore al m2	5,84
numero elemento fuga al m2	1,97
number of supports per m2	5,67
lm joist per m2	2,92
lm silencer profile per m2	5,84
number of spacer element per m2	1,97
número soportes por m2	5,67
ml viga por m2	2,92
ml perfil de almohadilla por m2	5,84
número elemento junta por m2	1,97

ANGOLARI - ANGULAR - ANGULARES TRAVETTO ORTOGONALE - ORTHOGONAL JOIST - VIGA ORTOGONAL

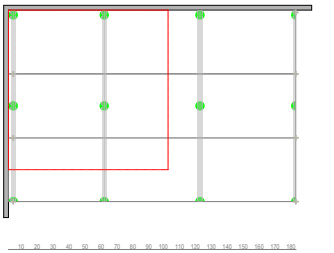

numero basamenti al m2	4,05
ml travetto al m2	1,94
ml profilo silenziatore al m2	3,88
numero elemento fuga al m2	1,97
number of supports per m2	4,05
lm joist per m2	1,94
lm silencer profile per m2	3,88
number of spacer element per m2	1,97
número soportes por m2	4,05
ml viga por m2	1,94
ml perfil de almohadilla por m2	3,88
número elemento junta por m2	1,97

LEGENDA - LEGEND - LEGENDA

1 mq 1 sq. m 1 mc	Linea perimetrale Perimetral line Línea perimetral	Linea d'angolo Corner line Línea de ángulo	Basamento Support Soporte	Elemento fuga Spacer element Elemento junta	Travetto Joist Viga
-------------------------	--	--	---------------------------------	---	---------------------------

I quantitativi possono variare in funzione dell'area da pavimentare.
Quantities can varied based on the geometry of the area to be paved.
Las cantidades pueden variar de acuerdo con la zona que se deba solar.



ITALPROFILI[®]
RESISTANT TO TIME



CONSUMI A MQ. DUAL SYSTEM EVOLUTION CON FINITURA PAVIMENTAZIONE DECKING

Le seguenti tabelle indicano il fabbisogno a mq dei componenti del sistema Dual System Evolution per pavimentazioni sopraelevate con finitura decking.

I conteggi sono stati sviluppati con posa del travetto Dual System Evolution per porzioni di aree da pavimentare:

- Centrali
- Perimetrali
- Angolari

Sono stati considerati interassi di appoggio dei basamenti di 40, 50 e 60 cm. sul travetto, mentre gli interassi tra i travetti di 35, 40, 45 e 50 cm. da verificare secondo le indicazioni del produttore delle doghe della pavimentazione.

CONSUMPTIONS OF DUAL SYSTEM EVOLUTION PER SQM. WITH DECKING FLOORING

The following tables indicate the requirements per square meter of the components of the Dual System Evolution for raised floors with decking.

The calculations have been developed with the installation of the Dual System Evolution joist for portions of areas to be paved:

- Central
- Perimetral
- Angular

It has been considered a center distance of the supports of 40, 50 and 60 cm on the joist, while the distance between the joists is 35, 40, 45 and 50 cm. to be verified according to the indications of the manufacturer of the flooring staves.

CONSUMOS POR M2 DUAL SYSTEM EVOLUTION CON ACABADO PAVIMENTO DE TARIMA

Las siguientes tablas indican las necesidades por m2 de los componentes del sistema Dual System Evolution para suelos elevados con acabados de tarima.

Los recuentos se han realizado con la puesta de la viga Dual System Evolution para las partes de suelo que solar.

- Centrales
- Perimetrales
- Angulares

Se han considerado distancias entre ejes de apoyo de los soportes de 40, 50 y 60 cm en la viga, mientras que las distancias entre ejes entre las vigas de 35, 40, 45 y 50 cm se deben comprobar según las indicaciones del fabricante de los listones del pavimento.

INTERASSE BASAMENTI - CENTER DISTANCE OF SUPPORTS - DISTANCIA ENTRE EJES SOPORTES 40 cm INTERASSE TRAVETTI - CENTER DISTANCE OF JOISTS - DISTANCIA ENTRE EJES VIGAS 35 cm

CENTRALI CENTRAL CENTRALES	numero basamenti al m2 7,14 ml travetto al m2 2,86 number of supports per m2 7,14 lm joist per m2 2,86 número soportes por m2 7,14 ml viga por m2 2,86	PERIMETRALI PERIMETRAL PERIMETRALES	numero basamenti al m2 8,33 ml travetto al m2 2,86 number of supports per m2 8,33 lm joist per m2 2,86 número soportes por m2 8,33 ml viga por m2 2,86	ANGOLARI ANGULAR ANGULARES	numero basamenti al m2 9,38 ml travetto al m2 3,21 number of supports per m2 9,38 lm joist per m2 3,21 número soportes por m2 9,38 ml viga por m2 3,21

INTERASSE BASAMENTI - CENTER DISTANCE OF SUPPORTS - DISTANCIA ENTRE EJES SOPORTES 40 cm INTERASSE TRAVETTI - CENTER DISTANCE OF JOISTS - DISTANCIA ENTRE EJES VIGAS 40 cm

CENTRALI CENTRAL CENTRALES	numero basamenti al m2 6,25 ml travetto al m2 2,50 number of supports per m2 6,25 lm joist per m2 2,50 número soportes por m2 6,25 ml viga por m2 2,50	PERIMETRALI PERIMETRAL PERIMETRALES	numero basamenti al m2 7,29 ml travetto al m2 2,50 number of supports per m2 7,29 lm joist per m2 2,50 número soportes por m2 7,29 ml viga por m2 2,50	ANGOLARI ANGULAR ANGULARES	numero basamenti al m2 8,51 ml travetto al m2 2,92 number of supports per m2 8,51 lm joist per m2 2,92 número soportes por m2 8,51 ml viga por m2 2,92

LEGENDA - LEGEND - LEGENDA

1 mq 1 sq. m 1 mc	Basamento Support Soporte	Travetto Joist Viga	Linea perimetrale Perimetral line Línea perimetral	Pavimentazione decking Decking flooring Pavimento de tarima	Linea d'angolo Corner line Línea de ángulo
-------------------------	---------------------------------	---------------------------	--	---	--

I quantitativi possono variare in funzione dell'area da pavimentare.
Quantities can varied based on the geometry of the area to be paved.
Las cantidades pueden variar de acuerdo con la zona que se deba solar.



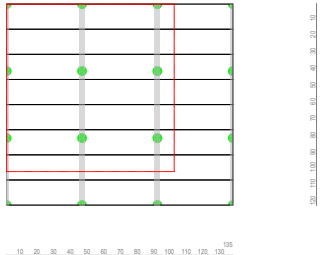
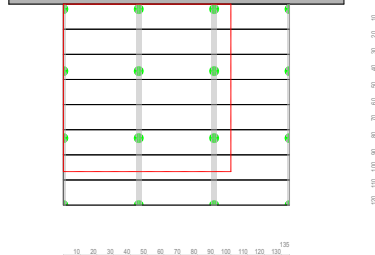
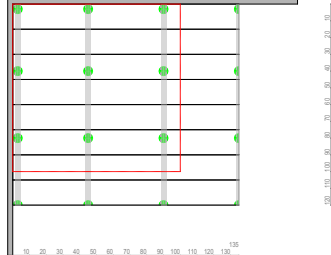

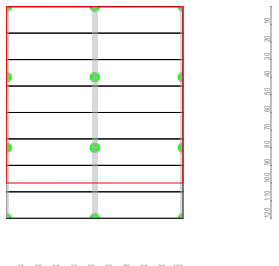
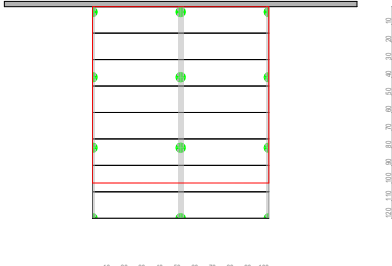
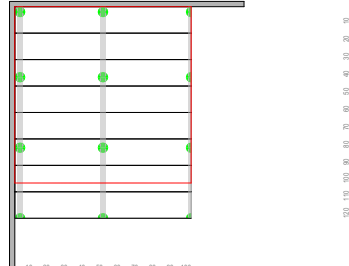

INTERASSE BASAMENTI - CENTER DISTANCE OF SUPPORTS - DISTANCIA ENTRE EJES SOPORTES 40 cm
INTERASSE TRAVETTI - CENTER DISTANCE OF JOISTS - DISTANCIA ENTRE EJES VIGAS 45 cm

<p>CENTRALI CENTRAL CENTRALES</p>	<p>PERIMETRALI PERIMETRAL PERIMETRALES</p>	<p>ANGOLARI ANGULAR ANGULARES</p>
<p>numero basamenti al m2 5,56 ml travetto al m2 2,22</p> <p>number of supports per m2 5,56 lm joist per m2 2,22</p> <p>número soportes por m2 5,56 ml viga por m2 2,22</p> 	<p>numero basamenti al m2 6,48 ml travetto al m2 2,22</p> <p>number of supports per m2 6,48 lm joist per m2 2,22</p> <p>número soportes por m2 6,48 ml viga por m2 2,22</p> 	<p>numero basamenti al m2 7,56 ml travetto al m2 2,59</p> <p>number of supports per m2 7,56 lm joist per m2 2,59</p> <p>número soportes por m2 7,56 ml viga por m2 2,59</p> 

INTERASSE BASAMENTI - CENTER DISTANCE OF SUPPORTS - DISTANCIA ENTRE EJES SOPORTES 40 cm
INTERASSE TRAVETTI - CENTER DISTANCE OF JOISTS - DISTANCIA ENTRE EJES VIGAS 50 cm

<p>CENTRALI CENTRAL CENTRALES</p>	<p>PERIMETRALI PERIMETRAL PERIMETRALES</p>	<p>ANGOLARI ANGULAR ANGULARES</p>
<p>numero basamenti al m2 5,00 ml travetto al m2 2,00</p> <p>number of supports per m2 5,00 lm joist per m2 2,00</p> <p>número soportes por m2 5,00 ml viga por m2 2,00</p> 	<p>numero basamenti al m2 5,83 ml travetto al m2 2,00</p> <p>number of supports per m2 5,83 lm joist per m2 2,00</p> <p>número soportes por m2 5,83 ml viga por m2 2,00</p> 	<p>numero basamenti al m2 7,29 ml travetto al m2 2,50</p> <p>number of supports per m2 7,29 lm joist per m2 2,50</p> <p>número soportes por m2 7,29 ml viga por m2 2,50</p> 

LEGENDA - LEGEND - LEGENDA

 1 mq 1 sq. m 1 mc	 Basamento Support Soporte	 Travetto Joist Viga	 Linea perimetrale Perimetral line Línea perimetral	 Pavimentazione decking Decking flooring Pavimento de tarima	 Linea d'angolo Corner line Línea de ángulo
---	---	---	--	---	--

I quantitativi possono variare in funzione dell'area da pavimentare.
 Quantities can varied based on the geometry of the area to be paved.
 Las cantidades pueden variar de acuerdo con la zona que se deba solar.



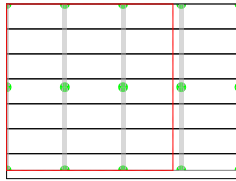
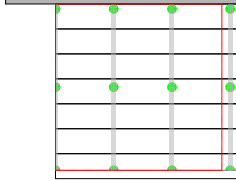
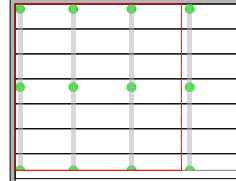

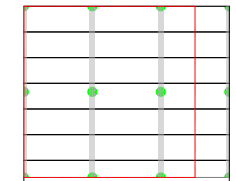
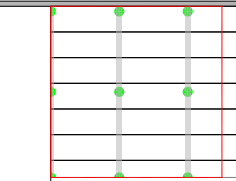
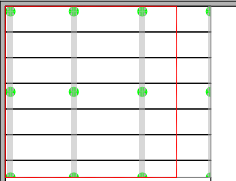

INTERASSE BASAMENTI - CENTER DISTANCE OF SUPPORTS - DISTANCIA ENTRE EJES SOPORTES 50 cm
INTERASSE TRAVETTI - CENTER DISTANCE OF JOISTS - DISTANCIA ENTRE EJES VIGAS 35 cm

<p>CENTRALI CENTRAL CENTRALES</p> <p>numero basamenti al m2 5,71 ml travetto al m2 2,86</p> <p>number of supports per m2 5,71 lm joist per m2 2,86</p> <p>número soportes por m2 5,71 ml viga por m2 2,86</p>	<p>PERIMETRALI PERIMETRAL PERIMETRALES</p> <p>numero basamenti al m2 7,14 ml travetto al m2 2,86</p> <p>number of supports per m2 7,14 lm joist per m2 2,86</p> <p>número soportes por m2 7,14 ml viga por m2 2,86</p>	<p>ANGOLARI ANGULAR ANGULARES</p> <p>numero basamenti al m2 8,04 ml travetto al m2 3,21</p> <p>number of supports per m2 8,04 lm joist per m2 3,21</p> <p>número soportes por m2 8,04 ml viga por m2 3,21</p>
		

INTERASSE BASAMENTI - CENTER DISTANCE OF SUPPORTS - DISTANCIA ENTRE EJES SOPORTES 50 cm
INTERASSE TRAVETTI - CENTER DISTANCE OF JOISTS - DISTANCIA ENTRE EJES VIGAS 40 cm

<p>CENTRALI CENTRAL CENTRALES</p> <p>numero basamenti al m2 5,00 ml travetto al m2 2,50</p> <p>number of supports per m2 5,00 lm joist per m2 2,50</p> <p>número soportes por m2 5,00 ml viga por m2 2,50</p>	<p>PERIMETRALI PERIMETRAL PERIMETRALES</p> <p>numero basamenti al m2 6,25 ml travetto al m2 2,50</p> <p>number of supports per m2 6,25 lm joist per m2 2,50</p> <p>número soportes por m2 6,25 ml viga por m2 2,50</p>	<p>ANGOLARI ANGULAR ANGULARES</p> <p>numero basamenti al m2 7,29 ml travetto al m2 2,92</p> <p>number of supports per m2 7,29 lm joist per m2 2,92</p> <p>número soportes por m2 7,29 ml viga por m2 2,92</p>
		

LEGENDA - LEGEND - LEGENDA

 1 mq 1 sq. m 1 mc	 Basamento Support Soporte	 Travetto Joist Viga	 Linea perimetrale Perimetral line Línea perimetral	 Pavimentazione decking Decking flooring Pavimento de tarima	 Linea d'angolo Corner line Línea de ángulo
---	---	---	--	---	--

I quantitativi possono variare in funzione dell'area da pavimentare.
 Quantities can varied based on the geometry of the area to be paved.
 Las cantidades pueden variar de acuerdo con la zona que se deba solar.

INTERASSE BASAMENTI - CENTER DISTANCE OF SUPPORTS - DISTANCIA ENTRE EJES SOPORTES 50 cm INTERASSE TRAVETTI - CENTER DISTANCE OF JOISTS - DISTANCIA ENTRE EJES VIGAS 45 cm

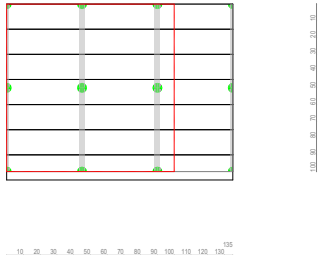
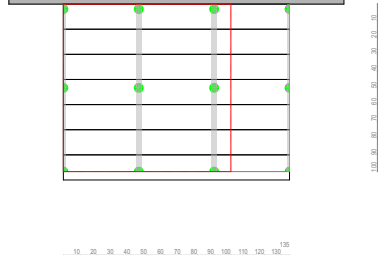
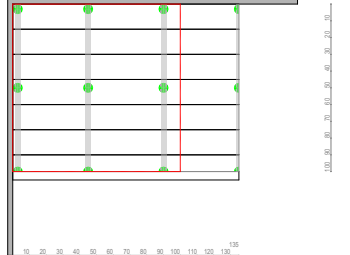
CENTRALI CENTRAL CENTRALES	PERIMETRALI PERIMETRAL PERIMETRALES	ANGOLARI ANGULAR ANGULARES
numero basamenti al m2 4,44 ml travetto al m2 2,22 number of supports per m2 4,44 lm joist per m2 2,22 número soportes por m2 4,44 ml viga por m2 2,22	numero basamenti al m2 5,56 ml travetto al m2 2,22 number of supports per m2 5,56 lm joist per m2 2,22 número soportes por m2 5,56 ml viga por m2 2,22	numero basamenti al m2 6,48 ml travetto al m2 2,59 number of supports per m2 6,48 lm joist per m2 2,59 número soportes por m2 6,48 ml viga por m2 2,59
		

INTERASSE BASAMENTI - CENTER DISTANCE OF SUPPORTS - DISTANCIA ENTRE EJES SOPORTES 50 cm INTERASSE TRAVETTI - CENTER DISTANCE OF JOISTS - DISTANCIA ENTRE EJES VIGAS 50 cm

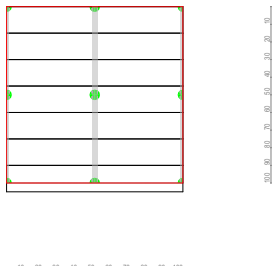
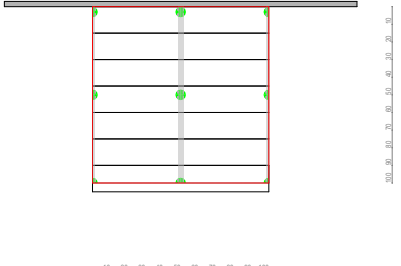
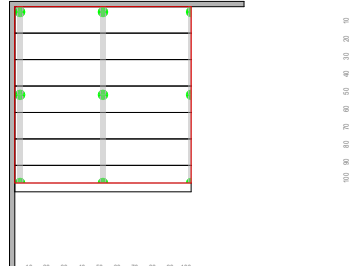
CENTRALI CENTRAL CENTRALES	PERIMETRALI PERIMETRAL PERIMETRALES	ANGOLARI ANGULAR ANGULARES
numero basamenti al m2 4,00 ml travetto al m2 2,00 number of supports per m2 4,00 lm joist per m2 2,00 número soportes por m2 4,00 ml viga por m2 2,00	numero basamenti al m2 5,00 ml travetto al m2 2,00 number of supports per m2 5,00 lm joist per m2 2,00 número soportes por m2 5,00 ml viga por m2 2,00	numero basamenti al m2 6,25 ml travetto al m2 2,50 number of supports per m2 6,25 lm joist per m2 2,50 número soportes por m2 6,25 ml viga por m2 2,50
		

LEGENDA - LEGEND - LEGENDA

1 mq 1 sq. m 1 mc	● Basamento Support Soporte	— Travetto Joist Viga	— Linea perimetrale Perimetral line Línea perimetral	▭ Pavimentazione decking Decking flooring Pavimento de tarima	└ Linea d'angolo Corner line Línea de ángulo
-------------------------	-----------------------------------	-----------------------------	--	---	--

I quantitativi possono variare in funzione dell'area da pavimentare.
 Quantities can varied based on the geometry of the area to be paved.
 Las cantidades pueden variar de acuerdo con la zona que se deba solar.



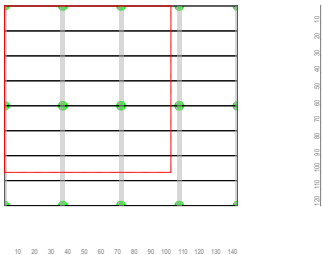
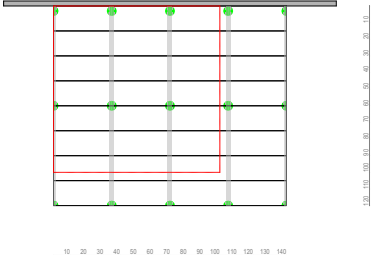
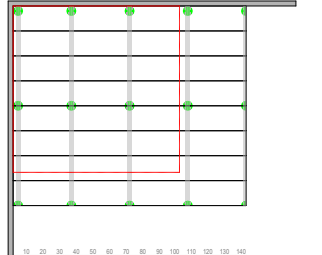

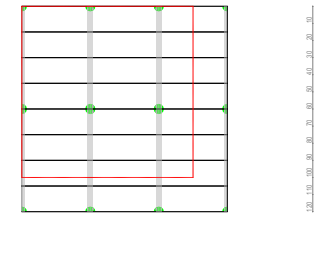
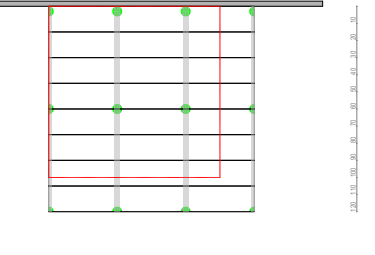
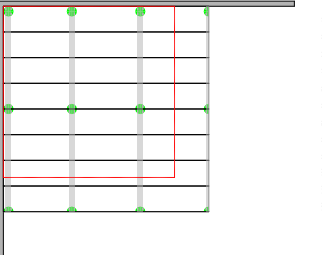

INTERASSE BASAMENTI - CENTER DISTANCE OF SUPPORTS - DISTANCIA ENTRE EJES SOPORTES 60 cm INTERASSE TRAVETTI - CENTER DISTANCE OF JOISTS - DISTANCIA ENTRE EJES VIGAS 35 cm

<p>CENTRALI CENTRAL CENTRALES</p> <p>numero basamenti al m2 4,76 ml travetto al m2 2,86</p> <p>number of supports per m2 4,76 lm joist per m2 2,86</p> <p>número soportes por m2 4,76 ml viga por m2 2,86</p>	<p>PERIMETRALI PERIMETRAL PERIMETRALES</p> <p>numero basamenti al m2 5,95 ml travetto al m2 2,86</p> <p>number of supports per m2 5,95 lm joist per m2 2,86</p> <p>número soportes por m2 5,95 ml viga por m2 2,86</p>	<p>ANGOLARI ANGULAR ANGULARES</p> <p>numero basamenti al m2 6,70 ml travetto al m2 3,21</p> <p>number of supports per m2 6,70 lm joist per m2 3,21</p> <p>número soportes por m2 6,70 ml viga por m2 3,21</p>
		

INTERASSE BASAMENTI - CENTER DISTANCE OF SUPPORTS - DISTANCIA ENTRE EJES SOPORTES 60 cm INTERASSE TRAVETTI - CENTER DISTANCE OF JOISTS - DISTANCIA ENTRE EJES VIGAS 40 cm

<p>CENTRALI CENTRAL CENTRALES</p> <p>numero basamenti al m2 4,17 ml travetto al m2 2,50</p> <p>number of supports per m2 4,17 lm joist per m2 2,50</p> <p>número soportes por m2 4,17 ml viga por m2 2,50</p>	<p>PERIMETRALI PERIMETRAL PERIMETRALES</p> <p>numero basamenti al m2 5,21 ml travetto al m2 2,50</p> <p>number of supports per m2 5,21 lm joist per m2 2,50</p> <p>número soportes por m2 5,21 ml viga por m2 2,50</p>	<p>ANGOLARI ANGULAR ANGULARES</p> <p>numero basamenti al m2 6,08 ml travetto al m2 2,92</p> <p>number of supports per m2 6,08 lm joist per m2 2,92</p> <p>número soportes por m2 6,08 ml viga por m2 2,92</p>
		

LEGENDA - LEGEND - LEGENDA

 1 mq 1 sq. m 1 mc	 Basamento Support Soporte	 Travetto Joist Viga	 Linea perimetrale Perimetral line Línea perimetral	 Pavimentazione decking Decking flooring Pavimento de tarima	 Linea d'angolo Corner line Línea de ángulo
---	---	---	--	---	--

I quantitativi possono variare in funzione dell'area da pavimentare.
Quantities can varied based on the geometry of the area to be paved.
Las cantidades pueden variar de acuerdo con la zona que se deba solar.



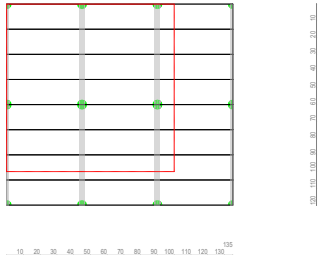
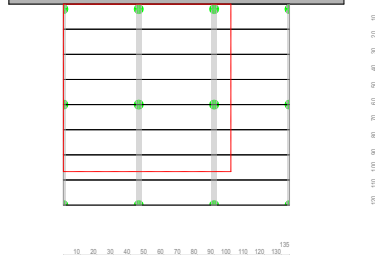
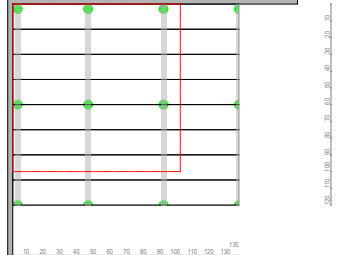

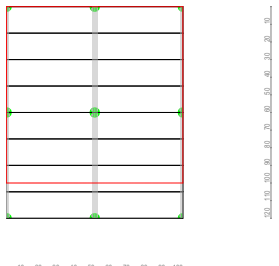
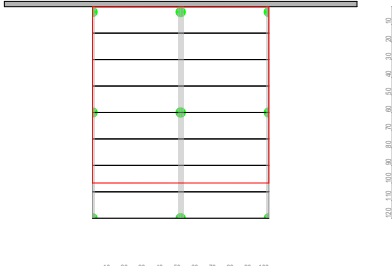
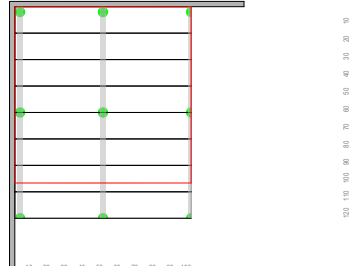

INTERASSE BASAMENTI - CENTER DISTANCE OF SUPPORTS - DISTANCIA ENTRE EJES SOPORTES 60 cm
INTERASSE TRAVETTI - CENTER DISTANCE OF JOISTS - DISTANCIA ENTRE EJES VIGAS 45 cm

<p>CENTRALI CENTRAL CENTRALES</p> <p>numero basamenti al m2 3,70 ml travetto al m2 2,22</p> <p>number of supports per m2 3,70 lm joist per m2 2,22</p> <p>número soportes por m2 3,70 ml viga por m2 2,22</p>	<p>PERIMETRALI PERIMETRAL PERIMETRALES</p> <p>numero basamenti al m2 4,63 ml travetto al m2 2,22</p> <p>number of supports per m2 4,63 lm joist per m2 2,22</p> <p>número soportes por m2 4,63 ml viga por m2 2,22</p>	<p>ANGOLARI ANGULAR ANGULARES</p> <p>numero basamenti al m2 5,40 ml travetto al m2 2,59</p> <p>number of supports per m2 5,40 lm joist per m2 2,59</p> <p>número soportes por m2 5,40 ml viga por m2 2,59</p>
		

INTERASSE BASAMENTI - CENTER DISTANCE OF SUPPORTS - DISTANCIA ENTRE EJES SOPORTES 60 cm
INTERASSE TRAVETTI - CENTER DISTANCE OF JOISTS - DISTANCIA ENTRE EJES VIGAS 50 cm

<p>CENTRALI CENTRAL CENTRALES</p> <p>numero basamenti al m2 3,33 ml travetto al m2 2,00</p> <p>number of supports per m2 3,33 lm joist per m2 2,00</p> <p>número soportes por m2 3,33 ml viga por m2 2,00</p>	<p>PERIMETRALI PERIMETRAL PERIMETRALES</p> <p>numero basamenti al m2 4,17 ml travetto al m2 2,00</p> <p>number of supports per m2 4,17 lm joist per m2 2,00</p> <p>número soportes por m2 4,17 ml viga por m2 2,00</p>	<p>ANGOLARI ANGULAR ANGULARES</p> <p>numero basamenti al m2 5,21 ml travetto al m2 2,50</p> <p>number of supports per m2 5,21 lm joist per m2 2,50</p> <p>número soportes por m2 5,21 ml viga por m2 2,50</p>
		

LEGENDA - LEGEND - LEGENDA

 1 mq 1 sq. m 1 mc	 Basamento Support Soporte	 Travetto Joist Viga	 Linea perimetrale Perimetral line Línea perimetral	 Pavimentazione decking Decking flooring Pavimento de tarima	 Linea d'angolo Corner line Línea de ángulo
---	---	---	--	---	--

I quantitativi possono variare in funzione dell'area da pavimentare.
 Quantities can varied based on the geometry of the area to be paved.
 Las cantidades pueden variar de acuerdo con la zona que se deba solar.

BASAMENTI REGOLABILI LINEA SPECIAL



SPECIAL

ADJUSTABLE SUPPORT SYSTEMS SPECIAL

SOPORTES REGULABLES LÍNEA SPECIAL



PORTATA CERTIFICATA DA 2190 A 3000 KG
CERTIFICATI DISPONIBILI A RICHIESTA

CERTIFIED LOAD CAPACITY FROM 2190 TO 3000 KG
CERTIFICATES AVAILABLE ON REQUEST

CAPACIDAD DE CARGA CERTIFICADA DE 2190 A 3000 KG
CERTIFICADOS DISPONIBLES A PETICIÓN



SPECIAL



SPECIAL FH



SPECIAL MF

I **BASAMENTI REGOLABILI** della serie "SPECIAL" sono studiati per dare un sostegno robusto e autolivellante alle pavimentazioni sopraelevate. I basamenti regolabili Special sono i supporti per pavimentazioni galleggianti con la maggiore portata disponibile nel mercato. Data la loro versatilità possono essere impiegati sia internamente che esternamente e con diverse tipologie di pavimentazioni quali piastre prefabbricate, piastrelle in gres porcellanato, marmo, pietra, legno, legno composito. Vengono utilizzati come supporti autolivellanti al di sotto di una pavimentazione sopraelevata, per rendere praticabili zone impermeabilizzate e non, permettere il passaggio di cavi e tubazioni che sono di norma presenti in uffici, negozi ed ambienti di lavoro. Per questo motivo le pavimentazioni sopraelevate sono utilizzate soprattutto nelle nuove costruzioni o negli interventi di ristrutturazione dove è richiesta massima flessibilità progettuale e facilità d'ispezione dell'impermeabilizzazione e degli impianti a terra. Il materiale utilizzato per la realizzazione dei basamenti regolabili Special è polipropilene di prima scelta opportunamente additivato per garantire lunga durata nel tempo e aumentare la resistenza di portata.

The **ADJUSTABLE PAVING SUPPORT SYSTEMS "SPECIAL"** are designed to give a strong and robust support for raised floors. The adjustable paving support Special for raised floors also has one of the highest load capacities available on the market today. Because of its versatility, it can be used on both internal or external projects, it can also be used with a wide range of different types of paving, for example, prefabricated slabs, porcelain, marble or stone, wood and composite wood. It is the perfect solution for turning non practicable areas into practicable ones, whether they are waterproofed and not, it also allows for the passage of cables, pipes etc that are normally present in offices, shops and work environments. For this reason, raised floors are mainly used in new buildings or in renovation where maximum design and flexibility is required or simply to ease the inspection of the waterproofing layer or any pipes, cables etc. The adjustable paving support Special are produced using only the finest top grade polypropylene and additives, these top quality raw materials ensure their long durability and also increase the load capacity.

Los **SOPORTES REGULABLES** de la serie "SPECIAL" están diseñados para proporcionar un soporte robusto y autonivelante a los suelos elevados. Los soportes regulables Special son los soportes para suelos elevados con la mayor capacidad de carga disponible en el mercado. Por su versatilidad, se pueden usar tanto en interiores como exteriores y con diferentes tipos de suelos, tales como losas prefabricadas, baldosas de gres porcelánico, mármol, piedra, madera y madera compuesta. Se utilizan como soportes autonivelantes debajo de un suelo elevado para volver practicable las zonas impermeabilizadas y otros tipos de zonas, permitir el paso de cables y tuberías que por lo general se encuentran en oficinas, tiendas y entornos de trabajo. Por este motivo, los suelos elevados se utilizan sobre todo en las nuevas construcciones o en las obras de reestructuración donde se requiere la máxima flexibilidad de diseño y una fácil inspección de la impermeabilización y de las instalaciones que pasan por el suelo. El material utilizado para la realización de los soportes regulables Special es el polipropileno de primera calidad con aditivos adecuados para garantizar una larga duración y aumentar la resistencia de carga.



SPECIAL JOIST



SPECIAL JOIST FH

BASAMENTI REGOLABILI LINEA SPECIAL

ADJUSTABLE SUPPORT SYSTEMS SPECIAL

SOPORTES REGULABLES LÍNEA SPECIAL

La filettatura delle viti presenta una dentatura nella parte inferiore che funge da autobloccaggio, eliminando eventuali ghiere. Essa una volta ultimata la pavimentazione va ad esercitare una pressione creando una incisione sui filetti della base in modo tale da crearne un bloccaggio, evitando così spiacevoli alterazioni del livello della pavimentazione causati dallo svitamento-avvitamento dovuto alle vibrazioni durante il calpestio o di altra natura. Con tale sistema si evitano interventi di regolazione quote a distanza di tempo dal montaggio.

The thread of the screw features teeth in the lower section which provide the self-locking function, creating an incision in the thread of the base which locks the position, thus preventing the possibility of changes in the leveling of the floor caused by movements resulting from vibrations caused by persons walking on the floor or other causes. This system makes it unnecessary to intervene at a later date in order to adjust the leveling of the floor subsequent to installation.

Las roscas de los tornillos tienen un diente en la parte inferior que actúa como autobloqueante, eliminando el montaje de casquillos. Al concluir la pavimentación, la rosca ejerce una presión creando una incisión en las roscas de la base de manera de crear un bloqueo, evitando así alteraciones desagradables del nivel del pavimento causadas por el desenroscado-enroscado debido a las vibraciones provocadas por las pisadas o de otro tipo. Con este sistema se evitan las operaciones de regulación de la altura transcurrido un período de tiempo después del montaje.

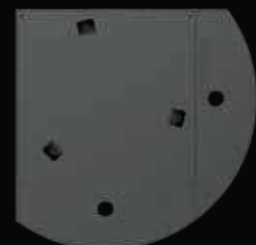
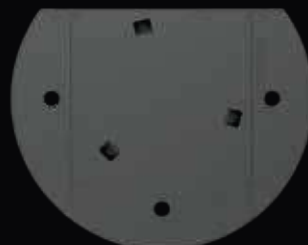
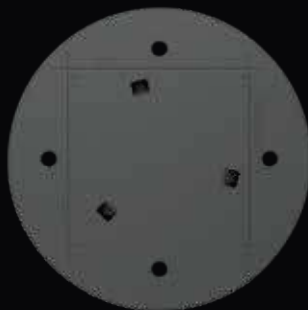

La base presenta dei fori appositamente studiati per l'ottimale scarico dell'acqua e nella parte sottostante degli incavi guida per il taglio della base permettendo la posa a filo parete o in un angolo.

The base supports features holes specifically designed to assure perfect drainage of water and under the base are located the lines sections for cutting and position the base on the corners or perimetral areas.

La base tiene orificios específicamente estudiados para un desagüe correcto del agua y en la parte inferior de las ranuras de guía para el corte de la base, permitiendo la colocación al ras de la pared o en una esquina.

Art. 186.4

PROLUNGA A MANICOTTO - SLEEVE EXTENSION - EXTENSION CON MANGUITO

Con la prolunga a manicotto si possono raggiungere altezze fino a 1 metro e oltre. È applicabile solo sugli Art. 185.4, 185.4FH, 185.4MF, 185.4J, 185.4JFH svitando completamente la vite dalla base e inserendo la prolunga tra di esse facendo attenzione a bloccarla come da foto illustrative.

The sleeve extension can be stacked up to a height of 1 metre. Applicable only on Art. 185.4, 185.4FH, 185.4MF, 185.4J, 185.4JFH by pulling out completely the threaded support install the sleeve extension self-locking as shown on the pictures.

Con la extensión con manguito se pueden alcanzar alturas de hasta 1 m y más. Es aplicable solo en los Arts. 185.4, 185.4FH, 185.4MF, 185.4J, 185.4JFH desenroscando completamente el tornillo de la base e introduciendo la extensión entre ellos, asegurándose de bloquearla como se muestra en las fotos.



Esse sono impilabili su se stesse, autobloccanti e permettono un range finale di regolazione di 100 mm.

They are stackable, self-locking and provide a final adjustment range of 100 mm.

Son apilables entre sí, autobloqueantes y permiten un rango de regulación final de 100 mm.

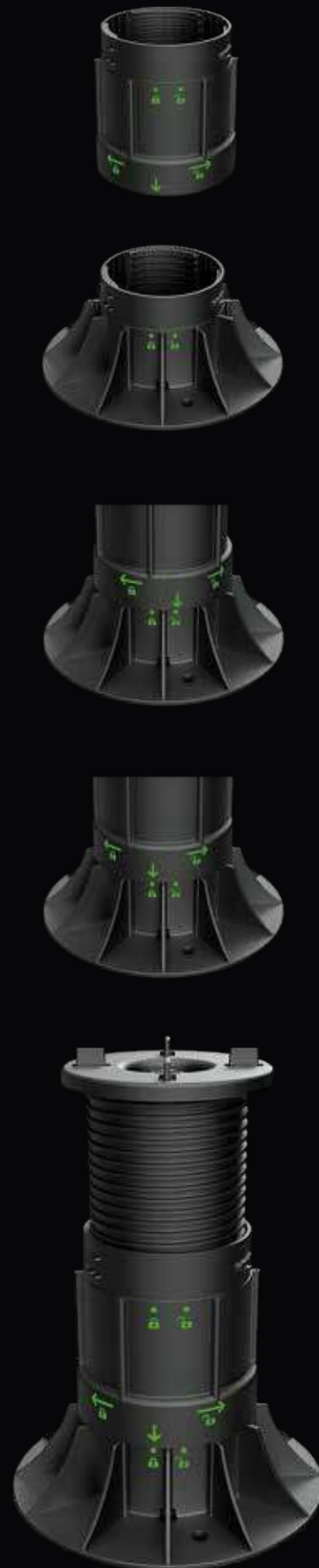



PENDENZA AUTOLIVELLANTE

La linea di supporti "SPECIAL" grazie alla testa autolivellante risolve il problema dei dislivelli e permette di livellare in modo automatico fino al 9% circa di pendenza. È possibile posare il supporto direttamente sulla superficie inclinata senza utilizzare componenti aggiuntivi.

SELF-LEVELING SLOPE

The paving support systems "SPECIAL" thanks to the self-leveling head solve the problem of the differences in level and allow to automatically level up to about 9% of slope. It is possible to lay the support directly on the inclined surface without using additional components.

PENDIENTE AUTONIVELANTE

La línea de soportes "SPECIAL", gracias a la cabeza autonivelante, resuelve el problema de los desniveles y permite nivelar automáticamente hasta el 9 % aprox. de pendiente. Es posible colocar el soporte directamente sobre la superficie inclinada sin utilizar componentes adicionales.

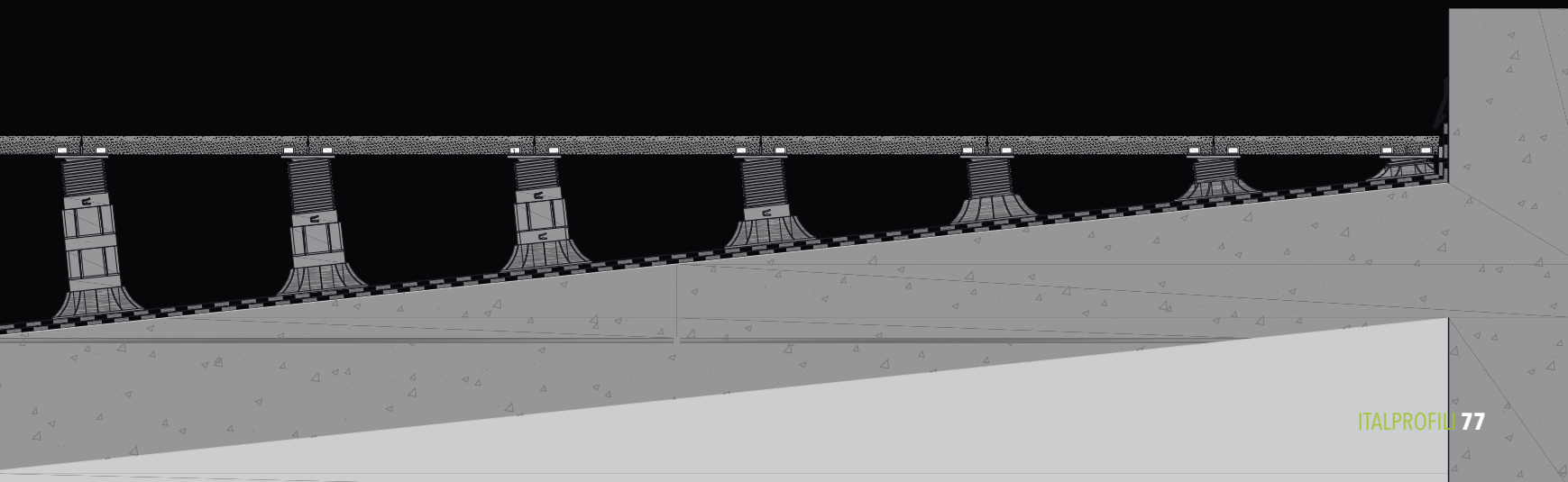

PAVIMENTAZIONI SOPRAELEVATE DA ESTERNO
RAISED FLOORS FOR EXTERIORS
SUELOS ELEVADOS PARA EXTERIORES

SPECIAL CON TESTA AUTOLIVELLANTE

SPECIAL WITH SELF-LEVELING HEAD

SPECIAL CON CABEZA AUTONIVELANTE

BASAMENTO REGOLABILE
ADJUSTABLE PAVING SUPPORT
SOPORTE REGULABLE

Art. 185	40 ÷ 56 mm
Art. 185.1	50 ÷ 70 mm
Art. 185.2	70 ÷ 110 mm
Art. 185.3	110 ÷ 160 mm
Art. 185.4	150 ÷ 210 mm
Art. 185.5	200 ÷ 300 mm
Art. 185.6	300 ÷ 400 mm
Art. 185.7	400 ÷ 500 mm
Art. 185.8	500 ÷ 600 mm
Art. 185.9	600 ÷ 700 mm
Art. 185.10	700 ÷ 800 mm
Art. 185.11	800 ÷ 900 mm
Art. 185.12	900 ÷ 1.000 mm



TESTA PIANA - FLAT HEAD - CABEZA PLANA



2 mm - h 10 mm

ALETTE FUGA - THICK SPACERS - ALETAS JUNTA



3 mm - h 10 mm

ALETTE FUGA - THICK SPACERS - ALETAS JUNTA



4 mm - h 10 mm

ALETTE FUGA - THICK SPACERS - ALETAS JUNTA



6 mm - h 10 mm

ALETTE FUGA - THICK SPACERS - ALETAS JUNTA



8 mm - h 10 mm

ALETTE FUGA - THICK SPACERS - ALETAS JUNTA



10 mm - h 10 mm

ALETTE FUGA - THICK SPACERS - ALETAS JUNTA

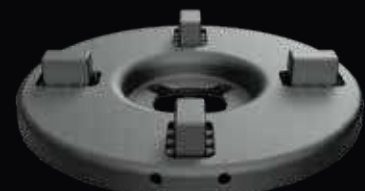

TESTA AUTOLIVELLANTE / SELF-LEVELING HEAD / CABEZA AUTONIVELANTE

La testa autolivellante disponibile in versione piana, con alette fuga pre-intagliate con spessore 2, 3, 4, 6, 8, 10 mm. e Ø 130 mm. ha il vantaggio, in presenza di pendenze, di poter posare in opera il basamento direttamente sulla superficie inclinata senza bisogno di componenti aggiuntivi. Tale caratteristica ci permette di livellare in maniera del tutto automatica inclinazioni fino ad un massimo del 9% circa.

The self-leveling head is available in flat version or with pre-cut 2, 3, 4, 6, 8, 10 mm spacers and Ø 130 mm. it is especially advantageous when installing on an inclined surface, since the support can be placed directly on the inclined surface without the need for any supplementary components. This feature makes it possible to provide automatic leveling for inclinations up to 9%.

La cabeza autonivelante, disponible en la versión plana, con aletas junta precortadas de 2, 3, 4, 6, 8 y 10 mm de espesor y Ø 130 mm, en caso de pendientes, tiene la ventaja de poder colocar in situ el soporte directamente sobre la superficie inclinada sin la necesidad de componentes adicionales. Dicha característica permite nivelar automáticamente las inclinaciones de hasta un máximo del 9% aprox.

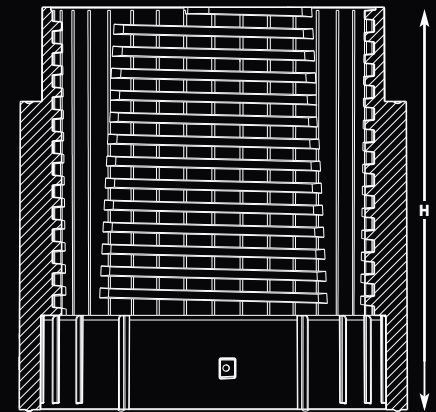
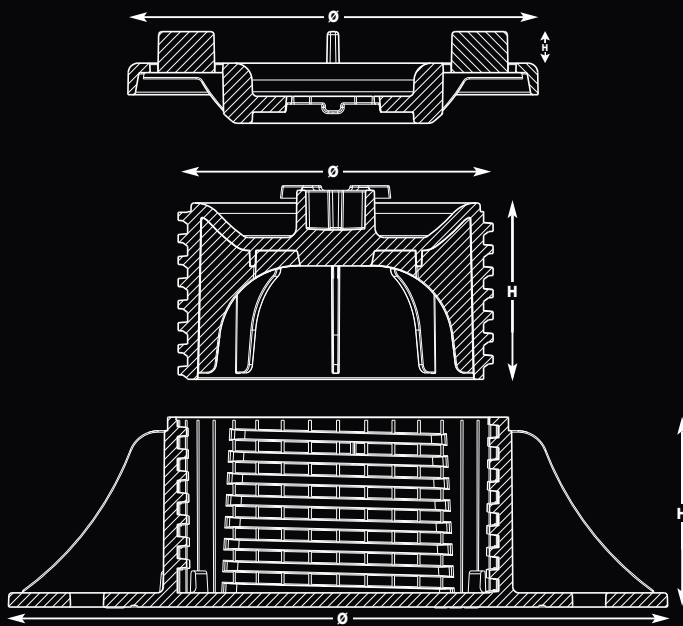

COMPOSIZIONE BASAMENTI REGOLABILI SPECIAL / COMPOSITION OF ADJUSTABLE SUPPORTS SPECIAL / COMPOSICIÓN SOPORTES REGULABLES SPECIAL

ARTICOLO CODE ART. ARTÍCULO	MISURE SIZE MEDIDAS		BASE BASE BASE		VITE FILETTATA THREADED SCREW TORNILLO ROSCADO		PROLUNGA A MANICOTTO THREADED EXTENSION EXTENSIÓN CON MANGUITO		TESTA AUTO LIVELLANTE SELF-LEVELING HEAD CABEZA AUTONIVELANTE		
	da mm. from mm. de mm.	a mm. to mm. a mm.	Ø mm.	h. mm.	Ø mm.	h. mm.	pezzi n. pieces n. cant. piezas	h. mm.	Ø mm.	h. mm.	livellamento max % max slope % nivelación máx. %
185	40	56	210	30	101.8	26			130	10	± 9
185.1	50	70	210	40	101.8	36			130	10	± 9
185.2	70	110	210	60	101.8	56			130	10	± 9
185.3	110	160	220	90	101.8	86			130	10	± 9
185.4	150	210	220	90	101.8	136			130	10	± 9
185.5	200	300	220	90	101.8	136	1	130	130	10	± 9
185.6	300	400	220	90	101.8	136	2	130	130	10	± 9
185.7	400	500	220	90	101.8	136	3	130	130	10	± 9
185.8	500	600	220	90	101.8	136	4	130	130	10	± 9
185.9	600	700	220	90	101.8	136	5	130	130	10	± 9
185.10	700	800	220	90	101.8	136	6	130	130	10	± 9
185.11	800	900	220	90	101.8	136	7	130	130	10	± 9
185.12	900	1.000	220	90	101.8	136	8	130	130	10	± 9

Per garantire la portata e la perfetta efficienza del sistema di regolazione, si raccomanda di non oltrepassare la misura massima dichiarata nella descrizione del prodotto.

In order to guarantee the perfect efficiency of the regulation system, it is highly recommended not to exceed the maximum height indicated in the product description.

Para garantizar la capacidad de carga y la perfecta eficiencia del sistema de regulación, se recomienda no superar la medida máxima indicada en la descripción del producto.

ARTICOLI OPZIONALI SPECIAL

OPTIONAL ITEMS SPECIAL

ARTÍCULOS OPCIONALES SPECIAL

Art. 186.3

DISTANZIALI PERIMETRALI - PERIMETRAL SPACER - DILATADORES PERIMETRALES

Inseriti direttamente nella testa autolivellante hanno uno spessore minimo di 4 mm. e permettono di tenere distanziata la pavimentazione dal perimetro di contenimento. Questo accorgimento annulla lo sfregamento della pavimentazione sulla membrana impermeabilizzante ove sia applicata con risvolto nella parete verticale ed evita l'accumulo di sporizia, la quale potrebbe limitare l'evacuazione delle precipitazioni meteoriche. Tale misura di 4 mm. può essere moltiplicata essendo i distanziali impilabili.

Inserted directly into the self-leveling head they have a minimum thickness of 4 mm. and keep the flooring at a distance from the external perimeter; this prevents the flooring from rubbing against the waterproofing membrane where it is applied with a folded edge against the vertical wall, and prevents the accumulation of dirt, which might impede the drainage of rainwater. Since the spacers can be stacked, the thickness of 4 mm. can also be multiplied.

Colocados directamente en la cabeza autonivelante, tienen un espesor mínimo de 4 mm y permiten mantener separado el suelo del perímetro de contención. Esta solución cancela el roce del suelo sobre la membrana impermeabilizante cuando esté aplicada con una solapa en la pared vertical y evita la acumulación de suciedad, lo que podría limitar la evacuación del agua de lluvia. Dicha medida de 4 mm se puede aumentar porque los dilatadores son apilables.



Art. 186.4

PROLUNGA A MANICOTTO - SLEEVE EXTENSION - EXTENSIÓN CON MANGUITO

La prolunga manicotto è applicabile solo su Art. 185.4 e consente di raggiungere altezze fino ad 1 metro e oltre, mantenendo un range di regolazione finale di 100 mm.

The sleeve extension is applicable on Art. 185.4 and allows to reach heights up to 1 metre and above, maintaining a final adjustment of 100 mm.

La extensión con manguito solo se aplica en el Art. 185.4 y permite alcanzar alturas de hasta 1 metro y más, manteniendo un rango de regulación final de 100 mm.



Art. 185HS

SILENZIATORE TESTA ANTISDRUCCIOLO - NON-SLIP HEAD SILENCER - ALMOHADILLA CABEZA ANTIDESLIZANTE

I silenziatori per teste prodotti in gomma fonoassorbente e antisdrucciolo sono studiati per abbattere il rumore derivante dal calpestio presente nelle pavimentazioni sopraelevate, inoltre fungono anche da antisdrucciolo per la pavimentazione installata. Vengono installati direttamente sulla parte superiore della testa e non necessitano di essere fissati.

The silencers for heads produced in sound-absorbing and non-slip rubber are designed to reduce the noise deriving from the trampling present in the raised floors, and also act as non-skid for the installed flooring. They are installed directly on the top of the head and they do not need to be fixed.

Las almohadillas para cabezas producidas en caucho insonorizante y antideslizante están diseñadas para reducir el ruido provocado por las pisadas en los suelos elevados y también actúan como antideslizante para el suelo instalado. Se instalan directamente en la parte superior de la cabeza y no necesitan ser fijadas.



Art. 186.6

CHIAVE DI REGOLAZIONE ITALPROFILI 50 CM ITALPROFILI REGULATING KEY 50 CM LLAVE DE REGULACIÓN ITALPROFILI 50 CM

Chiave di regolazione l. 500 mm., utilizzabile a pavimentazione ultimata con fughe 4 - 6 - 8 - 10 mm.

Regulating key l. 500 mm., used for paving completed with 4 - 6 - 8 - 10 mm spacers.

Llave de regulación de 500 mm. de largo, que se utiliza con el suelo terminado con juntas de 4 - 6 - 8 - 10 mm.



Art. 186.6 C

CHIAVE DI REGOLAZIONE ITALPROFILI 25 CM ITALPROFILI REGULATING KEY 25 CM LLAVE DE REGULACIÓN ITALPROFILI 25 CM

Chiave di regolazione l. 250 mm., utilizzabile a pavimentazione ultimata con fughe 4 - 6 - 8 - 10 mm.

Regulating key l. 250 mm., used for paving completed with 4 - 6 - 8 - 10 mm spacers.

Llave de regulación de 250 mm. de largo, que se utiliza con el suelo terminado con juntas de 4 - 6 - 8 - 10 mm.



Art. 186.5

SPESSORE LIVELLANTE - LEVELING SPACER - ESPESOR NIVELANTE

Lo spessore livellante da 1,5 a 5 mm. può essere usato interamente, è impilabile o sezionabile per 1/2 o 1/4. Viene impiegato nei casi in cui la superficie di appoggio sia molto irregolare o per colmare i dislivelli creati dai sormonti del manto impermeabile. Può essere utilizzato anche per aumentare l'altezza finale del basamento di 5 mm.

The leveling spacer, from 1,5 to 5 mm. , can be used as a whole, and can also be stacked or sectioned by 1/2 or 1/4. These components are used when the support surface is extremely irregular or to compensate for the differences in level created by overlaps in the waterproofing layer. It can also be used to increase the final height with 5 mm.

El espesor nivelante de 1,5 a 5 mm se puede utilizar por completo, apilar o cortar por 1/2 o 1/4. Se utiliza cuando la superficie de apoyo es muy irregular o para colmar los desniveles creados por el solapado de la membrana impermeable. También se puede utilizar para aumentar 5 mm la altura final del soporte.



Art. 185CV2 - 185CV4

SET CLIP CHIUSURA VERTICALI FUGA 2/4 mm - SET CLIP FOR VERTICAL CLOSURE SPACER 2/4 mm - JUEGO DE CERRAMIENTOS VERTICALES JUNTA 2/4 mm

I set clip chiusura verticali Italprofili sono studiati per dare un aggancio robusto ed esteticamente gradevole alle chiusure dei bordi perimetrali verticali nelle pavimentazioni sopraelevate, creando così un contenimento perimetrale per la pavimentazione. Realizzate in acciaio inox spessore 0,8 mm. sono disponibili con fuga 2 o 4 mm.

The Italprofili set clip for vertical closure is designed to give a strong and aesthetically pleasing attachment to the closing of the vertical perimeter edges in raised floors, thus creating a perimeter containment for the flooring. Made of 0,8 mm thick stainless steel, they are available with 2 or 4 mm spacers.

Los juegos de cerramientos verticales Italprofili están diseñados para un enganche fuerte y estéticamente agradable en los remates de los bordes perimetrales verticales en los suelos elevados, creando así una contención perimetral para el pavimento. Hechos de acero inoxidable de 0,8 mm de espesor, están disponibles con juntas de 2 o 4 mm.

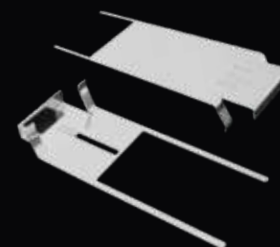

Art. 185DP2 - 185DP4

DISTANZIALE PERIMETRALE INOX FUGA 2/4 mm - PERIMETRAL SPACER STAINLESS STEEL FOR HEAD SPACER 2/4 mm - DILATADOR PERIMETRAL ACERO INOX JUNTA 2/4 mm

Il distanziale perimetrale viene posato direttamente sopra la testa permettendo di tenere distanziata di 5 mm. la pavimentazione dal perimetro verticale di contenimento. Opportunamente sagomato per evitare lo sfregamento della pavimentazione sul perimetro verticale di contenimento ed assorbire eventuali movimenti e dilatazioni della pavimentazione. Realizzato in acciaio inox, spessore di 0,8 mm.

The perimetral spacer is laid directly on the head allowing to keep the flooring of a distance of 5 mm from the vertical containment perimeter. Suitably shaped to avoid the rubbing of the pavement on the vertical containment perimeter and to absorb any movement and expansion of the pavement. Made of stainless steel, 0,8 mm thick.

El dilatador perimetral se coloca directamente sobre la cabeza, permitiendo mantener el pavimento a 5 mm de distancia del perímetro vertical de contención. Tiene una forma adecuada para evitar que el pavimento frote sobre el perímetro vertical de contención y para absorber posibles movimientos y dilataciones del pavimento. Está hecho de acero inoxidable de 0,8 mm de espesor.



Art. 190

PINZA POSAPIASTRE PER PIASTRE DI LATO 30 - 35 - 40 - 45 - 50 CM PAVING SLAB HANDLER 30 - 35 - 40 - 45 - 50 CM PINZA ESPESORADA PARA LOSAS DE 30 - 35 - 40 - 45 - 50 CM DE LADO



Art. 195

VENTOSA ALZAPIASTRELLE 110KG SUCTION CUP TILE LIFTER 110KG VENTOSA SUBIDA BALDOSAS 110 KG



VOCE DI CAPITOLATO DEI BASAMENTI REGOLABILI SPECIAL DESCRIPTION FOR SPECIFICATION OF THE ADJUSTABLE SPECIAL PAVING SUPPORTS ESPECIFICACIONES TÉCNICAS DE LOS SOPORTES REGULABLES SPECIAL

BASAMENTI REGOLABILI SPECIAL

Fornitura e posa in opera di basamenti regolabili del tipo Italprofili linea Special in polipropilene, per la realizzazione di pavimentazioni sopraelevate da esterno con finitura ceramica.

Il basamento è composto da:

- Base filettata
- Vite filettata
- Testa Special autolivellante con fuga disponibile da 2,3,4,6,8, e 10 mm.

ADJUSTABLE SPECIAL PAVING SUPPORTS

Supply and installation of adjustable Special paving supports made of polypropylene, for the realisation of raised floors for exteriors with ceramic.

The support consists of:

- Threaded base
- Threaded screw
- Self-levelling head Special with spacer-tabs available in 2,3,4,6,8, and 10 mm.

SOPORTES REGULABLES SPECIAL

Suministro y puesta en obra de soportes regulables de tipo Italprofili línea Special de polipropileno, para la realización de suelos elevados de exterior con acabado cerámico.

La base se compone de:

- Base roscada
- Tornillo roscado
- Cabeza Special autonivelante con junta disponible de 2,3,4,6,8 y 10 mm.

PAVIMENTAZIONI SOPRAELEVATE DA ESTERNO
 RAISED FLOORS FOR EXTERIORS
 SUELOS ELEVADOS PARA EXTERIORES

SPECIAL FH CON TESTA FISSA

SPECIAL FH WITH FIXED HEAD

SPECIAL FH CON CABEZA FIJA

BASAMENTO REGOLABILE
 ADJUSTABLE PAVING SUPPORT
 SOPORTE REGULABLE

Art. 185FH	40 ÷ 56 mm
Art. 185.1FH	50 ÷ 70 mm
Art. 185.2FH	70 ÷ 110 mm
Art. 185.3FH	110 ÷ 160 mm
Art. 185.4FH	150 ÷ 210 mm
Art. 185.5FH	200 ÷ 300 mm
Art. 185.6FH	300 ÷ 400 mm
Art. 185.7FH	400 ÷ 500 mm
Art. 185.8FH	500 ÷ 600 mm
Art. 185.9FH	600 ÷ 700 mm
Art. 185.10FH	700 ÷ 800 mm
Art. 185.11FH	800 ÷ 900 mm
Art. 185.12FH	900 ÷ 1.000 mm



TESTA PIANA - FLAT HEAD - CABEZA PLANA

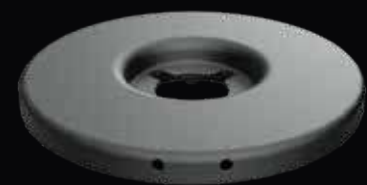

2 mm - h 10 mm

ALETTE FUGA - THICK SPACERS - ALETAS JUNTA



3 mm - h 10 mm

ALETTE FUGA - THICK SPACERS - ALETAS JUNTA



4 mm - h 10 mm

ALETTE FUGA - THICK SPACERS - ALETAS JUNTA



6 mm - h 10 mm

ALETTE FUGA - THICK SPACERS - ALETAS JUNTA



8 mm - h 10 mm

ALETTE FUGA - THICK SPACERS - ALETAS JUNTA

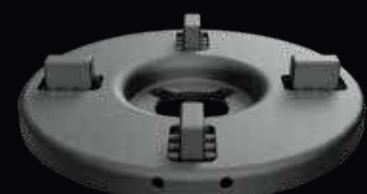

10 mm - h 10 mm

ALETTE FUGA - THICK SPACERS - ALETAS JUNTA

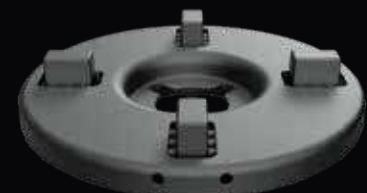

TESTA FISSA / FIXED HEAD / CABEZA FIJA

La testa fissa è disponibile in versione piana, con alette fuga pre-intagliate con spessore 2, 3, 4, 6, 8, 10 mm. e Ø 130 mm.

The fixed head is available in the flat version or with pre-cut 2, 3, 4, 6, 8, 10 mm spacers Ø 130 mm.

La cabeza fija está disponible en versión plana, con aletas junta precortadas de 2, 3, 4, 6, 8 y 10 mm de espesor y Ø 130 mm.

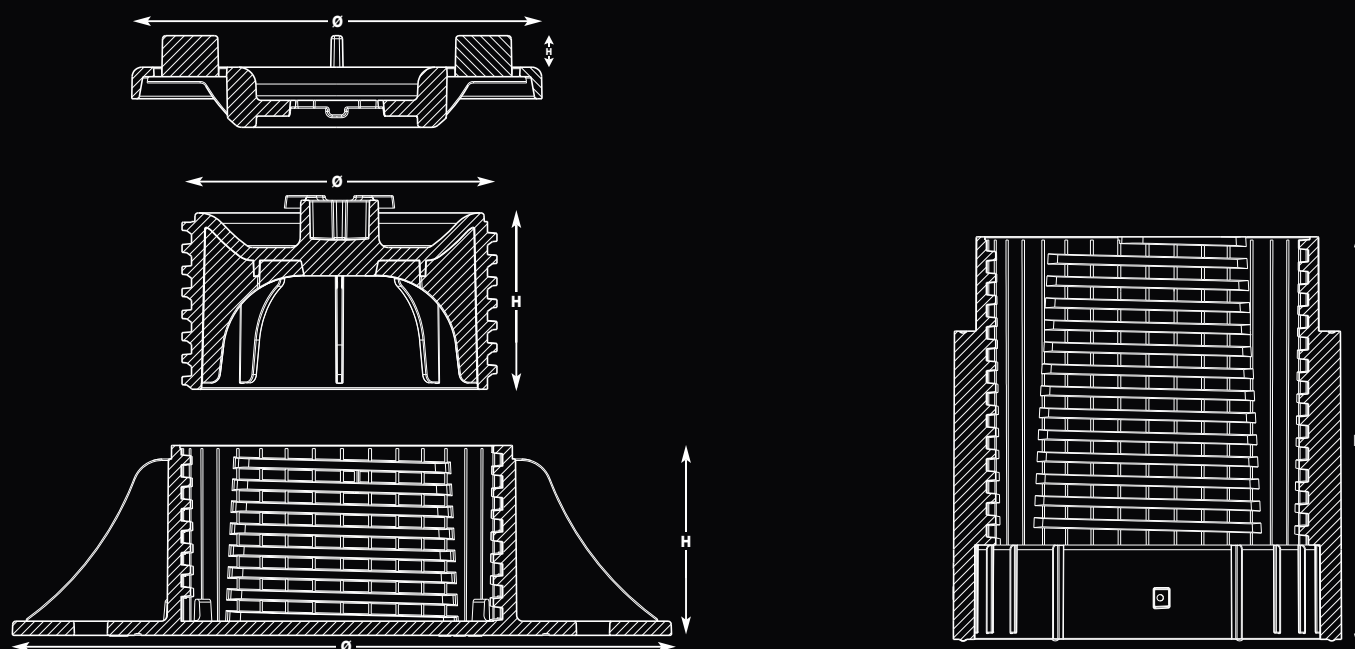

COMPOSIZIONE BASAMENTI REGOLABILI SPECIAL FH / COMPOSITION OF ADJUSTABLE SUPPORTS SPECIAL FH / COMPOSICIÓN SOPORTES REGULABLES SPECIAL FH

ARTICOLO CODE ART ARTÍCULO	MISURE SIZE MEDIDAS		BASE BASE BASE		VITE FILETTATA THREADED SCREW TORNILLO ROSCADO		PROLUNGA A MANICOTTO THREADED EXTENSION EXTENSIÓN CON MANGUITO		TESTA FISSA FIXED HEAD CABEZA FIJA	
	da mm. from mm. de mm.	a mm. to mm. a mm.	Ø mm.	h. mm.	Ø mm.	h. mm.	pezzi n. pieces n. cant. piezas	h. mm.	Ø mm.	h. mm.
185FH	40	56	210	30	101.8	26			130	10
185.1FH	50	70	210	40	101.8	36			130	10
185.2FH	70	110	210	60	101.8	56			130	10
185.3FH	110	160	220	90	101.8	86			130	10
185.4FH	150	210	220	90	101.8	136			130	10
185.5FH	200	300	220	90	101.8	136	1	130	130	10
185.6FH	300	400	220	90	101.8	136	2	130	130	10
185.7FH	400	500	220	90	101.8	136	3	130	130	10
185.8FH	500	600	220	90	101.8	136	4	130	130	10
185.9FH	600	700	220	90	101.8	136	5	130	130	10
185.10FH	700	800	220	90	101.8	136	6	130	130	10
185.11FH	800	900	220	90	101.8	136	7	130	130	10
185.12FH	900	1.000	220	90	101.8	136	8	130	130	10

Per garantire la portata e la perfetta efficienza del sistema di regolazione, si raccomanda di non oltrepassare la misura massima dichiarata nella descrizione del prodotto.

In order to guarantee the perfect efficiency of the regulation system, it is highly recommended not to exceed the maximum height indicated in the product description.

Para garantizar la capacidad de carga y la perfecta eficiencia del sistema de regulación, se recomienda no superar la medida máxima indicada en la descripción del producto.

ARTICOLI OPZIONALI SPECIAL FH

OPTIONAL ITEMS SPECIAL FH

ARTÍCULOS OPCIONALES SPECIAL FH

Art. 186.3

DISTANZIALI PERIMETRALI - PERIMETRAL SPACER - DILATADORES PERIMETRALES

Inseriti direttamente nella testa autolivellante hanno uno spessore minimo di 4 mm. e permettono di tenere distanziata la pavimentazione dal perimetro di contenimento. Questo accorgimento annulla lo sfregamento della pavimentazione sulla membrana impermeabilizzante ove sia applicata con risvolto nella parete verticale ed evita l'accumulo di sporcizia, la quale potrebbe limitare l'evacuazione delle precipitazioni meteoriche. Tale misura di 4 mm. può essere moltiplicata essendo i distanziali impilabili.

Inserted directly into the self-leveling head they have a minimum thickness of 4 mm. and keep the flooring at a distance from the external perimeter; this prevents the flooring from rubbing against the waterproofing membrane where it is applied with a folded edge against the vertical wall, and prevents the accumulation of dirt, which might impede the drainage of rainwater. Since the spacers can be stacked, the thickness of 4 mm. can also be multiplied.

Colocados directamente en la cabeza autonivelante, tienen un espesor mínimo de 4 mm y permiten mantener separado el suelo del perímetro de contención. Esta solución cancela el roce del suelo sobre la membrana impermeabilizante cuando esté aplicada con una solapa en la pared vertical y evita la acumulación de suciedad, lo que podría limitar la evacuación del agua de lluvia. Dicha medida de 4 mm se puede aumentar porque los dilatadores son apilables.



Art. 186.4

PROLUNGA A MANICOTTO - SLEEVE EXTENSION - EXTENSIÓN CON MANGUITO

La prolunga manicotto è applicabile solo su Art. 185.4FH e consente di raggiungere altezze fino ad 1 metro e oltre, mantenendo un range di regolazione finale di 100 mm.

The sleeve extension is applicable on Art. 185.4FH and allows to reach heights up to 1 metre and above, maintaining a final adjustment of 100 mm.

La extensión con manguito solo se aplica en el Art. 185.4FH y permite alcanzar alturas de hasta 1 metro y más, manteniendo un rango de regulación final de 100 mm.



Art. 185HS

SILENZIATORE TESTA ANTISDRUCCIOLO - NON-SLIP HEAD SILENCER - ALMOHADILLA CABEZA ANTIDESLIZANTE

I silenziatori per teste prodotti in gomma fonoassorbente e antisdrucciolo sono studiati per abbattere il rumore derivante dal calpestio presente nelle pavimentazioni sopraelevate, inoltre fungono anche da antisdrucciolo per la pavimentazione installata. Vengono installati direttamente sulla parte superiore della testa e non necessitano di essere fissati.

The silencers for heads produced in sound-absorbing and non-slip rubber are designed to reduce the noise deriving from the trampling present in the raised floors, and also act as non-skid for the installed flooring. They are installed directly on the top of the head and they do not need to be fixed.

Las almohadillas para cabezas producidas en caucho insonorizante y antideslizante están diseñadas para reducir el ruido provocado por las pisadas en los suelos elevados y también actúan como antideslizante para el suelo instalado. Se instalan directamente en la parte superior de la cabeza y no necesitan ser fijadas.



Art. 186.6

CHIAVE DI REGOLAZIONE ITALPROFILI 50 CM ITALPROFILI REGULATING KEY 50 CM LLAVE DE REGULACIÓN ITALPROFILI 50 CM

Chiave di regolazione l. 500 mm., utilizzabile a pavimentazione ultimata con fughe 4 - 6 - 8 - 10 mm.

Regulating key l. 500 mm., used for paving completed with 4 - 6 - 8 - 10 mm spacers.

Llave de regulación de 500 mm. de largo, que se utiliza con el suelo terminado con juntas de 4 - 6 - 8 - 10 mm.



Art. 186.6 C

CHIAVE DI REGOLAZIONE ITALPROFILI 25 CM ITALPROFILI REGULATING KEY 25 CM LLAVE DE REGULACIÓN ITALPROFILI 25 CM

Chiave di regolazione l. 250 mm., utilizzabile a pavimentazione ultimata con fughe 4 - 6 - 8 - 10 mm.

Regulating key l. 250 mm., used for paving completed with 4 - 6 - 8 - 10 mm spacers.

Llave de regulación de 250 mm. de largo, que se utiliza con el suelo terminado con juntas de 4 - 6 - 8 - 10 mm.



Art. 186.5

SPESSORE LIVELLANTE - LEVELING SPACER - ESPESOR NIVELANTE

Lo spessore livellante da 1,5 a 5 mm. può essere usato interamente, è impilabile o sezionabile per 1/2 o 1/4. Viene impiegato nei casi in cui la superficie di appoggio sia molto irregolare o per colmare i dislivelli creati dai sormonti del manto impermeabile. Può essere utilizzato anche per aumentare l'altezza finale del basamento di 5 mm.

The leveling spacer, from 1,5 to 5 mm. , can be used as a whole, and can also be stacked or sectioned by 1/2 or 1/4. These components are used when the support surface is extremely irregular or to compensate for the differences in level created by overlaps in the waterproofing layer. It can also be used to increase the final height with 5 mm.

El espesor nivelante de 1,5 a 5 mm se puede utilizar por completo, apilar o cortar por 1/2 o 1/4. Se utiliza cuando la superficie de apoyo es muy irregular o para colmar los desniveles creados por el solapado de la membrana impermeable. También se puede utilizar para aumentar 5 mm la altura final del soporte.



Art. 185CV2 - 185CV4

SET CLIP CHIUSURA VERTICALI FUGA 2/4 mm - SET CLIP FOR VERTICAL CLOSURE SPACER 2/4 mm - JUEGO DE CERRAMIENTOS VERTICALES JUNTA 2/4 mm

I set clip chiusura verticali Italprofili sono studiati per dare un aggancio robusto ed esteticamente gradevole alle chiusure dei bordi perimetrali verticali nelle pavimentazioni sopraelevate, creando così un contenimento perimetrale per la pavimentazione. Realizzate in acciaio inox spessore 0,8 mm. sono disponibili con fuga 2 o 4 mm.

The Italprofili set clip for vertical closure is designed to give a strong and aesthetically pleasing attachment to the closing of the vertical perimeter edges in raised floors, thus creating a perimeter containment for the flooring. Made of 0,8 mm thick stainless steel, they are available with 2 or 4 mm spacers.

Los juegos de cerramientos verticales Italprofili están diseñados para un enganche fuerte y estéticamente agradable en los remates de los bordes perimetrales verticales en los suelos elevados, creando así una contención perimetral para el pavimento. Hechos de acero inoxidable de 0,8 mm de espesor, están disponibles con juntas de 2 o 4 mm.

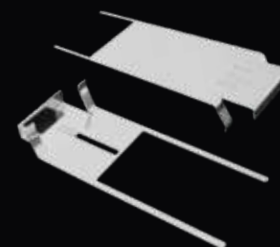

Art. 185DP2 - 185DP4

DISTANZIALE PERIMETRALE INOX FUGA 2/4 mm - PERIMETRAL SPACER STAINLESS STEEL FOR HEAD SPACER 2/4 mm - DILATADOR PERIMETRAL ACERO INOX JUNTA 2/4 mm

Il distanziale perimetrale viene posato direttamente sopra la testa permettendo di tenere distanziata di 5 mm. la pavimentazione dal perimetro verticale di contenimento. Opportunamente sagomato per evitare lo sfregamento della pavimentazione sul perimetro verticale di contenimento ed assorbire eventuali movimenti e dilatazioni della pavimentazione. Realizzato in acciaio inox, spessore di 0,8 mm.

The perimetral spacer is laid directly on the head allowing to keep the flooring of a distance of 5 mm from the vertical containment perimeter. Suitably shaped to avoid the rubbing of the pavement on the vertical containment perimeter and to absorb any movement and expansion of the pavement. Made of stainless steel, 0,8 mm thick.

El dilatador perimetral se coloca directamente sobre la cabeza, permitiendo mantener el pavimento a 5 mm de distancia del perímetro vertical de contención. Tiene una forma adecuada para evitar que el pavimento frote sobre el perímetro vertical de contención y para absorber posibles movimientos y dilataciones del pavimento. Está hecho de acero inoxidable de 0,8 mm de espesor.



Art. 190

PINZA POSAPIASTRE PER PIASTRE DI LATO 30 - 35 - 40 - 45 - 50 CM PAVING SLAB HANDLER 30 - 35 - 40 - 45 - 50 CM PINZA ESPESORADA PARA LOSAS DE 30 - 35 - 40 - 45 - 50 CM DE LADO



Art. 195

VENTOSA ALZAPIASTRELLE 110KG SUCTION CUP TILE LIFTER 110KG VENTOSA SUBIDA BALDOSAS 110 KG



VOCE DI CAPITOLATO DEI BASAMENTI REGOLABILI SPECIAL FH DESCRIPTION FOR SPECIFICATION OF THE ADJUSTABLE SPECIAL FH PAVING SUPPORTS ESPECIFICACIONES TÉCNICAS DE LOS SOPORTES REGULABLES SPECIAL FH

BASAMENTI REGOLABILI SPECIAL FH

Fornitura e posa in opera di basamenti regolabili del tipo Italprofili linea Special FH in polipropilene, per la realizzazione di pavimentazioni sopraelevate da esterno con finitura ceramica.

Il basamento è composto da:

- Base filettata
- Vite filettata
- Testa Special fissa con fuga disponibile da 2,3,4,6,8, e 10 mm.

ADJUSTABLE SPECIAL FH PAVING SUPPORTS

Supply and installation of adjustable Special FH paving supports made of polypropylene, for the realisation of raised floors for exteriors with ceramic.

The support consists of:

- Threaded base
- Threaded screw
- Fixed head Special with spacer-tabs available in 2,3,4,6,8, and 10 mm.

SOPORTES REGULABLES SPECIAL FH

Suministro y puesta en obra de soportes regulables de tipo Italprofili línea Special FH de polipropileno, para la realización de suelos elevados de exterior con acabado cerámico.

La base se compone de:

- Base roscada
- Tornillo roscado
- Cabeza Special fija con junta disponible de 2,3,4,6,8 y 10 mm.

PAVIMENTAZIONI SOPRAELEVATE DA ESTERNO
 RAISED FLOORS FOR EXTERIORS
 SUELOS ELEVADOS PARA EXTERIORES

SPECIAL MF CON TESTA MULTIFUNZIONE

SPECIAL MF WITH MULTIFUNCTIONAL HEAD

SPECIAL MF CON CABEZA MULTIFUNCIÓN

BASAMENTO REGOLABILE
 ADJUSTABLE SPAVING UPPORT
 SOPORTE REGULABLE

- Art. 185MF 40 ÷ 56 mm
- Art. 185.1MF 50 ÷ 70 mm
- Art. 185.2MF 70 ÷ 110 mm
- Art. 185.3MF 110 ÷ 160 mm
- Art. 185.4MF 150 ÷ 210 mm
- Art. 185.5MF 200 ÷ 300 mm
- Art. 185.6MF 300 ÷ 400 mm
- Art. 185.7MF 400 ÷ 500 mm
- Art. 185.8MF 500 ÷ 600 mm
- Art. 185.9MF 600 ÷ 700 mm
- Art. 185.10MF 700 ÷ 800 mm
- Art. 185.11MF 800 ÷ 900 mm
- Art. 185.12MF 900 ÷ 1.000 mm

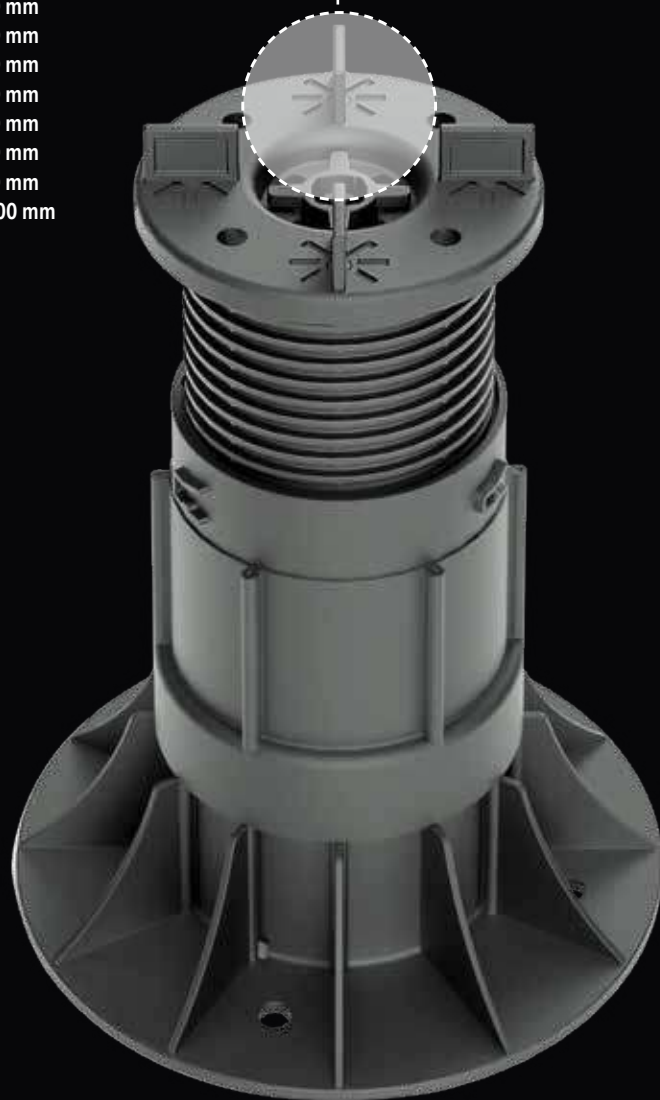

4 mm - h 10 mm
 ALETTE FUGA - THICK SPACERS - ALETAS JUNTA



4 mm - h 20 mm
 ALETTE FUGA - THICK SPACERS - ALETAS JUNTA

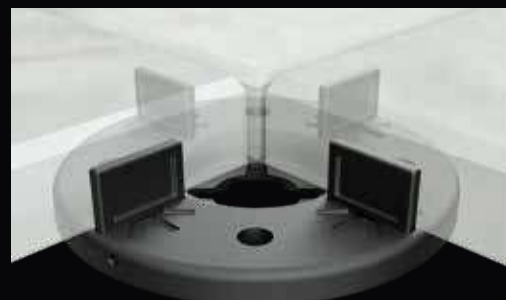

ESEMPIO DI POSA PER PAVIMENTAZIONE CERAMICA
 EXAMPLE OF LAYING FOR CERAMIC FLOORINGS
 EJEMPLO DE COLOCACIÓN PARA SUELOS DE CERÁMICA

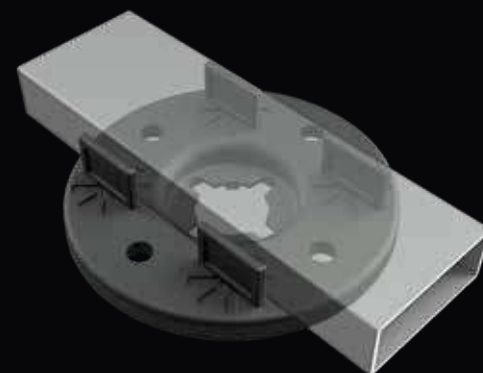

ESEMPIO DI POSA PER PAVIMENTAZIONE DECKING
 CON SOTTOSTRUTTURA A TRAVETTO (LARGHEZZA MAX 60 MM)
 EXAMPLE OF LAYING FOR DECKING SYSTEMS WITH JOIST
 SUPPORT STRUCTURE (WIDTH MAX. 60 MM)
 EJEMPLO DE COLOCACIÓN PARA SUELOS DE TARIMA
 CON ESTRUCTURA INFERIOR CON TRAVESAÑOS
 (ANCHO MÁX. 60 MM)



TESTA MULTIFUNZIONE / MULTIFUNCTIONAL HEAD / CABEZA MULTIFUNCIÓN

La testa multifunzione autolivellante è stata progettata per essere utilizzata con qualsiasi tipo di pavimentazioni sopraelevate ceramiche, cementizie o decking con sottostruttura a travetto grazie alle sue alette orientabili. Autolivellante fino ad una pendenza massima del 9%+ con alette distanziali spessore 4mm. Altezza 10 o 20 mm. Nel caso si necessiti della testa fissa è possibile utilizzare l'anello blocca testa Art. 186.2.

The multifunctional self-leveling head has been designed to be used with any type of raised, ceramic, cementitious or decking floors with joist support structure thanks to its adjustable spacers. Self-leveling up to a maximum of 9%+ with 4 mm thick. Height 10 or 20 mm. If the fixed head is needed, it is possible to use the locking ring art. 186.2.

La cabeza multifunción autonivelante ha sido diseñada para ser utilizada en cualquier tipo de suelo elevado de cerámica, cemento o de tarima con una estructura inferior con travesaños gracias a sus aletas orientables. Es autonivelante hasta una pendiente máxima de 9%+ con aletas distanciadoras de 4 mm de espesor. Altura 10 o 20 mm. Si se necesitara la cabeza fija, es posible utilizar el anillo de bloqueo de la cabeza Art. 186.2.

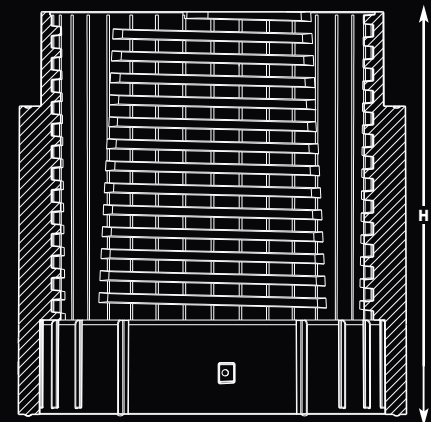
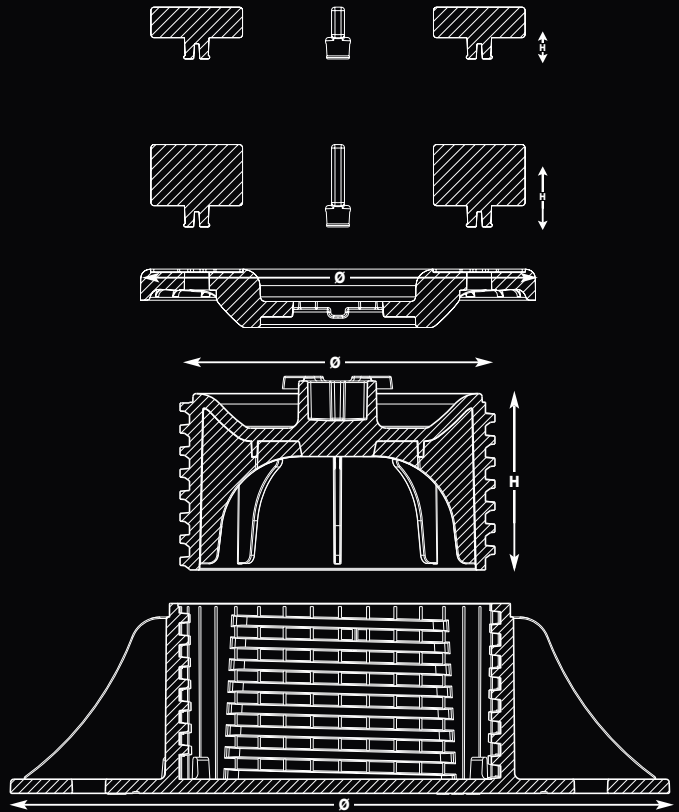

COMPOSIZIONE BASAMENTI REGOLABILI SPECIAL MF / COMPOSITION OF ADJUSTABLE SUPPORTS SPECIAL MF / COMPOSICIÓN SOPORTES REGULABLES SPECIAL MF

ARTICOLO CODE ART ARTÍCULO	MISURE SIZE MEDIDAS		BASE BASE BASE		VITE FILETTATA THREADED SCREW TORNILLO ROSCADO		PROLUNGA A MANICOTTO THREADED EXTENSION EXTENSIÓN CON MANGUITO		TESTA MULTIFUNZIONE MULTIFUNCTIONAL HEAD CABEZA MULTIFUNCIÓN		
	da mm. from mm. de mm.	a mm. to mm. a mm.	Ø mm.	h. mm.	Ø mm.	h. mm.	pezzi n. pieces n. cant. piezas	h. mm.	Ø mm.	h. mm.	livellamento max % max slope % nivelación máx. %
185MF	40	56	210	30	101.8	26			130	10/20	± 9
185.1MF	50	70	210	40	101.8	36			130	10/20	± 9
185.2MF	70	110	210	60	101.8	56			130	10/20	± 9
185.3MF	110	160	220	90	101.8	86			130	10/20	± 9
185.4MF	150	210	220	90	101.8	136			130	10/20	± 9
185.5MF	200	300	220	90	101.8	136	1	130	130	10/20	± 9
185.6MF	300	400	220	90	101.8	136	2	130	130	10/20	± 9
185.7MF	400	500	220	90	101.8	136	3	130	130	10/20	± 9
185.8MF	500	600	220	90	101.8	136	4	130	130	10/20	± 9
185.9MF	600	700	220	90	101.8	136	5	130	130	10/20	± 9
185.10MF	700	800	220	90	101.8	136	6	130	130	10/20	± 9
185.11MF	800	900	220	90	101.8	136	7	130	130	10/20	± 9
185.12MF	900	1.000	220	90	101.8	136	8	130	130	10/20	± 9

Per garantire la portata e la perfetta efficienza del sistema di regolazione, si raccomanda di non oltrepassare la misura massima dichiarata nella descrizione del prodotto.

In order to guarantee the perfect efficiency of the regulation system, it is highly recommended not to exceed the maximum height indicated in the product description.

Para garantizar la capacidad de carga y la perfecta eficiencia del sistema de regulación, se recomienda no superar la medida máxima indicada en la descripción del producto.

ARTICOLI OPZIONALI SPECIAL MF

OPTIONAL ITEMS SPECIAL MF

ARTÍCULOS OPCIONALES SPECIAL MF

Art. 186.3

DISTANZIALI PERIMETRALI - PERIMETRAL SPACER - DILATADORES PERIMETRALES

Inseriti direttamente nella testa autolivellante hanno uno spessore minimo di 4 mm. e permettono di tenere distanziata la pavimentazione dal perimetro di contenimento. Questo accorgimento annulla lo sfregamento della pavimentazione sulla membrana impermeabilizzante ove sia applicata con risvolto nella parete verticale ed evita l'accumulo di sporcizia, la quale potrebbe limitare l'evacuazione delle precipitazioni meteoriche. Tale misura di 4 mm. può essere moltiplicata essendo i distanziali impilabili.

Inserted directly into the self-leveling head they have a minimum thickness of 4 mm. and keep the flooring at a distance from the external perimeter; this prevents the flooring from rubbing against the waterproofing membrane where it is applied with a folded edge against the vertical wall, and prevents the accumulation of dirt, which might impede the drainage of rainwater. Since the spacers can be stacked, the thickness of 4 mm. can also be multiplied.

Colocados directamente en la cabeza autonivelante, tienen un espesor mínimo de 4 mm y permiten mantener separado el suelo del perímetro de contención. Esta solución cancela el roce del suelo sobre la membrana impermeabilizante cuando esté aplicada con una solapa en la pared vertical y evita la acumulación de suciedad, lo que podría limitar la evacuación del agua de lluvia. Dicha medida de 4 mm se puede aumentar porque los dilatadores son apilables.



Art. 186.4

PROLUNGA A MANICOTTO - SLEEVE EXTENSION - EXTENSIÓN CON MANGUITO

La prolunga manicotto è applicabile solo su Art. 185.4MF e consente di raggiungere altezze fino ad 1 metro e oltre, mantenendo un range di regolazione finale di 100 mm.

The sleeve extension is applicable on Art. 185.4MF and allows to reach heights up to 1 metre and above, maintaining a final adjustment of 100 mm.

La extensión con manguito solo se aplica en el Art. 185.4MF y permite alcanzar alturas de hasta 1 metro y más, manteniendo un rango de regulación final de 100 mm.



Art. 186.2

ANELLO BLOCCA TESTA - HEAD LOCKING RING - ANILLO DE BLOQUEO DE LA CABEZA

L'anello bloccatesta permette di rendere fissa la testa autolivellante MF.

The head locking ring allows to make the self-leveling head MF fixed.

El anillo de bloqueo de la cabeza permite que la cabeza autonivelante MF quede fija.



Art. 186.6

CHIAVE DI REGOLAZIONE ITALPROFILI 50 CM ITALPROFILI REGULATING KEY 50 CM LLAVE DE REGULACIÓN ITALPROFILI 50 CM

Chiave di regolazione l. 500 mm., utilizzabile a pavimentazione ultimata con fughe 4 - 6 - 8 - 10 mm.

Regulating key l. 500 mm., used for paving completed with 4 - 6 - 8 - 10 mm spacers.

Llave de regulación de 500 mm. de largo, que se utiliza con el suelo terminado con juntas de 4 - 6 - 8 - 10 mm.



Art. 186.6 C

CHIAVE DI REGOLAZIONE ITALPROFILI 25 CM ITALPROFILI REGULATING KEY 25 CM LLAVE DE REGULACIÓN ITALPROFILI 25 CM

Chiave di regolazione l. 250 mm., utilizzabile a pavimentazione ultimata con fughe 4 - 6 - 8 - 10 mm.

Regulating key l. 250 mm., used for paving completed with 4 - 6 - 8 - 10 mm spacers.

Llave de regulación de 250 mm. de largo, que se utiliza con el suelo terminado con juntas de 4 - 6 - 8 - 10 mm.



Art. 186.5

SPESSORE LIVELLANTE - LEVELING SPACER - ESPESOR NIVELANTE

Lo spessore livellante da 1,5 a 5 mm. può essere usato interamente, è impilabile o sezionabile per 1/2 o 1/4. Viene impiegato nei casi in cui la superficie di appoggio sia molto irregolare o per colmare i dislivelli creati dai sormonti del manto impermeabile. Può essere utilizzato anche per aumentare l'altezza finale del basamento di 5 mm.

The leveling spacer, from 1,5 to 5 mm. , can be used as a whole, and can also be stacked or sectioned by 1/2 or 1/4. These components are used when the support surface is extremely irregular or to compensate for the differences in level created by overlaps in the waterproofing layer. It can also be used to increase the final height with 5 mm.

El espesor nivelante de 1,5 a 5 mm se puede utilizar por completo, apilar o cortar por 1/2 o 1/4. Se utiliza cuando la superficie de apoyo es muy irregular o para colmar los desniveles creados por el solapado de la membrana impermeable. También se puede utilizar para aumentar 5 mm la altura final del soporte.



Art. 185CV2 - 185CV4

SET CLIP CHIUSURA VERTICALI FUGA 2/4 mm - SET CLIP FOR VERTICAL CLOSURE SPACER 2/4 mm - JUEGO DE CERRAMIENTOS VERTICALES JUNTA 2/4 mm

I set clip chiusura verticali Italprofili sono studiati per dare un aggancio robusto ed esteticamente gradevole alle chiusure dei bordi perimetrali verticali nelle pavimentazioni sopraelevate, creando così un contenimento perimetrale per la pavimentazione. Realizzate in acciaio inox spessore 0,8 mm. sono disponibili con fuga 2 o 4 mm.

The Italprofili set clip for vertical closure is designed to give a strong and aesthetically pleasing attachment to the closing of the vertical perimeter edges in raised floors, thus creating a perimeter containment for the flooring. Made of 0,8 mm thick stainless steel, they are available with 2 or 4 mm spacers.

Los juegos de cerramientos verticales Italprofili están diseñados para un enganche fuerte y estéticamente agradable en los remates de los bordes perimetrales verticales en los suelos elevados, creando así una contención perimetral para el pavimento. Hechos de acero inoxidable de 0,8 mm de espesor, están disponibles con juntas de 2 o 4 mm.

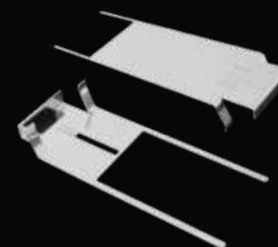

Art. 185DP2 - 185DP4

DISTANZIALE PERIMETRALE INOX FUGA 2/4 mm - PERIMETRAL SPACER STAINLESS STEEL FOR HEAD SPACER 2/4 mm - DILATADOR PERIMETRAL ACERO INOX JUNTA 2/4 mm

Il distanziale perimetrale viene posato direttamente sopra la testa permettendo di tenere distanziata di 5 mm. la pavimentazione dal perimetro verticale di contenimento. Opportunamente sagomato per evitare lo sfregamento della pavimentazione sul perimetro verticale di contenimento ed assorbire eventuali movimenti e dilatazioni della pavimentazione. Realizzato in acciaio inox, spessore di 0,8 mm.

The perimetral spacer is laid directly on the head allowing to keep the flooring of a distance of 5 mm from the vertical containment perimeter. Suitably shaped to avoid the rubbing of the pavement on the vertical containment perimeter and to absorb any movement and expansion of the pavement. Made of stainless steel, 0,8 mm thick.

El dilatador perimetral se coloca directamente sobre la cabeza, permitiendo mantener el pavimento a 5 mm de distancia del perímetro vertical de contención. Tiene una forma adecuada para evitar que el pavimento frote sobre el perímetro vertical de contención y para absorber posibles movimientos y dilataciones del pavimento. Está hecho de acero inoxidable de 0,8 mm de espesor.



Art. 190

PINZA POSAPIASTRE PER PIASTRE DI LATO 30 - 35 - 40 - 45 - 50 CM PAVING SLAB HANDLER 30 - 35 - 40 - 45 - 50 CM PINZA ESPESORADA PARA LOSAS DE 30 - 35 - 40 - 45 - 50 CM DE LADO



Art. 195

VENTOSA ALZAPIASTRELLE 110KG SUCTION CUP TILE LIFTER 110KG VENTOSA SUBIDA BALDOSAS 110 KG



VOCE DI CAPITOLATO DEI BASAMENTI REGOLABILI SPECIAL MF DESCRIPTION FOR SPECIFICATION OF THE ADJUSTABLE SPECIAL MF PAVING SUPPORTS ESPECIFICACIONES TÉCNICAS DE LOS SOPORTES REGULABLES SPECIAL MF

BASAMENTI REGOLABILI SPECIAL MF

Fornitura e posa in opera di basamenti regolabili del tipo Italprofili linea Special MF in polipropilene, per la realizzazione di pavimentazioni sopraelevate da esterno con finitura ceramica, decking o legno.

Il basamento è composto da:

- Base filettata
- Vite filettata
- Testa autolivellante multifunzione Special con fuga da 4 mm. h 10 o 20 mm.

ADJUSTABLE SPECIAL MF PAVING SUPPORTS

Supply and installation of adjustable Special MF paving supports made of polypropylene, for the realisation of raised floors for exteriors with ceramic, decking or wood.

The support consists of:

- Threaded base
- Threaded screw
- Self-levelling multifunctional head Special with spacer-tabs 4 mm. h. 10 or 20 mm.

SOPORTES REGULABLES SPECIAL MF

Suministro y puesta en obra de soportes regulables de tipo Italprofili línea Special MF de polipropileno, para la realización de suelos elevados de exterior con acabado cerámico, de tarima o madera.

La base se compone de:

- Base roscada
- Tornillo roscado
- Cabeza autonivelante multifunción Special con junta de 4 mm. h 10 o 20 mm.

SPECIAL JOIST CON TESTA AUTOLIVELLANTE

SPECIAL JOIST WITH SELF-LEVELING HEAD

SPECIAL JOIST CON CABEZA AUTONIVELANTE

**BASAMENTO REGOLABILE
ADJUSTABLE PAVING SUPPORT
SOPORTE REGULABLE**

Art.	185J	40 ÷ 56 mm
Art.	185.1J	50 ÷ 70 mm
Art.	185.2J	70 ÷ 110 mm
Art.	185.3J	110 ÷ 160 mm
Art.	185.4J	150 ÷ 210 mm
Art.	185.5J	200 ÷ 300 mm
Art.	185.6J	300 ÷ 400 mm
Art.	185.7J	400 ÷ 500 mm
Art.	185.8J	500 ÷ 600 mm
Art.	185.9J	600 ÷ 700 mm
Art.	185.10J	700 ÷ 800 mm
Art.	185.11J	800 ÷ 900 mm
Art.	185.12J	900 ÷ 1.000 mm

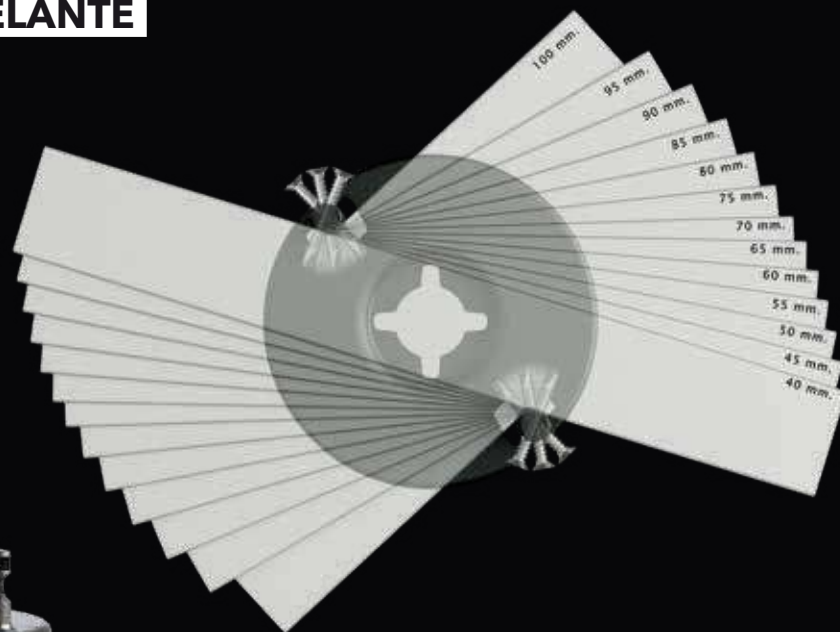

TESTA AUTOLIVELLANTE / SELF-LEVELING HEAD / CABEZA AUTONIVELANTE

La testa Special Joist autolivellante per pavimentazioni decking con sottostruttura a travetto è stata progettata appositamente per permettere l'installazione di travetti da 40 a 100mm. L'innovativo sistema permette di mantenere il travetto sempre centrato nella testa distribuendo in modo uniforme il carico. Il fissaggio del travetto avviene lateralmente negli appositi fori con viti autofilettanti.

The Special Joist self-leveling head for decking floors with joist support structure has been specifically designed to allow the installation of joists from 40 to 100 mm. The innovative system allows to keep the joist always centered in the head, distributing the load evenly. The joist is fixed sideways in the appropriate holes with self-tapping screws.

La cabeza Special Joist autonivelante para suelos de tarima con estructura inferior con travesaños ha sido diseñada específicamente para permitir la instalación de travesaños de 40 a 100 mm. El innovador sistema permite mantener el travesaño siempre centrado en la cabeza, distribuyendo la carga de manera uniforme. El travesaño se fija lateralmente con tornillos autorroscantes en los orificios específicos.

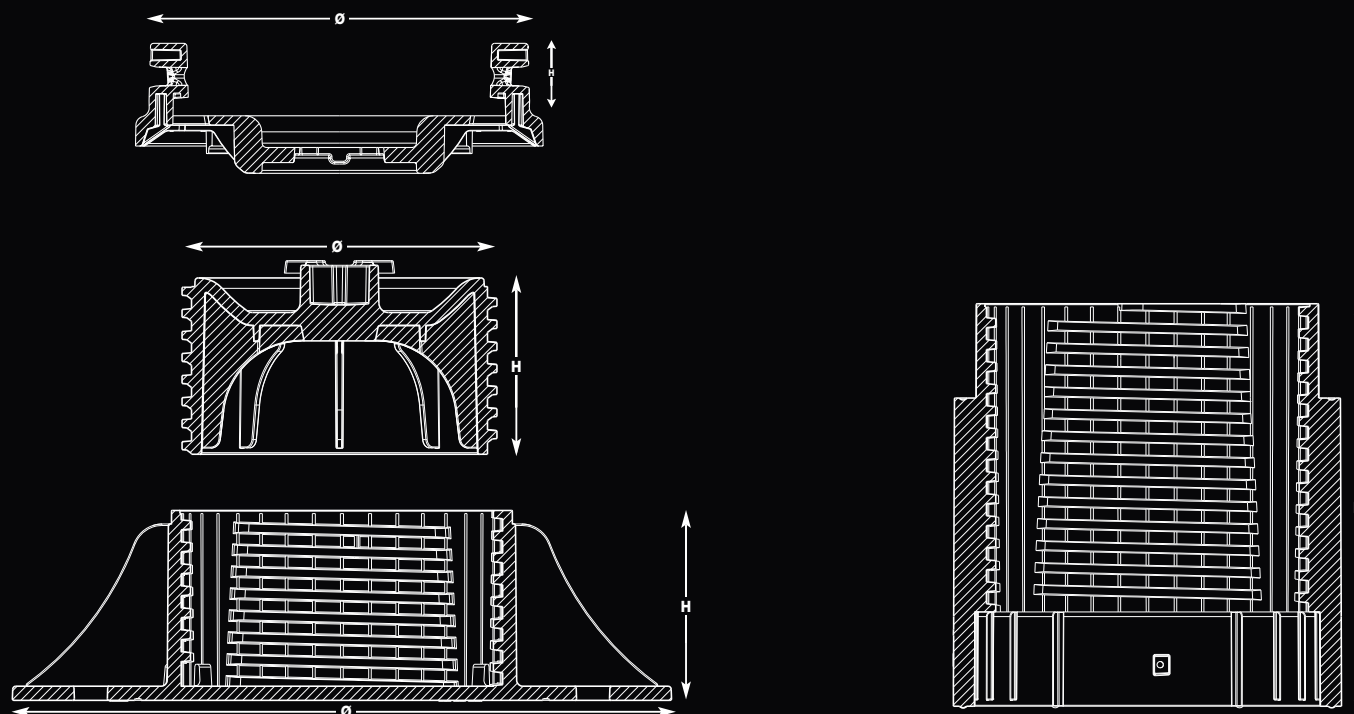

COMPOSIZIONE BASAMENTI REGOLABILI SPECIAL JOIST / COMPOSITION OF ADJUSTABLE SUPPORTS SPECIAL JOIST / COMPOSICIÓN SOPORTES REGULABLES SPECIAL JOIST

ARTICOLO CODE ART ARTÍCULO	MISURE SIZE MEDIDAS		BASE BASE BASE		VITE FILETTATA THREADED SCREW TORNILLO ROSCADO		PROLUNGA A MANICOTTO THREADED EXTENSION EXTENSIÓN CON MANGUITO		TESTA AUTOLIVELLANTE da 40 a 100 mm. SELF-LEVELING HEAD from 40 to 100 mm. CABEZA AUTONIVELANTE de 40 a 100 mm.		
	codice code código	da mm. from mm. de mm.	a mm. to mm. a mm.	Ø mm.	h. mm.	Ø mm.	h. mm.	pezzi n. pieces n. cant. piezas	h. mm.	Ø mm.	h. mm.
185J	40	56	210	30	101.8	26			133	24	± 9
185.1J	50	70	210	40	101.8	36			133	24	± 9
185.2J	70	110	210	60	101.8	56			133	24	± 9
185.3J	110	160	220	90	101.8	86			133	24	± 9
185.4J	150	210	220	90	101.8	136			133	24	± 9
185.5J	200	300	220	90	101.8	136	1	130	133	24	± 9
185.6J	300	400	220	90	101.8	136	2	130	133	24	± 9
185.7J	400	500	220	90	101.8	136	3	130	133	24	± 9
185.8J	500	600	220	90	101.8	136	4	130	133	24	± 9
185.9J	600	700	220	90	101.8	136	5	130	133	24	± 9
185.10J	700	800	220	90	101.8	136	6	130	133	24	± 9
185.11J	800	900	220	90	101.8	136	7	130	133	24	± 9
185.12J	900	1.000	220	90	101.8	136	8	130	133	24	± 9

Per garantire la portata e la perfetta efficienza del sistema di regolazione, si raccomanda di non oltrepassare la misura massima dichiarata nella descrizione del prodotto.

In order to guarantee the perfect efficiency of the regulation system, it is highly recommended not to exceed the maximum height indicated in the product description.

Para garantizar la capacidad de carga y la perfecta eficiencia del sistema de regulación, se recomienda no superar la medida máxima indicada en la descripción del producto.

ARTICOLI OPZIONALI SPECIAL JOIST

OPTIONAL ITEMS SPECIAL JOIST

ARTÍCULOS OPCIONALES SPECIAL JOIST

Art. 186.6

**CHIAVE DI REGOLAZIONE ITALPROFILI 50 CM
ITALPROFILI REGULATING KEY 50 CM
LLAVE DE REGULACIÓN ITALPROFILI 50 CM**

Chiave di regolazione l. 500 mm., utilizzabile a pavimentazione ultimata con fughe 4 - 6 - 8 - 10 mm.

Regulating key l. 500 mm., used for paving completed with 4 - 6 - 8 - 10 mm spacers.

Llave de regulación de 500 mm. de largo, que se utiliza con el suelo terminado con juntas de 4 - 6 - 8 - 10 mm.

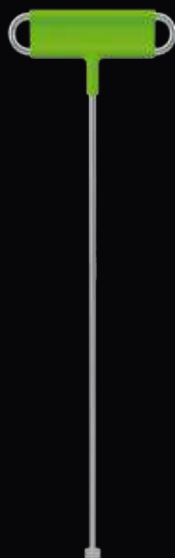

Art. 186.6 C

**CHIAVE DI REGOLAZIONE ITALPROFILI 25 CM
ITALPROFILI REGULATING KEY 25 CM
LLAVE DE REGULACIÓN ITALPROFILI 25 CM**

Chiave di regolazione l. 250 mm., utilizzabile a pavimentazione ultimata con fughe 4 - 6 - 8 - 10 mm.

Regulating key l. 250 mm., used for paving completed with 4 - 6 - 8 - 10 mm spacers.

Llave de regulación de 250 mm. de largo, que se utiliza con el suelo terminado con juntas de 4 - 6 - 8 - 10 mm.



Art. 186.4

PROLUNGA A MANICOTTO - SLEEVE EXTENSION - EXTENSIÓN CON MANGUITO

La prolunga manicotto è applicabile solo su Art. 185.4J e consente di raggiungere altezze fino ad 1 metro e oltre, mantenendo un range di regolazione finale di 100 mm.

The sleeve extension is applicable only on Art. 185.4J and allows to reach heights up to 1 metre and above, maintaining a final adjustment range of 100 mm.

La extensión con manguito solo se aplica en el Art. 185.4J y permite alcanzar alturas de hasta 1 metro y más, manteniendo un rango de regulación final de 100 mm.

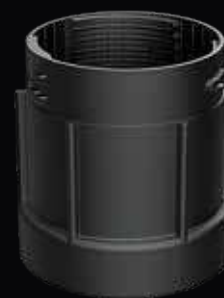

Art. 186.5

SPESSORE LIVELLANTE - LEVELING SPACER - ESPESOR NIVELANTE

Lo spessore livellante da 1,5 a 5 mm. può essere usato interamente, è impilabile o sezionabile per $\frac{1}{2}$ o $\frac{1}{4}$. Viene impiegato nei casi in cui la superficie di appoggio sia molto irregolare o per colmare i dislivelli creati dai sormonti del manto impermeabile. Può essere utilizzato anche per aumentare l'altezza finale del basamento di 5 mm.

The leveling spacer, from 1,5 to 5 mm., can be used as a whole, and can also be stacked or sectioned by $\frac{1}{2}$ or $\frac{1}{4}$. These components are used when the support surface is extremely irregular or to compensate for the differences in level created by overlaps in the waterproofing layer. It can also be used to increase the final height with 5 mm.

El espesor nivelante de 1,5 a 5 mm se puede utilizar por completo, apilar o cortar por $\frac{1}{2}$ o $\frac{1}{4}$. Se utiliza cuando la superficie de apoyo es muy irregular o para colmar los desniveles creados por el solapado de la membrana impermeable. También se puede utilizar para aumentar 5 mm la altura final del soporte.



VOCE DI CAPITOLATO DEI BASAMENTI REGOLABILI SPECIAL JOIST DESCRIPTION FOR SPECIFICATION OF THE ADJUSTABLE SPECIAL JOIST PAVING SUPPORTS ESPECIFICACIONES TÉCNICAS DE LOS SOPORTES REGULABLES SPECIAL JOIST

BASAMENTI REGOLABILI SPECIAL JOIST

Fornitura e posa in opera di basamenti regolabili del tipo Italprofili linea Special Joist in polipropilene, per la realizzazione di pavimentazioni sistema decking.

Il basamento è composto da:

- Base filettata
- Vite filettata
- Testa autolivellante Special Joist per travetti da 40 a 100 mm.

ADJUSTABLE SPECIAL JOIST PAVING SUPPORTS

Supply and installation of adjustable Special Joist paving supports made of polypropylene, for the realisation of raised floors for decking systems.

The support consists of:

- Threaded base
- Threaded screw
- Self-levelling head Special Joist for joists from 40 to 100 mm.

SOPORTES REGULABLES SPECIAL JOIST

Suministro y puesta en obra de soportes regulables de tipo Italprofili línea Special Joist de polipropileno, para la realización de pavimentos sistema de tarima.

La base se compone de:

- Base roscada
- Tornillo roscado
- Cabeza autonivelante Special Joist para vigas de 40 a 100 mm.

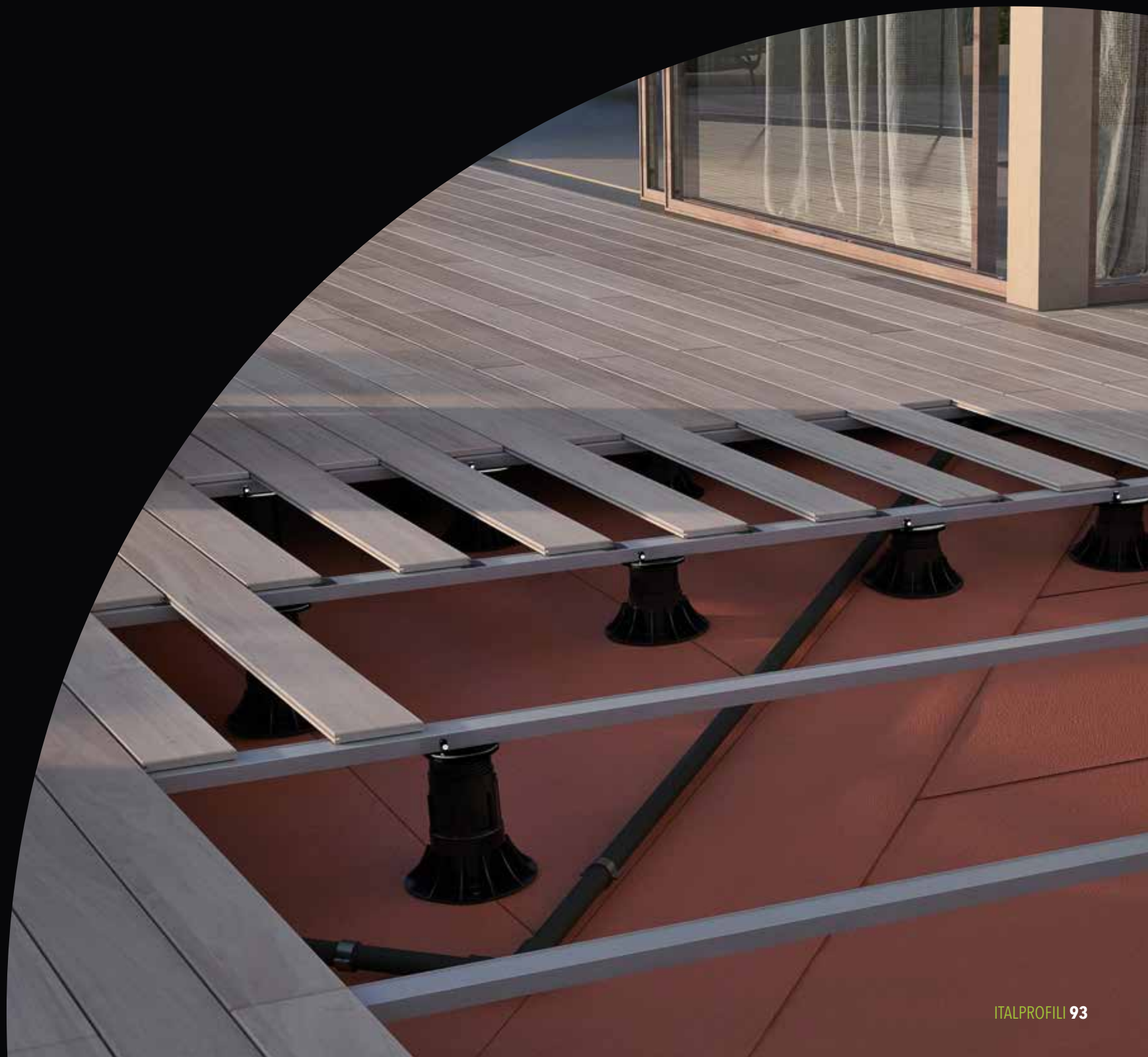

SPECIAL JOIST FH

CON TESTA FISSA

SPECIAL JOIST FH WITH FIXED HEAD

SPECIAL JOIST FH CON CABEZA FIJA

BASAMENTO REGOLABILE
ADJUSTABLE PAVING SUPPORT
SOPORTE REGULABLE

Art. 185JFH	40 ÷ 56 mm
Art. 185.1JFH	50 ÷ 70 mm
Art. 185.2JFH	70 ÷ 110 mm
Art. 185.3JFH	110 ÷ 160 mm
Art. 185.4JFH	150 ÷ 210 mm
Art. 185.5JFH	200 ÷ 300 mm
Art. 185.6JFH	300 ÷ 400 mm
Art. 185.7JFH	400 ÷ 500 mm
Art. 185.8JFH	500 ÷ 600 mm
Art. 185.9JFH	600 ÷ 700 mm
Art. 185.10JFH	700 ÷ 800 mm
Art. 185.11JFH	800 ÷ 900 mm
Art. 185.12JFH	900 ÷ 1.000 mm

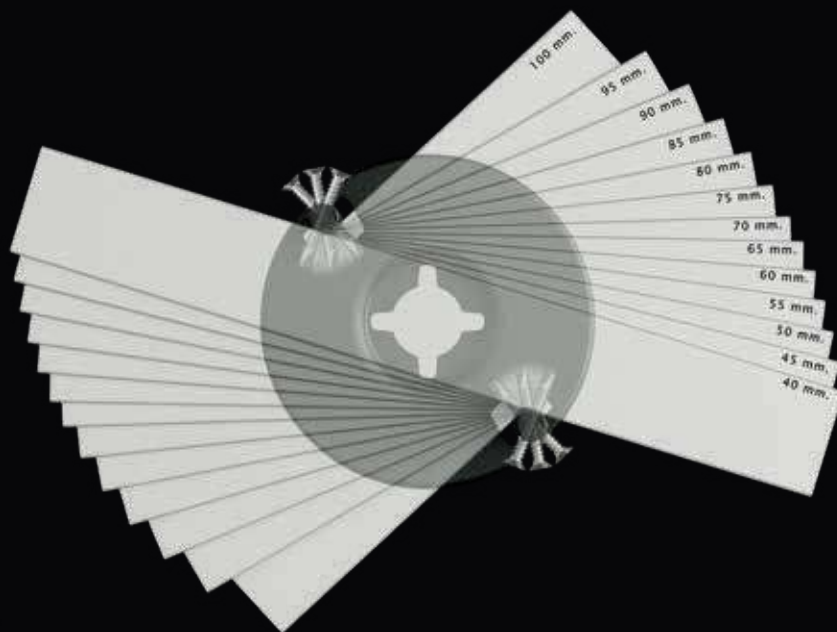

TESTA FISSA / FIXED HEAD / CABEZA FIJA

La testa Special Joist fissa per pavimentazioni decking con sottostruttura a travetto è stata progettata appositamente per permettere l'installazione di travetti da 40 a 100 mm. L'innovativo sistema permette di mantenere il travetto sempre centrato nella testa distribuendo in modo uniforme il carico. Il fissaggio del travetto avviene lateralmente negli appositi fori con viti autofilettanti.

The Special Joist fixed head for decking floors with joist support structure has been specifically designed to allow the installation of joists from 40 to 100 mm. The innovative system allows to keep the joist always centered in the head, distributing the load evenly. The joist is fixed sideways in the appropriate holes with self-tapping screws.

La cabeza Special Joist fija para suelos de tarima con estructura inferior con travesaños ha sido diseñada específicamente para permitir la instalación de travesaños de 40 a 100 mm. El innovador sistema permite mantener el travesaño siempre centrado en la cabeza, distribuyendo la carga de manera uniforme. El travesaño se fija lateralmente con tornillos autorroscantes en los orificios específicos.

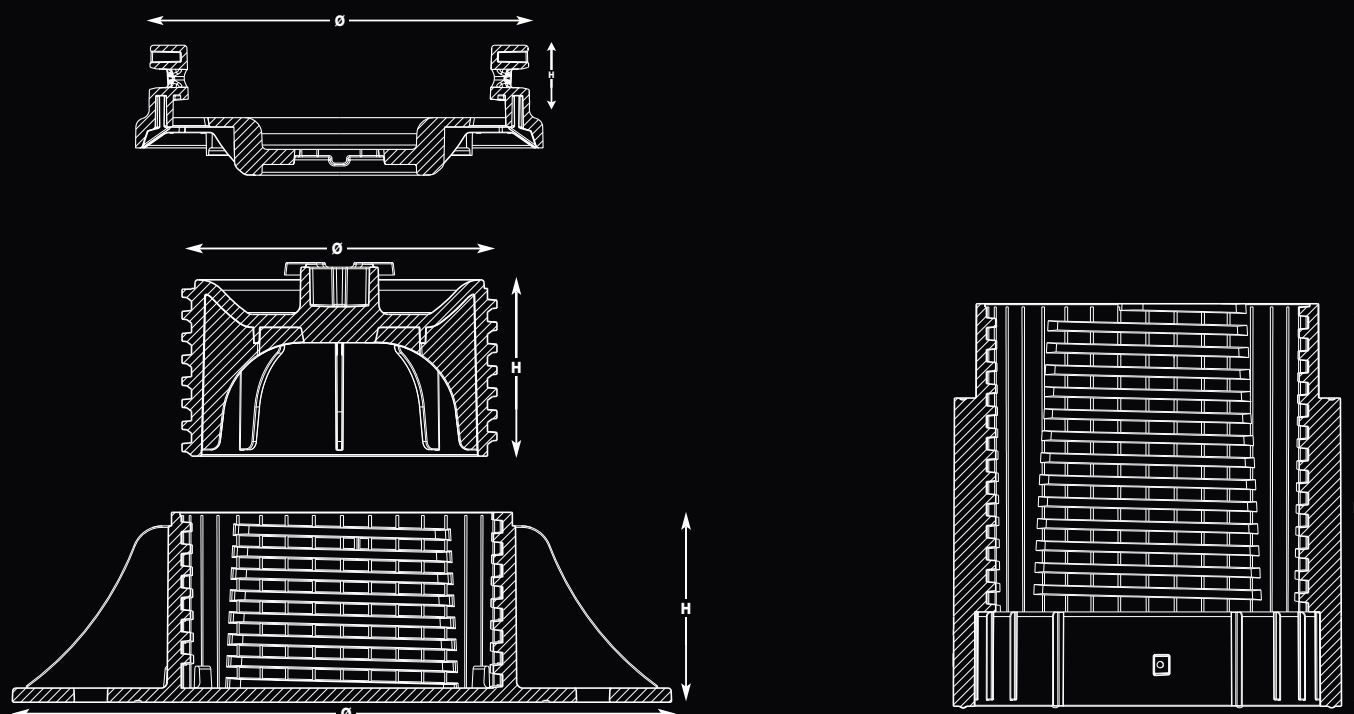

COMPOSIZIONE BASAMENTI REGOLABILI SPECIAL JOIST FH / COMPOSITION OF ADJUSTABLE SUPPORTS SPECIAL JOIST FH / COMPOSICIÓN SOPORTES REGULABLES SPECIAL JOIST FH

ARTICOLO CODE ART ARTÍCULO	MISURE SIZE MEDIDAS		BASE BASE BASE		VITE FILETTATA THREADED SCREW TORNILLO ROSCADO		PROLUNGA A MANICOTTO THREADED EXTENSION EXTENSIÓN CON MANGUITO		TESTA FISSA da 40 a 100 mm. FIXED HEAD from 40 to 100 mm. CABEZA FIJA de 40 a 100 mm.	
	da mm. from mm. de mm.	a mm. to mm. a mm.	Ø mm.	h. mm.	Ø mm.	h. mm.	pezzi n. pieces n. cant. piezas	h. mm.	Ø mm.	h. mm.
185JFH	40	56	210	30	101.8	26			133	24
185.1JFH	50	70	210	40	101.8	36			133	24
185.2JFH	70	110	210	60	101.8	56			133	24
185.3JFH	110	160	220	90	101.8	86			133	24
185.4JFH	150	210	220	90	101.8	136			133	24
185.5JFH	200	300	220	90	101.8	136	1	130	133	24
185.6JFH	300	400	220	90	101.8	136	2	130	133	24
185.7JFH	400	500	220	90	101.8	136	3	130	133	24
185.8JFH	500	600	220	90	101.8	136	4	130	133	24
185.9JFH	600	700	220	90	101.8	136	5	130	133	24
185.10JFH	700	800	220	90	101.8	136	6	130	133	24
185.11JFH	800	900	220	90	101.8	136	7	130	133	24
185.12JFH	900	1.000	220	90	101.8	136	8	130	133	24

Per garantire la portata e la perfetta efficienza del sistema di regolazione, si raccomanda di non oltrepassare la misura massima dichiarata nella descrizione del prodotto.

In order to guarantee the perfect efficiency of the regulation system, it is highly recommended not to exceed the maximum height indicated in the product description.

Para garantizar la capacidad de carga y la perfecta eficiencia del sistema de regulación, se recomienda no superar la medida máxima indicada en la descripción del producto.

ARTICOLI OPZIONALI SPECIAL JOIST FH

OPTIONAL ITEMS SPECIAL JOIST

ARTÍCULOS OPCIONALES SPECIAL JOIST FH

Art. 186.6

**CHIAVE DI REGOLAZIONE ITALPROFILI 50 CM
ITALPROFILI REGULATING KEY 50 CM
LLAVE DE REGULACIÓN ITALPROFILI 50 CM**

Chiave di regolazione l. 500 mm., utilizzabile a pavimentazione ultimata con fughe 4 - 6 - 8 - 10 mm.

Regulating key l. 500 mm., used for paving completed with 4 - 6 - 8 - 10 mm spacers.

Llave de regulación de 500 mm. de largo, que se utiliza con el suelo terminado con juntas de 4 - 6 - 8 - 10 mm.

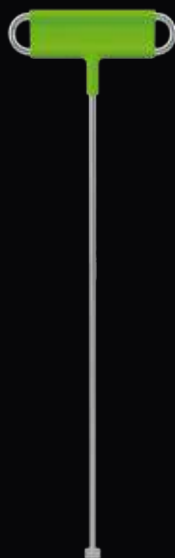

Art. 186.6 C

**CHIAVE DI REGOLAZIONE ITALPROFILI 25 CM
ITALPROFILI REGULATING KEY 25 CM
LLAVE DE REGULACIÓN ITALPROFILI 25 CM**

Chiave di regolazione l. 250 mm., utilizzabile a pavimentazione ultimata con fughe 4 - 6 - 8 - 10 mm.

Regulating key l. 250 mm., used for paving completed with 4 - 6 - 8 - 10 mm spacers.

Llave de regulación de 250 mm. de largo, que se utiliza con el suelo terminado con juntas de 4 - 6 - 8 - 10 mm.



Art. 186.4

PROLUNGA A MANICOTTO - SLEEVE EXTENSION - EXTENSIÓN CON MANGUITO

La prolunga manicotto è applicabile solo su Art. 185.4JFH e consente di raggiungere altezze fino ad 1 metro e oltre, mantenendo un range di regolazione finale di 100 mm.

The sleeve extension is applicable only on Art. 185.4JFH and allows to reach heights up to 1 metre and above, maintaining a final adjustment range of 100 mm.

La extensión con manguito solo se aplica en el Art. 185.4JFH y permite alcanzar alturas de hasta 1 metro y más, manteniendo un rango de regulación final de 100 mm.

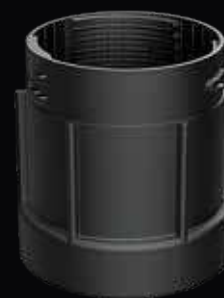

Art. 186.5

SPESSORE LIVELLANTE - LEVELING SPACER - ESPESOR NIVELANTE

Lo spessore livellante da 1,5 a 5 mm. può essere usato interamente, è impilabile o sezionabile per $\frac{1}{2}$ o $\frac{1}{4}$. Viene impiegato nei casi in cui la superficie di appoggio sia molto irregolare o per colmare i dislivelli creati dai sormonti del manto impermeabile. Può essere utilizzato anche per aumentare l'altezza finale del basamento di 5 mm.

The leveling spacer, from 1,5 to 5 mm., can be used as a whole, and can also be stacked or sectioned by $\frac{1}{2}$ or $\frac{1}{4}$. These components are used when the support surface is extremely irregular or to compensate for the differences in level created by overlaps in the waterproofing layer. It can also be used to increase the final height with 5 mm.

El espesor nivelante de 1,5 a 5 mm se puede utilizar por completo, apilar o cortar por $\frac{1}{2}$ o $\frac{1}{4}$. Se utiliza cuando la superficie de apoyo es muy irregular o para colmar los desniveles creados por el solapado de la membrana impermeable. También se puede utilizar para aumentar 5 mm la altura final del soporte.



VOCE DI CAPITOLATO DEI BASAMENTI REGOLABILI SPECIAL JOIST FH DESCRIPTION FOR SPECIFICATION OF THE ADJUSTABLE SPECIAL JOIST FH PAVING SUPPORTS ESPECIFICACIONES TÉCNICAS DE LOS SOPORTES REGULABLES SPECIAL JOIST FH

BASAMENTI REGOLABILI SPECIAL JOIST FH

Fornitura e posa in opera di basamenti regolabili del tipo Italprofili linea Special Joist FH in polipropilene, per la realizzazione di pavimentazioni sistema decking.

Il basamento è composto da:

- Base filettata
- Vite filettata
- Testa fissa Special Joist per travetti da 40 a 100 mm.

ADJUSTABLE SPECIAL JOIST FH PAVING SUPPORTS

Supply and installation of adjustable Special Joist FH paving supports made of polypropylene, for the realisation of raised floors for decking systems.

The support consists of:

- Threaded base
- Threaded screw
- Fixed head Special Joist for joists from 40 to 100 mm.

SOPORTES REGULABLES SPECIAL JOIST FH

Suministro y puesta en obra de soportes regulables de tipo Italprofili línea Special FH de polipropileno, para la realización de pavimentos sistema de tarima.

La base se compone de:

- Base roscada
- Tornillo roscado
- Cabeza fija Special Joist para vigas de 40 a 100 mm.



BASAMENTI REGOLABILI LINEA SPECIAL LIGHT



SPECIAL
LIGHT

ADJUSTABLE SUPPORT SYSTEMS SPECIAL LIGHT

SOPORTES REGULABLES LÍNEA SPECIAL LIGHT



**PORTATA CERTIFICATA DA 1100 A 1760 KG
CERTIFICATI DISPONIBILI A RICHIESTA**

**CERTIFIED LOAD CAPACITY FROM 1100 TO 1760 KG
CERTIFICATES AVAILABLE ON REQUEST**

**CAPACIDAD DE CARGA CERTIFICADA DE 1100 A 1760 KG
CERTIFICADOS DISPONIBLES A PETICIÓN**



SPECIAL LIGHT

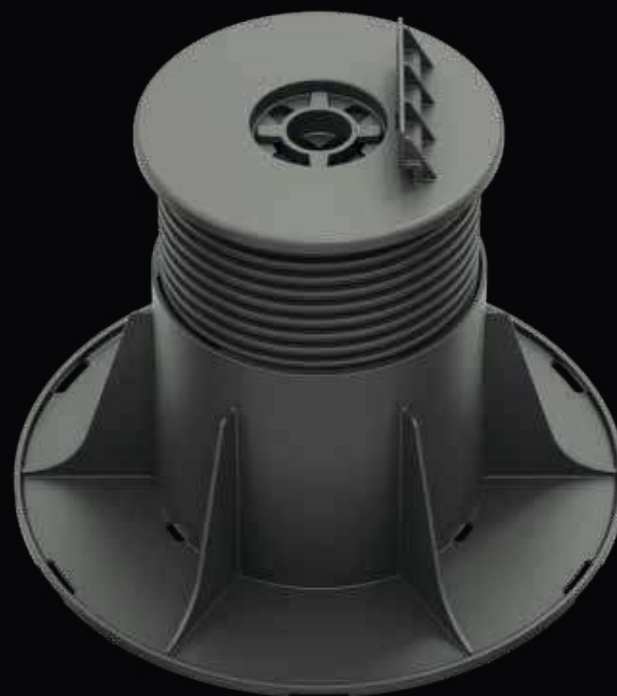

SPECIAL LIGHT JOIST

I BASAMENTI REGOLABILI della serie "SPECIAL LIGHT" per pavimentazioni sopraelevate possono essere impiegati esternamente con diverse tipologie di pavimentazioni quali piastre prefabbricate, piastrelle in gres porcellanato, marmo, pietra, legno, legno composito.

Vengono utilizzati come supporti al di sotto di una pavimentazione sopraelevata, per rendere praticabili zone impermeabilizzate e non, permettere il passaggio di cavi e tubazioni che sono di norma presenti in uffici, negozi ed ambienti di lavoro.

Per questo motivo le pavimentazioni sopraelevate sono utilizzate soprattutto nelle nuove costruzioni o negli interventi di ristrutturazione dove è richiesta massima flessibilità progettuale e facilità d'ispezione dell'impermeabilizzazione e degli impianti a terra.

Il materiale utilizzato per la realizzazione dei basamenti regolabili Special Light è polipropilene di prima scelta opportunamente additivato per garantire lunga durata nel tempo e aumentare la resistenza di portata.

The ADJUSTABLE PAVING SUPPORT "SPECIAL LIGHT" for raised floors can be used with a wide range of different types of pavings, for example porcelain, marble, stone, wood, composite wood.

It is the perfect solution for turning non practicable areas into practicable ones, whether they are waterproofed and not, it also allows for the passage of cables, pipes etc that are normally present in offices, shops and work environments.

For this reason, raised floors are mainly used in new buildings or in renovation where maximum design and flexibility is required or simply to ease the inspection of the waterproofing layer or any pipes, cables etc.

The adjustable paving support Special Light is produced using only the finest top grade polypropylene and additives, these top quality raw materials ensure its long durability and also increase the load capacity.

Los SOPORTES REGULABLES de la serie "SPECIAL LIGHT" para suelos elevados se pueden usar en exteriores con diferentes tipos de suelos, tales como losas prefabricadas, baldosas de gres porcelánico, mármol, piedra, madera y madera compuesta.

Se utilizan como soportes debajo de un suelo elevado, para volver practicable las zonas impermeabilizadas y otros tipos de zonas, permitir el paso de cables y tuberías que por lo general se encuentran en oficinas, tiendas y entornos de trabajo.

Por este motivo, los suelos elevados se utilizan sobre todo en las nuevas construcciones o en las obras de reestructuración donde se requiere la máxima flexibilidad de diseño y una fácil inspección de la impermeabilización y de las instalaciones que pasan por el suelo.

El material utilizado para la realización de los soportes regulables Special Light es el polipropileno de primera calidad con aditivos adecuados para garantizar una larga duración y aumentar la resistencia de carga.



Il sistema di bloccaggio antisvitamento totale permette di raggiungere la massima altezza senza oltrepassarla.

The self-locking blocking system allows you to reach the maximum height without the risk of exceeding it.

El sistema de bloqueo antideslizamiento total permite alcanzar la altura máxima sin superarla.

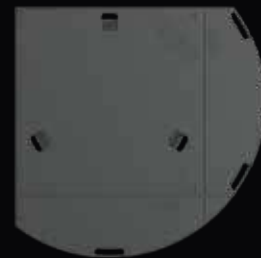
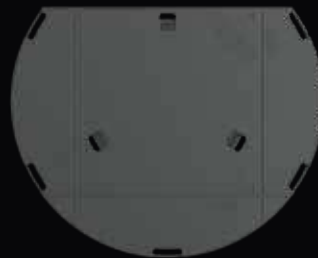
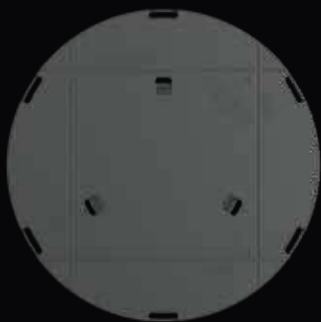

La base presenta dei fori appositamente studiati per l'ottimale scarico dell'acqua e nella parte sottostante degli incavi guida per il taglio della base permettendo la posa a filo parete o in un angolo.

The base has specially designed hole that allow for the optimum drainage of rain water. The underside is marked to allow for cutting in the case of installation along edges and corners.

La base tiene orificios específicamente estudiados para un desagüe correcto del agua y en la parte inferior de las ranuras de guía para el corte de la base, permitiendo la colocación al ras de la pared o en una esquina.

PAVIMENTAZIONI SOPRAELEVATE DA ESTERNO
 RAISED FLOORS FOR EXTERIORS
 SUELOS ELEVADOS PARA EXTERIORES

SPECIAL LIGHT CON TESTA FISSA

SPECIAL LIGHT WITH FIXED HEAD

SPECIAL LIGHT CON CABEZA FIJA

BASAMENTO REGOLABILE
ADJUSTABLE PAVING SUPPORT
SOPORTE REGULABLE

Art.	187	22 ÷ 35 mm.
Art.	187.1	35 ÷ 55 mm.
Art.	187.2	55 ÷ 95 mm.
Art.	187.3	95 ÷ 165 mm.
Art.	187.4	165 ÷ 235 mm.
Art.	187.5	200 ÷ 270 mm.
Art.	187.6	260 ÷ 340 mm.
Art.	187.7	305 ÷ 375 mm.
Art.	187.8	365 ÷ 445 mm.
Art.	187.9	410 ÷ 480 mm.
Art.	187.10	470 ÷ 550 mm.



TESTA PIANA - FLAT HEAD - CABEZA PLANA



2 mm - h 10 mm

ALETTE FUGA - THICK SPACERS - ALETAS JUNTA



4 mm - h 10 mm

ALETTE FUGA - THICK SPACERS - ALETAS JUNTA



6 mm - h 10 mm

ALETTE FUGA - THICK SPACERS - ALETAS JUNTA



8 mm - h 10 mm

ALETTE FUGA - THICK SPACERS - ALETAS JUNTA



10 mm - h 10 mm

ALETTE FUGA - THICK SPACERS - ALETAS JUNTA



TESTA FISSA / FIXED HEAD / CABEZA FIJA

La testa fissa è disponibile in versione piana, con alette fuga pre-intagliate con spessore 2, 4, 6, 8, 10 mm. e Ø 120 mm.

The fixed head is available in the flat version or with pre-cut 2, 4, 6, 8, 10 mm spacers Ø 120 mm.

La cabeza fija está disponible en versión plana, con aletas junta precortadas de 2, 4, 6, 8 y 10 mm de espesor y Ø 120 mm.

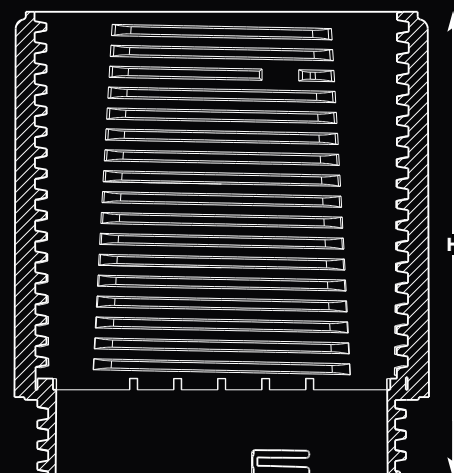
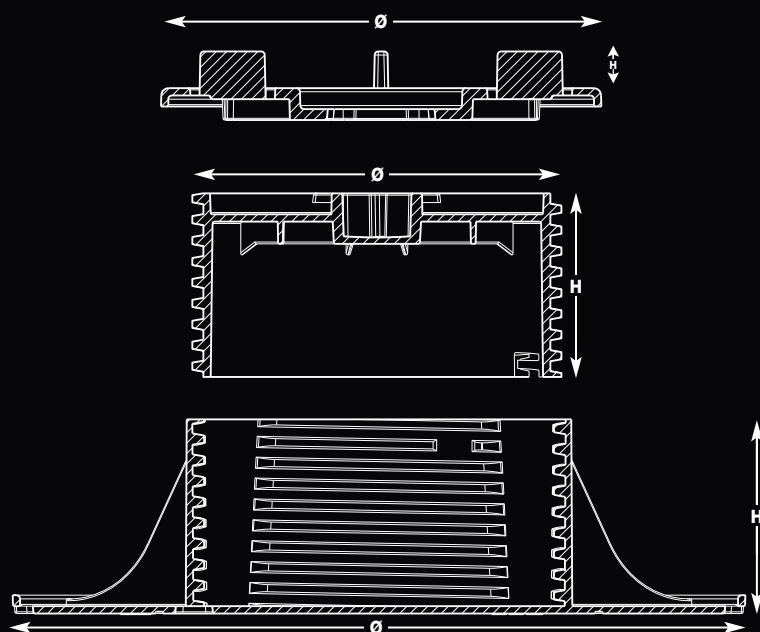

COMPOSIZIONE BASAMENTI REGOLABILI SPECIAL LIGHT / COMPOSITION OF ADJUSTABLE SUPPORTS SPECIAL LIGHT / COMPOSICIÓN SOPORTES REGULABLES SPECIAL LIGHT										
ARTICOLO CODE ART ARTÍCULO	MISURE SIZE MEDIDAS		BASE BASE BASE		VITE FILETTATA THREADED SCREW TORNILLO ROSCADO		PROLUNGA A MANICOTTO THREADED EXTENSION EXTENSIÓN CON MANGUITO		TESTA FISSA FIXED HEAD CABEZA FIJA	
codice code código	da mm. from mm. de mm.	a mm. to mm. a mm.	Ø mm.	h. mm.	Ø mm.	h. mm.	pezzi n. pieces n. cant. piezas	h. mm.	Ø mm.	h. mm.
187	22	35	200	20	100	17		126	120	10
187.1	35	55	200	33	100	30		126	120	10
187.2	55	95	200	53	100	50		126	120	10
187.3	95	165	200	93	100	90		126	120	10
187.4	165	235	200	93	100	160		126	120	10
187.5	200	270	200	93	100	90	1	126	120	10
187.6	260	340	200	93	100	160	1	126	120	10
187.7	305	375	200	93	100	90	2	126	120	10
187.8	365	445	200	93	100	160	2	126	120	10
187.9	410	480	200	93	100	90	3	126	120	10
187.10	470	550	200	93	100	160	3	126	120	10

Per garantire la portata e la perfetta efficienza del sistema di regolazione, si raccomanda di non oltrepassare la misura massima dichiarata nella descrizione del prodotto.

In order to guarantee the perfect efficiency of the regulation system, it is highly recommended not to exceed the maximum height indicated in the product description.

Para garantizar la capacidad de carga y la perfecta eficiencia del sistema de regulación, se recomienda no superar la medida máxima indicada en la descripción del producto.

ARTICOLI OPZIONALI SPECIAL LIGHT

OPTIONAL ITEMS SPECIAL LIGHT

ARTÍCULOS OPCIONALES SPECIAL LIGHT

Art. 188.4

PROLUNGA FILETTATA - SLEEVE EXTENSION - EXTENSIÓN ROSCADA

La prolunga filettata viene utilizzata per basamenti regolabili dai 235 mm ai 550 mm.

The sleeve extension is used for adjustable support systems from 235 mm to 550 mm.

La extensión roscada se utiliza para los soportes regulables de 235 mm a 550 mm.



Art. 187HS

SILENZIATORE TESTA ANTIDRUCCIOLO - NON-SLIP HEAD SILENCER ALMOHADILLA CABEZA ANTIDESLIZANTE

I silenziatori per teste prodotti in gomma fonoassorbente e antisdrucciolo sono studiati per abbattere il rumore derivante dal calpestio presente nelle pavimentazioni sopraelevate, inoltre fungono anche da antisdrucciolo per la pavimentazione installata. Vengono installati direttamente sulla parte superiore della testa e non necessitano di essere fissati.

The silencers for heads produced in sound-absorbing and non-slip rubber are designed to reduce the noise deriving from the trampling present in the raised floors, and also act as non-skid for the installed flooring. They are installed directly on the top of the head and they do not need to be fixed.

Las almohadillas para cabezas producidas en caucho insonorizante y antideslizante están diseñadas para reducir el ruido provocado por las pisadas en los suelos elevados y también actúan como antideslizante para el suelo instalado. Se instalan directamente en la parte superior de la cabeza y no necesitan ser fijadas.



Art. 187CL1 - 187CL1.67 - 187CL2

CUNEO LIVELLANTE - LEVELLER SHIMS - CUÑA NIVELADORA

Il cuneo livellante, disponibile nelle versioni 1%, 1,67% e 2%, viene impiegato nei sottofondi dove vi è la presenza di pendenza. Ideale per essere utilizzato con la linea Special Light, viene appoggiato direttamente sul piano di posa per poi poterci posare il basamento, creando così una superficie finita perfettamente piana.

The leveller shims, available in the 1%, 1,67% and 2% versions, are used in bases where there is a slope. Ideal to be used with our Special Light range, are placed directly on the laying surface to then be able to lay the support, thus creating a perfectly flat finished surface.

La cuña niveladora, disponible en las versiones de 1%, 1,67% y 2%, se utiliza en los sustratos donde está la pendiente. Ideal para ser utilizada con la línea Special Light, se apoya directamente sobre la superficie de colocación para luego montar el soporte, creando así una superficie terminada perfectamente en plano.



Art. 186.6

CHIAVE DI REGOLAZIONE ITALPROFILI 50 CM ITALPROFILI REGULATING KEY 50 CM LLAVE DE REGULACIÓN ITALPROFILI 50 CM

Chiave di regolazione l. 500 mm., utilizzabile a pavimentazione ultimata con fughe 4 - 6 - 8 - 10 mm.

Regulating key l. 500 mm., used for paving completed with 4 - 6 - 8 - 10 mm spacers.

Llave de regulación de 500 mm. de largo, que se utiliza con el suelo terminado con juntas de 4 - 6 - 8 - 10 mm.



Art. 186.6 C

CHIAVE DI REGOLAZIONE ITALPROFILI 25 CM ITALPROFILI REGULATING KEY 25 CM LLAVE DE REGULACIÓN ITALPROFILI 25 CM

Chiave di regolazione l. 250 mm., utilizzabile a pavimentazione ultimata con fughe 4 - 6 - 8 - 10 mm.

Regulating key l. 250 mm., used for paving completed with 4 - 6 - 8 - 10 mm spacers.

Llave de regulación de 250 mm. de largo, que se utiliza con el suelo terminado con juntas de 4 - 6 - 8 - 10 mm.



Art. 186.5

SPESSORE LIVELLANTE - LEVELING SPACER - ESPESOR NIVELANTE

Lo spessore livellante da 1,5 a 5 mm. può essere usato interamente, è impilabile o sezionabile per 1/2 o 1/4. Viene impiegato nei casi in cui la superficie di appoggio sia molto irregolare o per colmare i dislivelli creati dai sormonti del manto impermeabile. Può essere utilizzato anche per aumentare l'altezza finale del basamento di 5 mm.

The leveling spacer, from 1,5 to 5 mm. , can be used as a whole, and can also be stacked or sectioned by 1/2 or 1/4. These components are used when the support surface is extremely irregular or to compensate for the differences in level created by overlaps in the waterproofing layer. It can also be used to increase the final height with 5 mm.

El espesor nivelante de 1,5 a 5 mm se puede utilizar por completo, apilar o cortar por 1/2 o 1/4. Se utiliza cuando la superficie de apoyo es muy irregular o para colmar los desniveles creados por el solapado de la membrana impermeable. También se puede utilizar para aumentar 5 mm la altura final del soporte.



Art. 185CV2 - 185CV4

SET CLIP CHIUSURA VERTICALI FUGA 2/4 mm - SET CLIP FOR VERTICAL CLOSURE SPACER 2/4 mm - JUEGO DE CERRAMIENTOS VERTICALES JUNTA 2/4 mm

Il set clip chiusura verticali Italprofili sono studiati per dare un aggancio robusto ed esteticamente gradevole alle chiusure dei bordi perimetrali verticali nelle pavimentazioni sopraelevate, creando così un contenimento perimetrale per la pavimentazione. Realizzate in acciaio inox spessore 0,8 mm. sono disponibili con fuga 2 o 4 mm.

The Italprofili set clip for vertical closure is designed to give a strong and aesthetically pleasing attachment to the closing of the vertical perimeter edges in raised floors, thus creating a perimeter containment for the flooring. Made of 0,8 mm thick stainless steel, they are available with 2 or 4 mm spacers.

Los juegos de cerramientos verticales Italprofili están diseñados para un enganche fuerte y estéticamente agradable en los remates de los bordes perimetrales verticales en los suelos elevados, creando así una contención perimetral para el pavimento. Hechos de acero inoxidable de 0,8 mm de espesor, están disponibles con juntas de 2 o 4 mm.

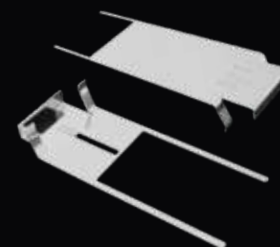

Art. 185DP2 - 185DP4

DISTANZIALE PERIMETRALE INOX FUGA 2/4 mm - PERIMETRAL SPACER STAINLESS STEEL FOR HEAD SPACER 2/4 mm - DILATADOR PERIMETRAL ACERO INOX JUNTA 2/4 mm

Il distanziale perimetrale viene posato direttamente sopra la testa permettendo di tenere distanziata di 5 mm. la pavimentazione dal perimetro verticale di contenimento. Opportunamente sagomato per evitare lo sfregamento della pavimentazione sul perimetro verticale di contenimento ed assorbire eventuali movimenti e dilatazioni della pavimentazione. Realizzato in acciaio inox, spessore di 0,8 mm.

The perimetral spacer is laid directly on the head allowing to keep the flooring of a distance of 5 mm from the vertical containment perimeter. Suitably shaped to avoid the rubbing of the pavement on the vertical containment perimeter and to absorb any movement and expansion of the pavement. Made of stainless steel, 0,8 mm thick.

El dilatador perimetral se coloca directamente sobre la cabeza, permitiendo mantener el pavimento a 5 mm de distancia del perímetro vertical de contención. Tiene una forma adecuada para evitar que el pavimento frote sobre el perímetro vertical de contención y para absorber posibles movimientos y dilataciones del pavimento. Está hecho de acero inoxidable de 0,8 mm de espesor.



Art. 190

PINZA POSAPIASTRE PER PIASTRE DI LATO 30 - 35 - 40 - 45 - 50 CM PAVING SLAB HANDLER 30 - 35 - 40 - 45 - 50 CM PINZA ESPESORADA PARA LOSAS DE 30 - 35 - 40 - 45 - 50 CM DE LADO



Art. 195

VENTOSA ALZAPIASTRELLE 110KG SUCTION CUP TILE LIFTER 110KG VENTOSA SUBIDA BALDOSAS 110 KG



VOCE DI CAPITOLATO DEI BASAMENTI REGOLABILI SPECIAL LIGHT DESCRIPTION FOR SPECIFICATION OF THE ADJUSTABLE SPECIAL LIGHT PAVING SUPPORTS ESPECIFICACIONES TÉCNICAS DE LOS SOPORTES REGULABLES SPECIAL LIGHT

BASAMENTI REGOLABILI SPECIAL LIGHT

Fornitura e posa in opera di basamenti regolabili del tipo Italprofili linea Special Light in polipropilene, per la realizzazione di pavimentazioni sopraelevate da esterno con finitura ceramica.

Il basamento è composto da:

- Base filettata
- Vite filettata
- Testa Special Light fissa con fuga disponibile da 2,4,6,8, e 10 mm.

ADJUSTABLE SPECIAL LIGHT PAVING SUPPORTS

Supply and installation of adjustable Special Light paving supports made of polypropylene, for the realisation of raised floors for exteriors with ceramic.

The support consists of:

- Threaded base
- Threaded screw
- Fixed head Special Light with spacer-tabs available in 2,4,6,8, and 10 mm.

SOPORTES REGULABLES SPECIAL LIGHT

Suministro y puesta en obra de soportes regulables de tipo Italprofili línea Special Light de polipropileno, para la realización de suelos elevados de exterior con acabado cerámico.

La base se compone de:

- Base roscada
- Tornillo roscado
- Cabeza Special Light fija con junta disponible de 2, 4, 6, 8 y 10 mm.

SPECIAL LIGHT JOIST

CON TESTA FISSA

SPECIAL LIGHT JOIST WITH FIXED HEAD

SPECIAL LIGHT JOIST CON CABEZA FIJA

BASAMENTO REGOLABILE ADJUSTABLE PAVING SUPPORT SOPORTE REGULABLE

Art. 187J	22 ÷ 35 mm.
Art. 187.1J	35 ÷ 55 mm.
Art. 187.2J	55 ÷ 95 mm.
Art. 187.3J	95 ÷ 165 mm.
Art. 187.4J	165 ÷ 235 mm.
Art. 187.5J	200 ÷ 270 mm.
Art. 187.6J	260 ÷ 340 mm.
Art. 187.7J	305 ÷ 375 mm.
Art. 187.8J	365 ÷ 445 mm.
Art. 187.9J	410 ÷ 480 mm.
Art. 187.10J	470 ÷ 550 mm.

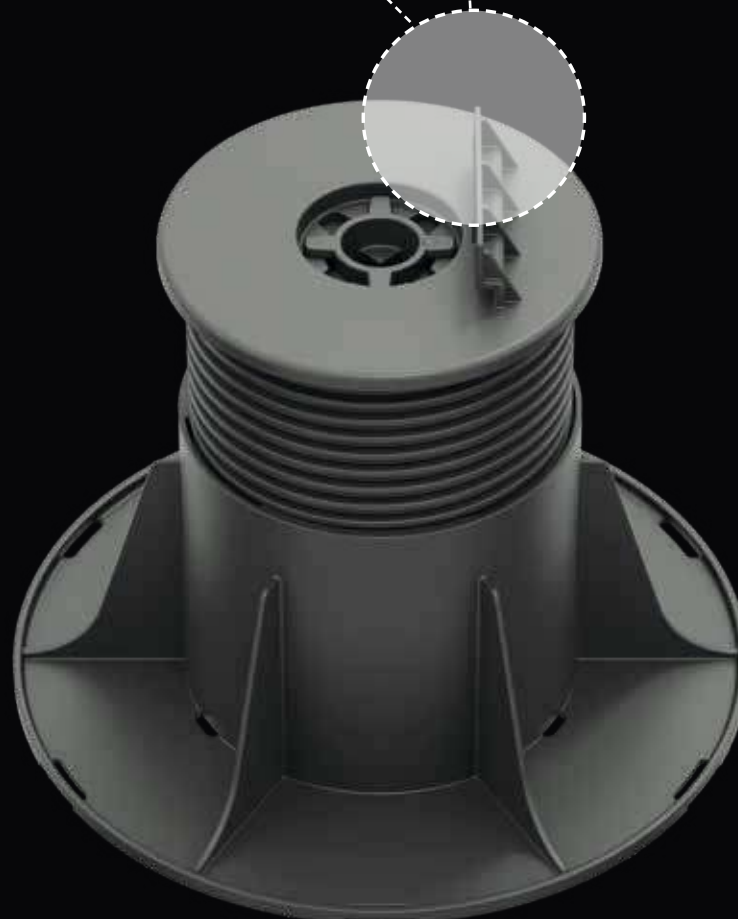
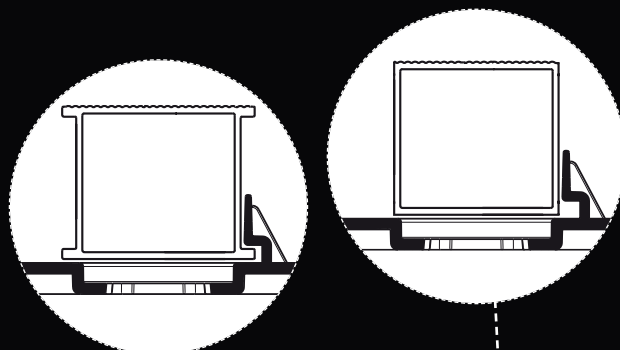

TESTA ADATTA PER QUALSIASI TIPO DI TRAVETTO HEAD SUITABLE TO ANY TYPE OF JOIST CABEZA APTA PARA CUALQUIER TIPO DE TRAVESAÑO

La sua speciale testa lo rende adatto a qualsiasi tipo di travetto. Viene utilizzato come supporto al di sotto di una pavimentazione sopraelevata, per rendere praticabili zone impermeabilizzate e non, permettere il passaggio di cavi e tubazioni che sono di norma posizionati all'interno del getto o interrati, permettendo così facile accesso in caso di manutenzioni. Nuova testa adatta per accogliere qualsiasi tipo di travetto per pavimentazioni decking.

Its special head make it suitable to any type of joist. It is the perfect solution for turning non practicable areas into practicable ones, whether they are waterproofed and not, it also allows for the passage of cables, pipes etc that are normally present in castings or basements, thus allowing easy access in case of maintenance. New head suitable to accommodate any type of joist for decking systems.

Gracias a su cabeza especial es apto para cualquier tipo de travesaño. Se utiliza como soporte debajo de un suelo elevado para volver practicables las zonas impermeabilizadas y otros tipos de zonas, permitir el paso de cables y tuberías que por lo general están colocadas dentro de la colada de hormigón o enterradas, permitiendo así un fácil acceso en caso de mantenimiento. Nueva cabeza adecuada para montar cualquier tipo de travesaño para suelos de tarima.

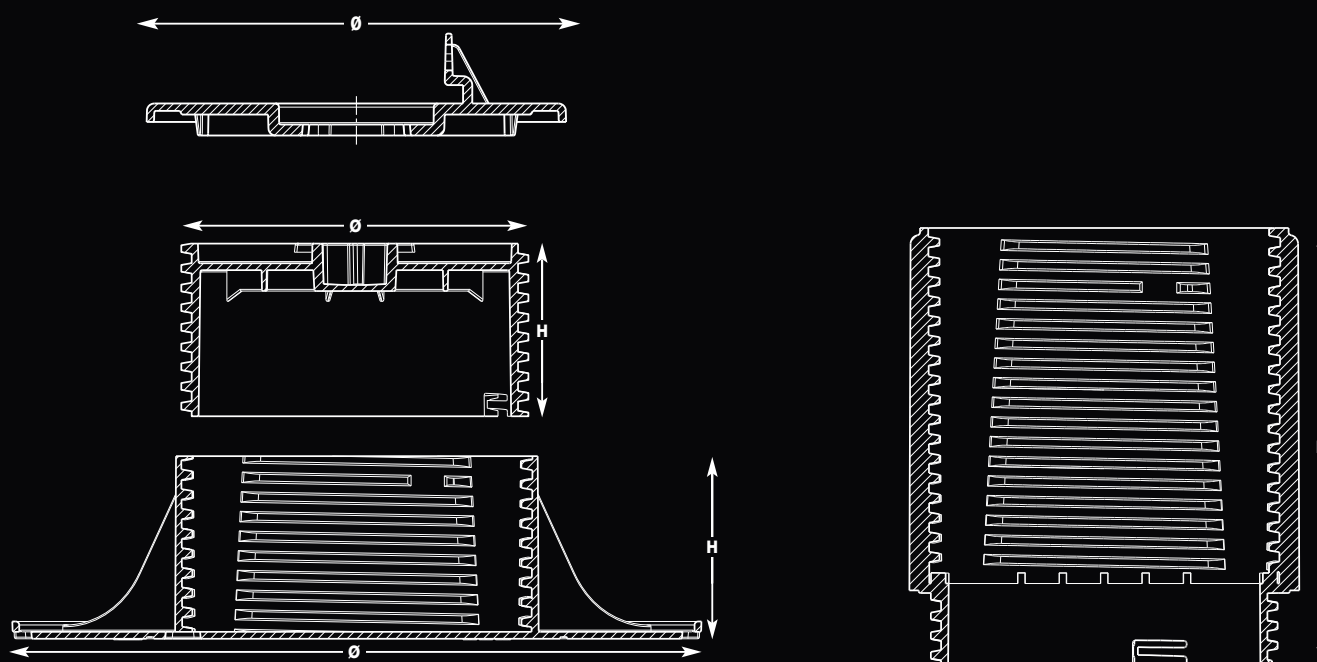

COMPOSIZIONE BASAMENTI REGOLABILI SPECIAL LIGHT JOIST / COMPOSITION OF ADJUSTABLE SUPPORTS SPECIAL LIGHT JOIST / COMPOSICIÓN SOPORTES REGULABLES SPECIAL LIGHT JOIST										
ARTICOLO CODE ART ARTÍCULO	MISURE SIZE MEDIDAS		BASE BASE BASE		VITE FILETTATA THREADED SCREW TORNILLO ROSCADO		PROLUNGA A MANICOTTO THREADED EXTENSION EXTENSIÓN CON MANGUITO		TESTA HEAD CABEZA	
codice code código	da mm. from mm. de mm.	a mm. to mm. a mm.	Ø mm.	h. mm.	Ø mm.	h. mm.	pezzi n. pieces n. cant. piezas	h. mm.	Ø mm.	h. mm.
187J	22	35	200	20	100	17		126	113	19
187.1J	35	55	200	33	100	30		126	113	19
187.2J	55	95	200	53	100	50		126	113	19
187.3J	95	165	200	93	100	90		126	113	19
187.4J	165	235	200	93	100	160		126	113	19
187.5J	200	270	200	93	100	90	1	126	113	19
187.6J	260	340	200	93	100	160	1	126	113	19
187.7J	305	375	200	93	100	90	2	126	113	19
187.8J	365	445	200	93	100	160	2	126	113	19
187.9J	410	480	200	93	100	90	3	126	113	19
187.10J	470	550	200	93	100	160	3	126	113	19

Per garantire la portata e la perfetta efficienza del sistema di regolazione, si raccomanda di non oltrepassare la misura massima dichiarata nella descrizione del prodotto.

In order to guarantee the perfect efficiency of the regulation system, it is highly recommended not to exceed the maximum height indicated in the product description.

Para garantizar la capacidad de carga y la perfecta eficiencia del sistema de regulación, se recomienda no superar la medida máxima indicada en la descripción del producto.

ARTICOLI OPZIONALI

SPECIAL LIGHT JOIST

OPTIONAL ITEMS SPECIAL LIGHT JOIST

ARTÍCULOS OPCIONALES SPECIAL LIGHT JOIST

Art. 188.4

PROLUNGA FILETTATA SLEEVE EXTENSION EXTENSIÓN ROSCADA

La prolunga filettata viene utilizzata per basamenti regolabili dai 235 mm ai 550 mm.

The sleeve extension is used for adjustable support systems from 235 mm to 550 mm.

La extensión roscada se utiliza para los soportes regulables de 235 mm a 550 mm.



Art. 187CL1 - 187CL1.67 - 187CL2

CUNEO LIVELLANTE - LEVELLER SHIMS - CUÑA NIVELADORA

Il cuneo livellante, disponibile nelle versioni 1%, 1,67% e 2%, viene impiegato nei sottofondi dove vi è la presenza di pendenza. Ideale per essere utilizzato con la linea Special Light, viene appoggiato direttamente sul piano di posa per poi poterci posare il basamento, creando così una superficie finita perfettamente piana.

The leveller shims, available in the 1%, 1,67% and 2% versions, are used in bases where there is a slope. Ideal to be used with our Special Light range, are placed directly on the laying surface to then be able to lay the support, thus creating a perfectly flat finished surface.

La cuña niveladora, disponible en las versiones de 1%, 1,67% y 2%, se utiliza en los sustratos donde está la pendiente. Ideal para ser utilizada con la línea Special Light, se apoya directamente sobre la superficie de colocación para luego montar el soporte, creando así una superficie terminada perfectamente en plano.



Art. 186.5

SPESSORE LIVELLANTE - LEVELING SPACER - ESPESOR NIVELANTE

Lo spessore livellante da 1,5 a 5 mm. può essere usato interamente, è impilabile o sezionabile per $\frac{1}{2}$ o $\frac{1}{4}$. Viene impiegato nei casi in cui la superficie di appoggio sia molto irregolare o per colmare i dislivelli creati dai sormonti del manto impermeabile. Può essere utilizzato anche per aumentare l'altezza finale del basamento di 5 mm.

The leveling spacer, from 1,5 to 5 mm., can be used as a whole, and can also be stacked or sectioned by $\frac{1}{2}$ or $\frac{1}{4}$. These components are used when the support surface is extremely irregular or to compensate for the differences in level created by overlaps in the waterproofing layer. It can also be used to increase the final height with 5 mm.

El espesor nivelante de 1,5 a 5 mm se puede utilizar por completo, apilar o cortar por $\frac{1}{2}$ o $\frac{1}{4}$. Se utiliza cuando la superficie de apoyo es muy irregular o para colmar los desniveles creados por el solapado de la membrana impermeable. También se puede utilizar para aumentar 5 mm la altura final del soporte.



Art. 186.6

CHIAVE DI REGOLAZIONE ITALPROFILI 50 CM ITALPROFILI REGULATING KEY 50 CM LLAVE DE REGULACIÓN ITALPROFILI 50 CM

Chiave di regolazione l. 500 mm., utilizzabile a pavimentazione ultimata con fughe 4 - 6 - 8 - 10 mm.

Regulating key l. 500 mm., used for paving completed with 4 - 6 - 8 - 10 mm spacers.

Llave de regulación de 500 mm. de largo, que se utiliza con el suelo terminado con juntas de 4 - 6 - 8 - 10 mm.

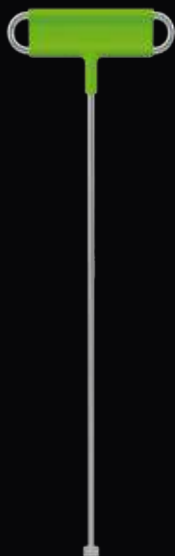

Art. 186.6 C

CHIAVE DI REGOLAZIONE ITALPROFILI 25 CM ITALPROFILI REGULATING KEY 25 CM LLAVE DE REGULACIÓN ITALPROFILI 25 CM

Chiave di regolazione l. 250 mm., utilizzabile a pavimentazione ultimata con fughe 4 - 6 - 8 - 10 mm.

Regulating key l. 250 mm., used for paving completed with 4 - 6 - 8 - 10 mm spacers.

Llave de regulación de 250 mm. de largo, que se utiliza con el suelo terminado con juntas de 4 - 6 - 8 - 10 mm.



VOCE DI CAPITOLATO DEI BASAMENTI REGOLABILI SPECIAL LIGHT JOIST DESCRIPTION FOR SPECIFICATION OF THE ADJUSTABLE SPECIAL LIGHT JOIST PAVING SUPPORTS ESPECIFICACIONES TÉCNICAS DE LOS SOPORTES REGULABLES SPECIAL LIGHT JOIST

BASAMENTI REGOLABILI SPECIAL LIGHT JOIST

Fornitura e posa in opera di basamenti regolabili del tipo Italprofili linea Special Light Joist in polipropilene, per la realizzazione di pavimentazioni sistema decking.

Il basamento è composto da:

- Base filettata
- Vite filettata
- Testa Special Light Joist fissa per qualsiasi tipo di travetto

ADJUSTABLE SPECIAL LIGHT JOIST PAVING SUPPORTS

Supply and installation of adjustable Special Light Joist paving supports made of polypropylene, for the realisation of raised floors with decking systems

The support consists of:

- Threaded base
- Threaded screw
- Fixed head Special Light Joist for any type of joists.

SOPORTES REGULABLES SPECIAL LIGHT JOIST

Suministro y puesta en obra de soportes regulables de tipo Italprofili línea Special Light Joist de polipropileno, para la realización de pavimentos sistema de tarima.

La base se compone de:

- Base roscada
- Tornillo roscado
- Cabeza Special Light Joist fija para cualquier tipo de viga



BASAMENTI REGOLABILI LINEA RAISE-UP



ADJUSTABLE SUPPORT SYSTEMS RAISE-UP

SOPORTES REGULABLES LÍNEA RAISE-UP

Basamento Raise-up: il più basso delle nostre linee di basamenti regolabili. È stato ideato per essere impiegato esternamente con pavimentazioni sopraelevate dove è richiesto uno spessore ridotto. Realizzato in polipropilene di prima scelta opportunamente additivato per garantire lunga durata nel tempo ed aumentare la resistenza di portata.

Adjustable support Raise-up: the lowest paving support among our ranges of adjustable paving support systems. It has been studied to be used externally with raised floors where a low thickness is required. It is produced using only the finest top grade polypropylene and additives, these top quality raw materials ensure its long durability and also increase the load capacity.

Soporte Raise-up: la más baja de nuestra líneas de soportes regulables. Se ha ideado para la utilización en el exterior con suelos elevados donde es necesario un espesor reducido. Realizado en polipropileno de primera calidad con unos aditivos adecuados para garantizar una larga duración en el tiempo y aumentar la resistencia de carga.

10 - 16 mm.

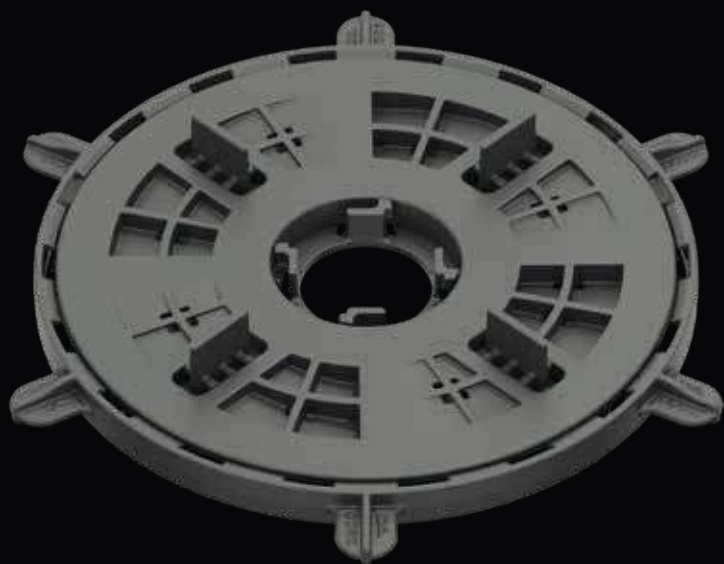

16 - 22 mm.

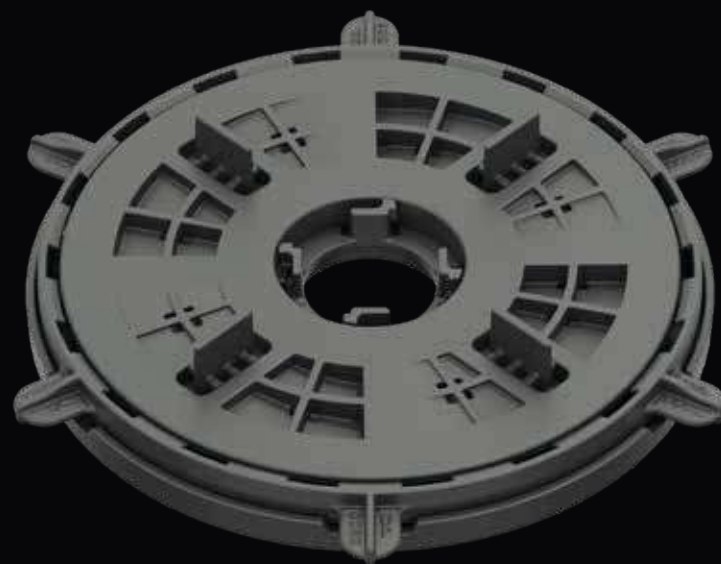



PAVIMENTAZIONI SOPRAELEVATE DA ESTERNO
RAISED FLOORS FOR EXTERIORS
SUELOS ELEVADOS PARA EXTERIORES

RAISE-UP CON TESTA FISSA

RAISE-UP WITH FIXED HEAD

RAISE-UP CON CABEZA FIJA

BASAMENTO REGOLABILE
ADJUSTABLE PAVING SUPPORT
SOPORTE REGULABLE

Art. 183 10 ÷ 16 mm - fuga 2mm/spacer tabs 2mm/ junta 2mm

Art. 184 10 ÷ 16 mm - fuga 4mm/spacer tabs 4mm/ junta 4mm

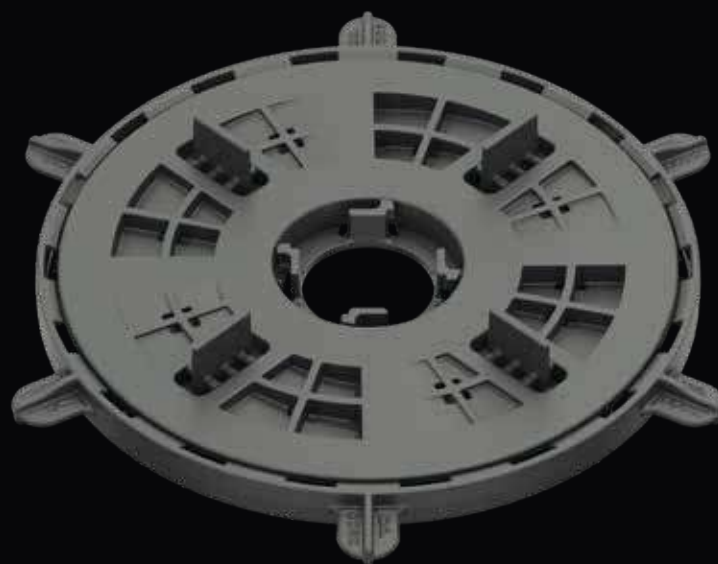

Art. 183.1 16 ÷ 22 mm - fuga 2mm/spacer tabs 2mm/ junta 2mm

Art. 184.1 16 ÷ 22 mm - fuga 4mm/spacer tabs 4mm/ junta 4mm

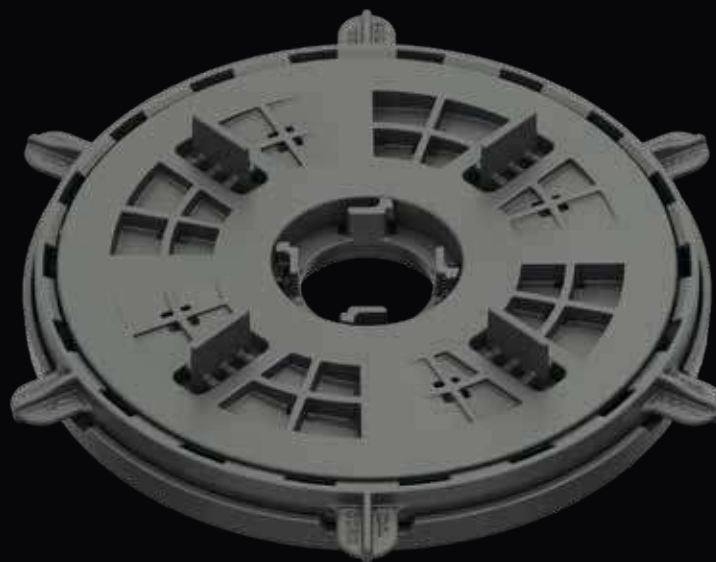

RAISE-UP CON TESTA FISSA - RAISE-UP WITH FIXED HEAD - RAISE-UP CON CABEZA FIJA

Art. 183 - Art. 184

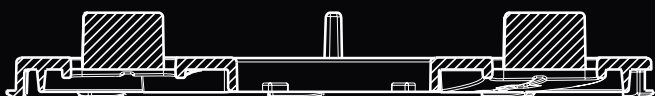

Art. 183.1 - Art. 184.1



COMPOSIZIONE BASAMENTI REGOLABILI RAISE-UP / COMPOSITION OF ADJUSTABLE SUPPORTS RAISE-UP/ COMPOSICIÓN SOPORTES REGULABLES RAISE-UP

ARTICOLO CODE ART ARTÍCULO	MISURE SIZE MEDIDAS		BASE BASE BASE		TESTA FISSA FIXED HEAD CABEZA FIJA		FUGA SPACER JUNTA		RIALZO RAISE-UP RAISE-UP LIFT ELEVACIÓN RAISE-UP	
	da mm. from mm. de mm.	a mm. to mm. a mm.	Ø mm.	h. mm.	Ø mm.	h. mm.	spessore mm. thickness mm. espesor mm.	h. mm.	Ø mm.	h. mm.
183	10	16	150	10	140	9	2	10		
183.1	16	22	150	16	140	9	2	10	156	6
184	10	16	150	10	140	9	4	10		
184.1	16	22	150	16	140	9	4	10	156	6

Per garantire la portata e la perfetta efficienza del sistema di regolazione, si raccomanda di non oltrepassare la misura massima dichiarata nella descrizione del prodotto.

In order to guarantee the perfect efficiency of the regulation system, it is highly recommended not to exceed the maximum height indicated in the product description.

Para garantizar la capacidad de carga y la perfecta eficiencia del sistema de regulación, se recomienda no superar la medida máxima indicada en la descripción del producto.

PAVIMENTAZIONI SOPRAELEVATE DA ESTERNO
RAISED FLOORS FOR EXTERIORS
SUELOS ELEVADOS PARA EXTERIORES

ARTICOLI OPZIONALI PER
RAISE-UP

OPTIONAL ITEMS FOR RAISE-UP

ARTÍCULOS OPCIONALES RAISE-UP

Art. 185HS

SILENZIATORE TESTA ANTIDRUCCIOLLO - NON-SLIP HEAD SILENCER - ALMOHADILLA CABEZA ANTIDESLIZANTE

I silenziatori per teste prodotti in gomma fonoassorbente e antiscivolo sono studiati per abbattere il rumore derivante dal calpestio presente nelle pavimentazioni sopraelevate, inoltre fungono anche da antiscivolo per la pavimentazione installata. Vengono installati direttamente sulla parte superiore della testa e non necessitano di essere fissati.

The silencers for heads produced in sound-absorbing and non-slip rubber are designed to reduce the noise deriving from the trampling present in the raised floors, and also act as non-skid for the installed flooring. They are installed directly on the top of the head and they do not need to be fixed.

Las almohadillas para cabezas producidas en caucho insonorizante y antideslizante están diseñadas para reducir el ruido provocado por las pisadas en los suelos elevados y también actúan como antideslizante para el suelo instalado. Se instalan directamente en la parte superior de la cabeza y no necesitan ser fijadas.

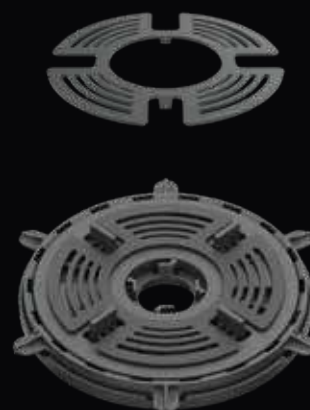

ART. 185DP2 - 185DP4

DISTANZIALE PERIMETRALE INOX FUGA 2/4 mm

PERIMETRAL SPACER STAINLESS STEEL FOR HEAD SPACER 2/4 mm

DILATADOR PERIMETRAL ACERO INOX JUNTA 2/4 mm

Il distanziale perimetrale viene posato direttamente sopra la testa permettendo di tenere distanziata di 5 mm la pavimentazione dal perimetro verticale di contenimento. Opportunamente sagomato per evitare lo sfregamento della pavimentazione sul perimetro verticale di contenimento ed assorbire eventuali movimenti e dilatazioni della pavimentazione. Realizzato in acciaio inox, spessore di 0,8 mm.

The perimetral spacer is laid directly on the head allowing to keep the flooring of a distance of 5 mm from the vertical containment perimeter. Suitably shaped to avoid the rubbing of the pavement on the vertical containment perimeter and to absorb any movement and expansion of the pavement. Made of stainless steel, 0,8 mm thick.

El dilatador perimetral se coloca directamente sobre la cabeza, permitiendo mantener el pavimento a 5 mm de distancia del perímetro vertical de contención. Tiene una forma adecuada para evitar que el pavimento frote sobre el perímetro vertical de contención y para absorber posibles movimientos y dilataciones del pavimento. Está hecho de acero inoxidable de 0,8 mm de espesor.



Art. 190

PINZA POSAPIASTRE PER PIASTRE DI LATO 30 - 35 - 40 - 45 - 50 CM

PAVING SLAB HANDLER 30 - 35 - 40 - 45 - 50 CM

PINZA ESPESORADA PARA LOSAS DE 30 - 35 - 40 - 45 - 50 CM DE LADO



Art. 195

VENTOSA ALZAPIASTRELLE 110KG

SUCTION CUP TILE LIFTER 110KG

VENTOSA SUBIDA BALDOSAS 110 KG



Art. 186.5

SPESSORE LIVELLANTE - LEVELING SPACER - ESPESOR NIVELANTE

Lo spessore livellante da 1,5 a 5 mm. può essere usato interamente, è impilabile o sezionabile per 1/2 o 1/4. Viene impiegato nei casi in cui la superficie di appoggio sia molto irregolare o per colmare i dislivelli creati dai sormonti del manto impermeabile. Può essere utilizzato anche per aumentare l'altezza finale del basamento di 5 mm.

The leveling spacer, from 1,5 to 5 mm. , can be used as a whole, and can also be stacked or sectioned by 1/2 or 1/4. These components are used when the support surface is extremely irregular or to compensate for the differences in level created by overlaps in the waterproofing layer. It can also be used to increase the final height with 5 mm.

El espesor nivelante de 1,5 a 5 mm se puede utilizar por completo, apilar o cortar por 1/2 o 1/4. Se utiliza cuando la superficie de apoyo es muy irregular o para colmar los desniveles creados por el solapado de la membrana impermeable. También se puede utilizar para aumentar 5 mm la altura final del soporte.



ART. 183.4

RIALZO RAISE-UP 6 MM. - RAISE-UP LIFT 6 MM. - ELEVACIÓN RAISE-UP 6 MM.

Il rialzo Raise-up è applicabile solo sull'Art. 183 e 184 e consente di modificare l'altezza del basamento di 6 mm. ottenendo la nuova misura 16-22 mm.

The Raise-up lift is applicable only on Art. 183 and 184 and allows to change the height of the base of 6 mm. obtaining the new measure 16-22 mm.

La elevación Raise-up se puede aplicar solo al Art. 183 y 184 y permite modificar 6 mm la altura de la base obteniendo una nueva medida 16-22 mm.



VOCE DI CAPITOLATO DEI BASAMENTI REGOLABILI RAISE-UP DESCRIPTION FOR SPECIFICATION OF THE ADJUSTABLE RAISE-UP PAVING SUPPORTS ESPECIFICACIONES TÉCNICAS DE LOS SOPORTES REGULABLES RAISE-UP

BASAMENTI REGOLABILI RAISE-UP

Fornitura e posa in opera di basamenti regolabili del tipo Italprofili linea Raise-up in polipropilene, per la realizzazione di pavimentazioni sopraelevate da esterno con finitura ceramica.

Il basamento è composto da:

- Base a rampe inclinate
- Testa a rampe inclinate con alette integrate, fuga disponibile da 2 e 4 mm.
- Rialzo 6 mm. (su versione 16-22 mm.)

ADJUSTABLE SPECIAL LIGHT RAISE-UP

Supply and installation of adjustable Raise-up paving supports made of polypropylene, for the realisation of raised floors for exteriors with ceramic.

The support consists of:

- Base with inclined ramps
- Head with inclined ramps and integrated spacers available in 2 and 4 mm.
- Lift 6 mm. (on the support 16-22 mm.)

SOPORTES REGULABLES RAISE-UP

Suministro y puesta en obra de soportes regulables de tipo Italprofili línea Raise-up de polipropileno, para la realización de suelos elevados de exterior con acabado cerámico.

La base se compone de:

- Base de rampas inclinadas
- Cabeza de rampas inclinadas con aletas integradas, junta disponible de 2 y 4 mm.
- Elevación 6 mm. (en versión 16-22 mm.)



ITALPROFILI[®]
RESISTANT TO TIME



CONSUMI A MQ. BASAMENTI REGOLABILI CON FINITURA PAVIMENTAZIONE CERAMICA

Le seguenti tabelle indicano il fabbisogno a mq dei basamenti regolabili per pavimentazioni sopraelevate con finitura ceramica.

I conteggi sono stati sviluppati in base ai formati di piastrelle quadrati o rettangolari per porzioni di aree da pavimentare:

- Centrali
- Perimetrali
- Angolari

Esempi di posa appaiata o sfalsata con basamenti posati sugli angoli o sugli angoli e centrale.

CONSUMPTIONS OF ADJUSTABLE PAVING SUPPORTS PER SQM. WITH CERAMIC FLOORING

The following tables indicate the requirements per square meter of the adjustable paving supports for raised floors with ceramic.

The calculations have been developed according to square or rectangular tile formats, for portions of areas to be paved:

- Central
- Perimetral
- Angular

Examples of paired or not aligned laying with supports placed on the corners or on the corners and central.

CONSUMOS POR M2 SOPORTES REGULABLES CON ACABADO PAVIMENTO CERÁMICA

Las siguientes tablas indican las necesidades por m2 de los soportes regulables para suelos elevados con acabados de tarima.

Los recuentos se han realizado según los formatos de baldosas cuadradas o rectangulares para las partes de suelo que solar.

- Centrales
- Perimetrales
- Angulares

Ejemplos de puesta a junta corrida o a rompejuntas con soportes puestos en las esquinas o en las esquinas y central.

FORMATO QUADRATO CON BASAMENTO POSATO SUGLI ANGOLI SQUARE SHAPED PAVER WITH SUPPORT PLACED ON THE CORNERS FORMATO CUADRADO CON SOPORTE COLOCADO EN LAS ESQUINAS

30 x 30 cm

CENTRALI - CENTRAL - CENTRALES	PERIMETRALI - PERIMETRAL - PERIMETRALES	ANGOLARI - ANGULAR - ANGULARES
PZ/MQ 11,11	PZ/MQ 12,5	PZ/MQ 14,06

40 x 40 cm

CENTRALI - CENTRAL - CENTRALES	PERIMETRALI - PERIMETRAL - PERIMETRALES	ANGOLARI - ANGULAR - ANGULARES
PZ/MQ 6,25	PZ/MQ 7,29	PZ/MQ 8,51

LEGENDA - LEGEND - LEGENDA

1 mq 1 sq. m 1 mc	Linea perimetrale Perimetral line Linea perimetral	Linea d'angolo Corner line Línea de ángulo	Basamento Support Soporte	Piastra dimensioni variabili Slab with variable dimensions Losa de medidas variables
-------------------------	--	--	---------------------------------	--

I quantitativi possono variare in funzione dell'area da pavimentare.
 Quantities can varied based on the geometry of the area to be paved.
 Las cantidades pueden variar de acuerdo con la zona que se deba solar.

FORMATO QUADRATO CON BASAMENTO POSATO SUGLI ANGOLI SQUARE SHAPED PAVER WITH SUPPORT PLACED ON THE CORNERS FORMATO CUADRADO CON SOPORTE COLOCADO EN LAS ESQUINAS

45 x 45 cm

CENTRALI - CENTRAL - CENTRALES	PERIMETRALI - PERIMETRAL - PERIMETRALES	ANGOLARI - ANGULAR - ANGULARES
PZ/MQ 4,94	PZ/MQ 5,76	PZ/MQ 6,72

50 x 50 cm

CENTRALI - CENTRAL - CENTRALES	PERIMETRALI - PERIMETRAL - PERIMETRALES	ANGOLARI - ANGULAR - ANGULARES
PZ/MQ 4	PZ/MQ 5	PZ/MQ 6,25

LEGENDA - LEGEND - LEGENDA

1 mq 1 sq. m 1 mc	Linea perimetrale Perimetral line Linea perimetral	Linea d'angolo Corner line Linea de ángulo	Basamento Support Soporte	Piastra dimensioni variabili Slab with variable dimensions Losas de medidas variables
-------------------------	--	--	---------------------------------	---

I quantitativi possono variare in funzione dell'area da pavimentare.
 Quantities can varied based on the geometry of the area to be paved.
 Las cantidades pueden variar de acuerdo con la zona que se deba solar.

FORMATO QUADRATO CON BASAMENTO POSATO SUGLI ANGOLI
SQUARE SHAPED PAVER WITH SUPPORT PLACED ON THE CORNERS
FORMATO CUADRADO CON SOPORTE COLOCADO EN LAS ESQUINAS

60 x 60 cm

CENTRALI - CENTRAL - CENTRALES	PERIMETRALI - PERIMETRAL - PERIMETRALES	ANGOLARI - ANGULAR - ANGULARES
PZ/MQ 2,78	PZ/MQ 3,47	PZ/MQ 4,34

75 x 75 cm

CENTRALI - CENTRAL - CENTRALES	PERIMETRALI - PERIMETRAL - PERIMETRALES	ANGOLARI - ANGULAR - ANGULARES
PZ/MQ 1,78	PZ/MQ 2,22	PZ/MQ 2,78

LEGENDA - LEGEND - LEGENDA									
	1 mq 1 sq. m 1 mc		Linea perimetrale Perimetral line Linea perimetral		Linea d'angolo Corner line Linea de ángulo		Basamento Support Soporte		Piastra dimensioni variabili Slab with variable dimensions Losas de medidas variables

I quantitativi possono variare in funzione dell'area da pavimentare.
 Quantities can varied based on the geometry of the area to be paved.
 Las cantidades pueden variar de acuerdo con la zona que se deba solar.





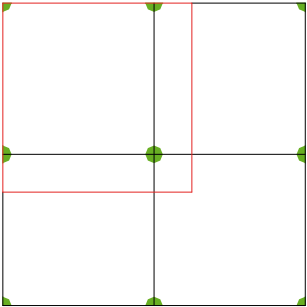
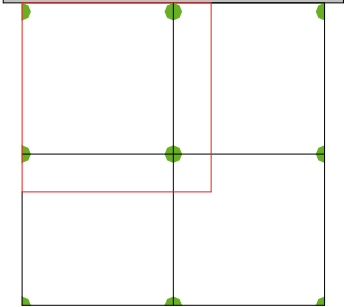
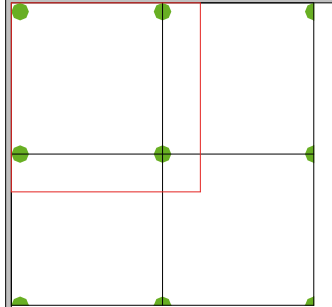

FORMATO QUADRATO CON BASAMENTO POSATO SUGLI ANGOLI
SQUARE SHAPED PAVER WITH SUPPORT PLACED ON THE CORNERS
FORMATO CUADRADO CON SOPORTE COLOCADO EN LAS ESQUINAS

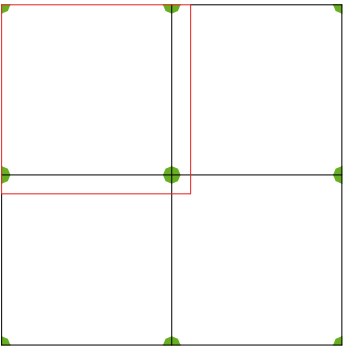
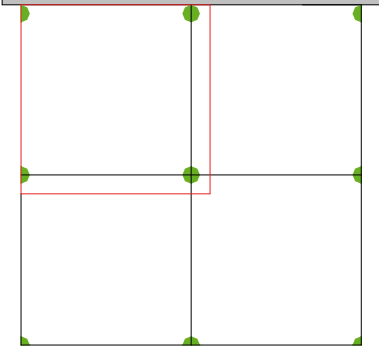
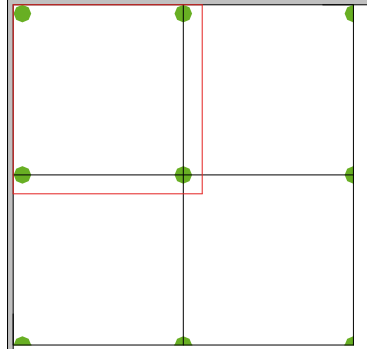
80 x 80 cm

CENTRALI - CENTRAL - CENTRALES	PERIMETRALI - PERIMETRAL - PERIMETRALES	ANGOLARI - ANGULAR - ANGULARES
		
PZ/MQ 1,56	PZ/MQ 1,95	PZ/MQ 2,44

90 x 90 cm

CENTRALI - CENTRAL - CENTRALES	PERIMETRALI - PERIMETRAL - PERIMETRALES	ANGOLARI - ANGULAR - ANGULARES
		
PZ/MQ 1,24	PZ/MQ 1,54	PZ/MQ 1,93





LEGENDA - LEGEND - LEGENDA				
 1 mq  1 sq. m  1 mc	Linea perimetrale Perimetral line Línea perimetral	 Linea d'angolo Corner line Línea de ángulo	 Basamento Support Soporte	 Piastra dimensioni variabili Slab with variable dimensions Losa de medidas variables

I quantitativi possono variare in funzione dell'area da pavimentare.
 Quantities can varied based on the geometry of the area to be paved.
 Las cantidades pueden variar de acuerdo con la zona que se deba solar.

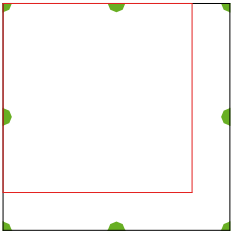
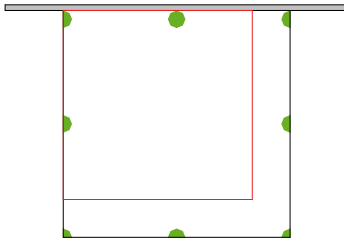
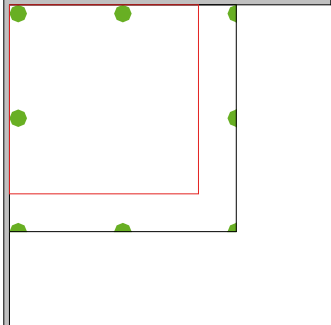
FORMATO QUADRATO CON BASAMENTO POSATO SUGLI ANGOLI
SQUARE SHAPED PAVER WITH SUPPORT PLACED ON THE CORNERS
FORMATO CUADRADO CON SOPORTE COLOCADO EN LAS ESQUINAS

120 x 120 cm

CENTRALI - CENTRAL - CENTRALES	PERIMETRALI - PERIMETRAL - PERIMETRALES	ANGOLARI - ANGULAR - ANGULARES
		
PZ/MQ 2,08	PZ/MQ 2,78	PZ/MQ 3,65

LEGENDA - LEGEND - LEGENDA									
	1 mq 1 sq. m 1 mc		Linea perimetrale Perimetral line Linea perimetral		Linea d'angolo Corner line Linea de ángulo		Basamento Support Soporte		Piastra dimensioni variabili Slab with variable dimensions Losa de medidas variables

I quantitativi possono variare in funzione dell'area da pavimentare.
 Quantities can varied based on the geometry of the area to be paved.
 Las cantidades pueden variar de acuerdo con la zona que se deba solar.

FORMATO QUADRATO CON BASAMENTO POSATO SUGLI ANGOLI E CENTRALE
SQUARE SHAPED PAVER WITH SUPPORT PLACED CENTRAL AND ON THE CORNERS
FORMATO CUADRADO CON SOPORTE COLOCADO EN LAS ESQUINAS Y CENTRAL

30 x 30 cm

CENTRALI - CENTRAL - CENTRALES	PERIMETRALI - PERIMETRAL - PERIMETRALES	ANGOLARI - ANGULAR - ANGULARES
PZ/MQ 22,22	PZ/MQ 23,61	PZ/MQ 25,17

40 x 40 cm

CENTRALI - CENTRAL - CENTRALES	PERIMETRALI - PERIMETRAL - PERIMETRALES	ANGOLARI - ANGULAR - ANGULARES
PZ/MQ 12,5	PZ/MQ 13,54	PZ/MQ 14,76

LEGENDA - LEGEND - LEGENDA

1 mq 1 sq. m 1 mc	Linea perimetrale Perimetral line Linea perimetral	Linea d'angolo Corner line Línea de ángulo	Basamento Support Soporte	Piastra dimensioni variabili Slab with variable dimensions Losa de medidas variables
-------------------------	--	--	---------------------------------	--

I quantitativi possono variare in funzione dell'area da pavimentare.
 Quantities can varied based on the geometry of the area to be paved.
 Las cantidades pueden variar de acuerdo con la zona que se deba solar.

FORMATO QUADRATO CON BASAMENTO POSATO SUGLI ANGOLI E CENTRALE
SQUARE SHAPED PAVER WITH SUPPORT PLACED CENTRAL AND ON THE CORNERS
FORMATO CUADRADO CON SOPORTE COLOCADO EN LAS ESQUINAS Y CENTRAL

45 x 45 cm

CENTRALI - CENTRAL - CENTRALES	PERIMETRALI - PERIMETRAL - PERIMETRALES	ANGOLARI - ANGULAR - ANGULARES
PZ/MQ 9,88	PZ/MQ 10,7	PZ/MQ 11,66

50 x 50 cm

CENTRALI - CENTRAL - CENTRALES	PERIMETRALI - PERIMETRAL - PERIMETRALES	ANGOLARI - ANGULAR - ANGULARES
PZ/MQ 8	PZ/MQ 9	PZ/MQ 10,25

LEGENDA - LEGEND - LEGENDA

1 mq 1 sq. m 1 mc	Linea perimetrale Perimetral line Linea perimetral	Linea d'angolo Corner line Línea de ángulo	Basamento Support Soporte	Piastra dimensioni variabili Slab with variable dimensions Losa de medidas variables
-------------------------	--	--	---------------------------------	--

I quantitativi possono variare in funzione dell'area da pavimentare.
 Quantities can varied based on the geometry of the area to be paved.
 Las cantidades pueden variar de acuerdo con la zona que se deba solar.

FORMATO QUADRATO CON BASAMENTO POSATO SUGLI ANGOLI E CENTRALE
SQUARE SHAPED PAVER WITH SUPPORT PLACED CENTRAL AND ON THE CORNERS
FORMATO CUADRADO CON SOPORTE COLOCADO EN LAS ESQUINAS Y CENTRAL



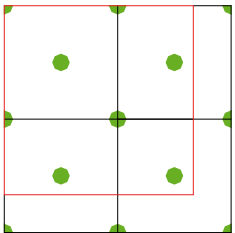
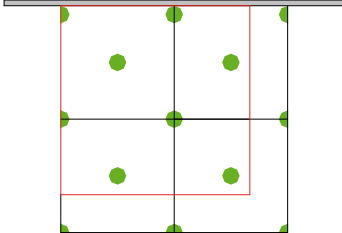
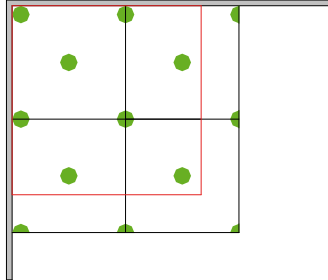

60 x 60 cm

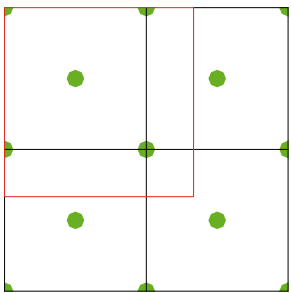
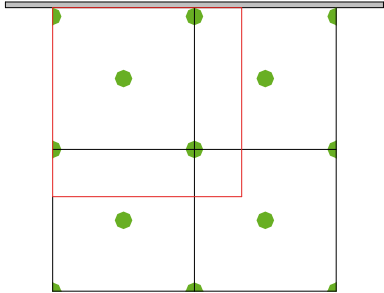
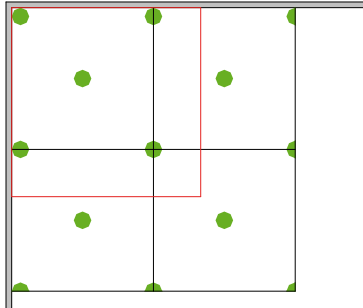
CENTRALI - CENTRAL - CENTRALES	PERIMETRALI - PERIMETRAL - PERIMETRALES	ANGOLARI - ANGULAR - ANGULARES
		
PZ/MQ 5,55	PZ/MQ 6,25	PZ/MQ 7,12

75 x 75 cm

CENTRALI - CENTRAL - CENTRALES	PERIMETRALI - PERIMETRAL - PERIMETRALES	ANGOLARI - ANGULAR - ANGULARES
		
PZ/MQ 3,56	PZ/MQ 4	PZ/MQ 4,56

LEGENDA - LEGEND - LEGENDA

 1 mq 1 sq. m 1 mc	 Linea perimetrale Perimetral line Linea perimetral	 Linea d'angolo Corner line Linea de ángulo	 Basamento Support Soporte	 Piastra dimensioni variabili Slab with variable dimensions Losas de medidas variables
---	--	--	---	---

I quantitativi possono variare in funzione dell'area da pavimentare.
 Quantities can varied based on the geometry of the area to be paved.
 Las cantidades pueden variar de acuerdo con la zona que se deba solar.

FORMATO QUADRATO CON BASAMENTO POSATO SUGLI ANGOLI E CENTRALE
SQUARE SHAPED PAVER WITH SUPPORT PLACED CENTRAL AND ON THE CORNERS
FORMATO CUADRADO CON SOPORTE COLOCADO EN LAS ESQUINAS Y CENTRAL



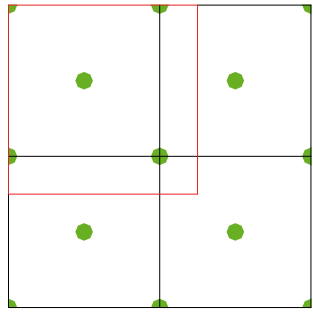
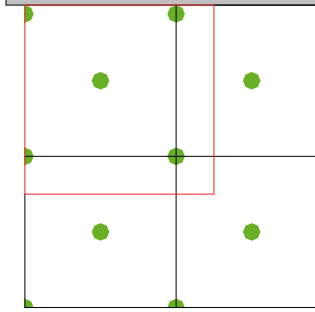
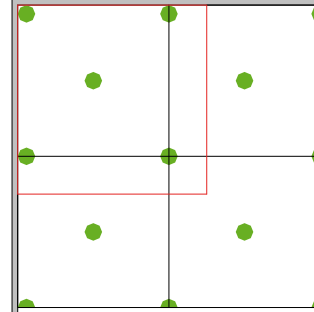

80 x 80 cm

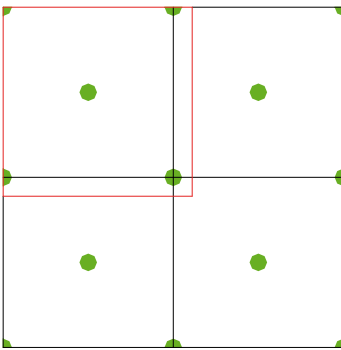
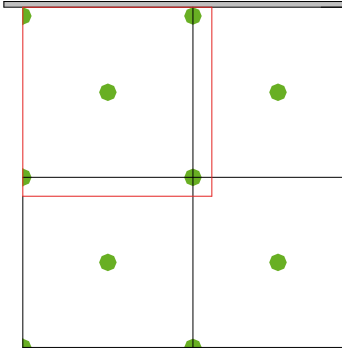
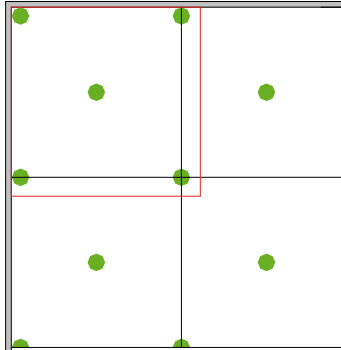
CENTRALI - CENTRAL - CENTRALES	PERIMETRALI - PERIMETRAL - PERIMETRALES	ANGOLARI - ANGULAR - ANGULARES
		
PZ/MQ 3,13	PZ/MQ 3,52	PZ/MQ 4

90 x 90 cm

CENTRALI - CENTRAL - CENTRALES	PERIMETRALI - PERIMETRAL - PERIMETRALES	ANGOLARI - ANGULAR - ANGULARES
		
PZ/MQ 2,47	PZ/MQ 2,78	PZ/MQ 3,16

LEGENDA - LEGEND - LEGENDA

 1 mq 1 sq. m 1 mc	 Linea perimetrale Perimetral line Linea perimetral	 Linea d'angolo Corner line Linea de ángulo	 Basamento Support Soporte	 Piastra dimensioni variabili Slab with variable dimensions Losa de medidas variables
---	--	--	---	--



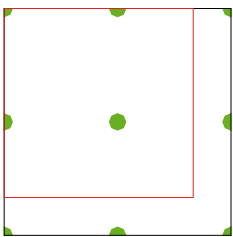
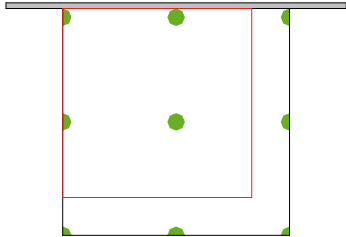
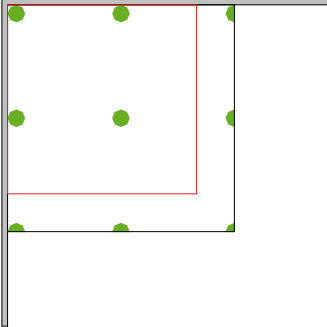

I quantitativi possono variare in funzione dell'area da pavimentare.
 Quantities can varied based on the geometry of the area to be paved.
 Las cantidades pueden variar de acuerdo con la zona que se deba solar.

FORMATO QUADRATO CON BASAMENTO POSATO SUGLI ANGOLI E CENTRALE
SQUARE SHAPED PAVER WITH SUPPORT PLACED CENTRAL AND ON THE CORNERS
FORMATO CUADRADO CON SOPORTE COLOCADO EN LAS ESQUINAS Y CENTRAL

120 x 120 cm

CENTRALI - CENTRAL - CENTRALES	PERIMETRALI - PERIMETRAL - PERIMETRALES	ANGOLARI - ANGULAR - ANGULARES
		
PZ/MQ 2,78	PZ/MQ 3,47	PZ/MQ 4,34

LEGENDA - LEGEND - LEGENDA

 1 mq 1 sq. m 1 mc	 Linea perimetrale Perimetral line Linea perimetral	 Linea d'angolo Corner line Linea de ángulo	 Basamento Support Soporte	 Piastra dimensioni variabili Slab with variable dimensions Losa de medidas variables
---	--	--	---	--

I quantitativi possono variare in funzione dell'area da pavimentare.
 Quantities can varied based on the geometry of the area to be paved.
 Las cantidades pueden variar de acuerdo con la zona que se deba solar.

FORMATO RETTANGOLARE POSA APPAIATA CON BASAMENTO POSATO SUGLI ANGOLI
RECTANGULAR SHAPED PAVER - PAIRED LAYING - WITH SUPPORT PLACED ON THE CORNERS
FORMATO RECTANGULAR COLOCACIÓN JUNTA CORRIDA CON SOPORTE COLOCADO EN LAS ESQUINAS

30 x 35 cm

CENTRALI - CENTRAL - CENTRALES	PERIMETRALI - PERIMETRAL - PERIMETRALES	ANGOLARI - ANGULAR - ANGULARES
PZ/MQ 9,52	PZ/MQ 10,71	PZ/MQ 12,5

35 x 40 cm

CENTRALI - CENTRAL - CENTRALES	PERIMETRALI - PERIMETRAL - PERIMETRALES	ANGOLARI - ANGULAR - ANGULARES
PZ/MQ 7,14	PZ/MQ 8,33	PZ/MQ 9,72

LEGENDA - LEGEND - LEGENDA

1 mq 1 sq. m 1 mc	Linea perimetrale Perimetral line Linea perimetral	Linea d'angolo Corner line Línea de ángulo	Basamento Support Soporte	Piastra dimensioni variabili Slab with variable dimensions Losa de medidas variables
-------------------------	--	--	---------------------------------	--

I quantitativi possono variare in funzione dell'area da pavimentare.
 Quantities can varied based on the geometry of the area to be paved.
 Las cantidades pueden variar de acuerdo con la zona que se deba solar.

FORMATO RETTANGOLARE POSA APPAIATA CON BASAMENTO POSATO SUGLI ANGOLI
RECTANGULAR SHAPED PAVER - PAIRED LAYING - WITH SUPPORT PLACED ON THE CORNERS
FORMATO RECTANGULAR COLOCACIÓN JUNTA CORRIDA CON SOPORTE COLOCADO EN LAS ESQUINAS



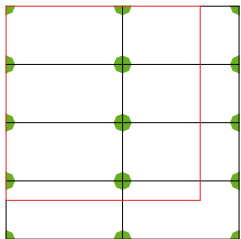
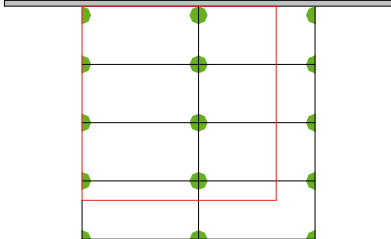
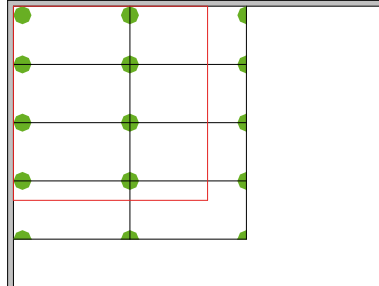

30 x 60 cm

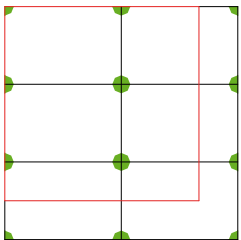
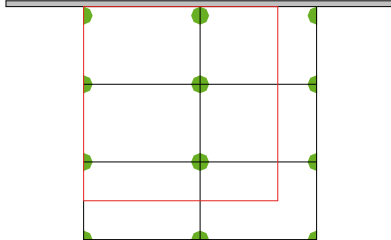
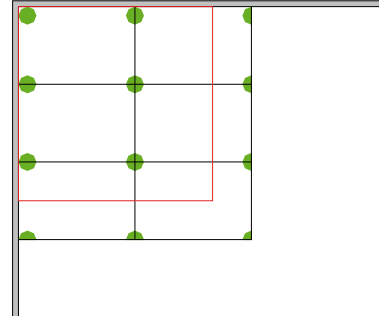
CENTRALI - CENTRAL - CENTRALES	PERIMETRALI - PERIMETRAL - PERIMETRALES	ANGOLARI - ANGULAR - ANGULARES
		
PZ/MQ 5,56	PZ/MQ 6,25	PZ/MQ 7,81

40 x 60 cm

CENTRALI - CENTRAL - CENTRALES	PERIMETRALI - PERIMETRAL - PERIMETRALES	ANGOLARI - ANGULAR - ANGULARES
		
PZ/MQ 4,17	PZ/MQ 4,86	PZ/MQ 6,08

LEGENDA - LEGEND - LEGENDA

 1 mq 1 sq. m 1 mc	Linea perimetrale Perimetral line Linea perimetral	 Linea d'angolo Corner line Linea de ángulo	 Basamento Support Soporte	 Piastra dimensioni variabili Slab with variable dimensions Losa de medidas variables
---	--	--	---	--

I quantitativi possono variare in funzione dell'area da pavimentare.
 Quantities can varied based on the geometry of the area to be paved.
 Las cantidades pueden variar de acuerdo con la zona que se deba solar.

FORMATO RETTANGOLARE POSA APPAIATA CON BASAMENTO POSATO SUGLI ANGOLI
RECTANGULAR SHAPED PAVER - PAIRED LAYING - WITH SUPPORT PLACED ON THE CORNERS
FORMATO RECTANGULAR COLOCACIÓN JUNTA CORRIDA CON SOPORTE COLOCADO EN LAS ESQUINAS

40 x 80 cm

CENTRALI - CENTRAL - CENTRALES	PERIMETRALI - PERIMETRAL - PERIMETRALES	ANGOLARI - ANGULAR - ANGULARES
PZ/MQ 3,13	PZ/MQ 3,65	PZ/MQ 4,56

30 x 90 cm

CENTRALI - CENTRAL - CENTRALES	PERIMETRALI - PERIMETRAL - PERIMETRALES	ANGOLARI - ANGULAR - ANGULARES
PZ/MQ 3,7	PZ/MQ 4,17	PZ/MQ 5,21

LEGENDA - LEGEND - LEGENDA

1 mq 1 sq. m 1 mc	Linea perimetrale Perimetral line Linea perimetral	Linea d'angolo Corner line Linea de ángulo	Basamento Support Soporte	Piastra dimensioni variabili Slab with variable dimensions Losa de medidas variables
-------------------------	--	--	---------------------------------	--

I quantitativi possono variare in funzione dell'area da pavimentare.
 Quantities can varied based on the geometry of the area to be paved.
 Las cantidades pueden variar de acuerdo con la zona que se deba solar.

FORMATO RETTANGOLARE POSA APPAIATA CON BASAMENTO POSATO SUGLI ANGOLI
RECTANGULAR SHAPED PAVER - PAIRED LAYING - WITH SUPPORT PLACED ON THE CORNERS
FORMATO RECTANGULAR COLOCACIÓN JUNTA CORRIDA CON SOPORTE COLOCADO EN LAS ESQUINAS

40 x 90 cm

CENTRALI - CENTRAL - CENTRALES	PERIMETRALI - PERIMETRAL - PERIMETRALES	ANGOLARI - ANGULAR - ANGULARES
PZ/MQ 2,78	PZ/MQ 3,24	PZ/MQ 4,05

45 x 90 cm

CENTRALI - CENTRAL - CENTRALES	PERIMETRALI - PERIMETRAL - PERIMETRALES	ANGOLARI - ANGULAR - ANGULARES
PZ/MQ 2,47	PZ/MQ 2,88	PZ/MQ 3,6

LEGENDA - LEGEND - LEGENDA

1 mq 1 sq. m 1 mc	Linea perimetrale Perimetral line Linea perimetral	Linea d'angolo Corner line Linea de ángulo	Basamento Support Soporte	Piastra dimensioni variabili Slab with variable dimensions Losas de medidas variables
-------------------------	--	--	---------------------------------	---

I quantitativi possono variare in funzione dell'area da pavimentare.
 Quantities can varied based on the geometry of the area to be paved.
 Las cantidades pueden variar de acuerdo con la zona que se deba solar.

FORMATO RETTANGOLARE POSA APPAIATA CON BASAMENTO POSATO SUGLI ANGOLI
RECTANGULAR SHAPED PAVER - PAIRED LAYING - WITH SUPPORT PLACED ON THE CORNERS
FORMATO RECTANGULAR COLOCACIÓN JUNTA CORRIDA CON SOPORTE COLOCADO EN LAS ESQUINAS



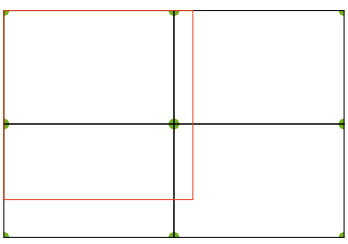
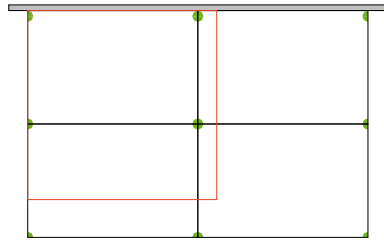
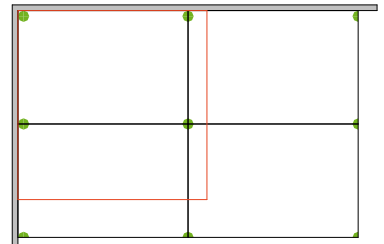

60 x 90 cm

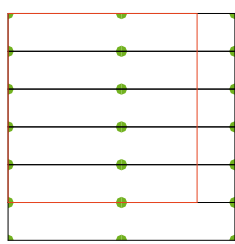
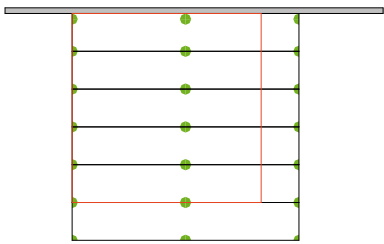
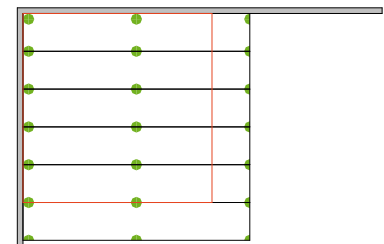
CENTRALI - CENTRAL - CENTRALES	PERIMETRALI - PERIMETRAL - PERIMETRALES	ANGOLARI - ANGULAR - ANGULARES
		
PZ/MQ 1,85	PZ/MQ 2,31	PZ/MQ 2,89

20 x 120 cm

CENTRALI - CENTRAL - CENTRALES	PERIMETRALI - PERIMETRAL - PERIMETRALES	ANGOLARI - ANGULAR - ANGULARES
		
PZ/MQ 8,33	PZ/MQ 9,13	PZ/MQ 11,28

LEGENDA - LEGEND - LEGENDA

 1 mq 1 sq. m 1 mc	 Linea perimetrale Perimetral line Linea perimetral	 Linea d'angolo Corner line Línea de ángulo	 Basamento Support Soporte	 Piastra dimensioni variabili Slab with variable dimensions Losa de medidas variables
---	--	--	---	--

I quantitativi possono variare in funzione dell'area da pavimentare.
 Quantities can varied based on the geometry of the area to be paved.
 Las cantidades pueden variar de acuerdo con la zona que se deba solar.

FORMATO RETTANGOLARE POSA APPAIATA CON BASAMENTO POSATO SUGLI ANGOLI
RECTANGULAR SHAPED PAVER - PAIRED LAYING - WITH SUPPORT PLACED ON THE CORNERS
FORMATO RECTANGULAR COLOCACIÓN JUNTA CORRIDA CON SOPORTE COLOCADO EN LAS ESQUINAS

30 x 120 cm

CENTRALI - CENTRAL - CENTRALES	PERIMETRALI - PERIMETRAL - PERIMETRALES	ANGOLARI - ANGULAR - ANGULARES
PZ/MQ 5,56	PZ/MQ 6,25	PZ/MQ 7,81

40 x 120 cm

CENTRALI - CENTRAL - CENTRALES	PERIMETRALI - PERIMETRAL - PERIMETRALES	ANGOLARI - ANGULAR - ANGULARES
PZ/MQ 4,17	PZ/MQ 4,86	PZ/MQ 6,08

LEGENDA - LEGEND - LEGENDA

1 mq 1 sq. m 1 mc	Linea perimetrale Perimetral line Linea perimetral	Linea d'angolo Corner line Línea de ángulo	Basamento Support Soporte	Piastra dimensioni variabili Slab with variable dimensions Losa de medidas variables
-------------------------	--	--	---------------------------------	--

I quantitativi possono variare in funzione dell'area da pavimentare.
 Quantities can varied based on the geometry of the area to be paved.
 Las cantidades pueden variar de acuerdo con la zona que se deba solar.



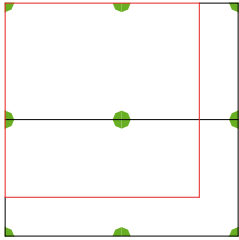
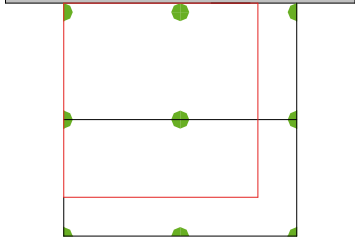
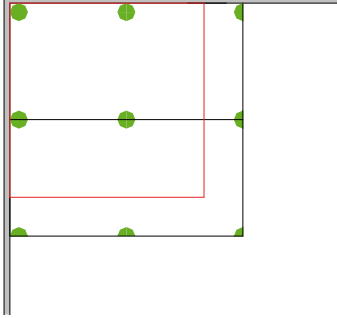

FORMATO RETTANGOLARE POSA APPAIATA CON BASAMENTO POSATO SUGLI ANGOLI
RECTANGULAR SHAPED PAVER - PAIRED LAYING - WITH SUPPORT PLACED ON THE CORNERS
FORMATO RECTANGULAR COLOCACIÓN JUNTA CORRIDA CON SOPORTE COLOCADO EN LAS ESQUINAS

60 x 120 cm

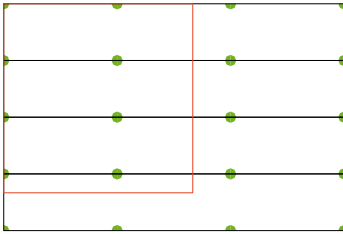
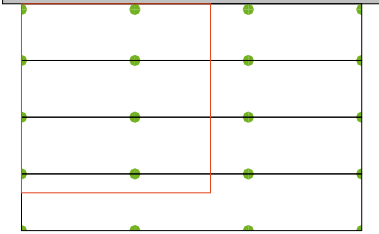
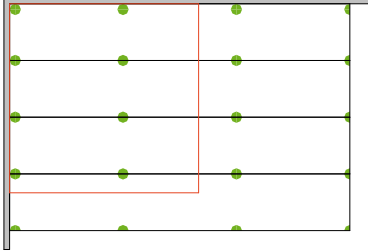
CENTRALI - CENTRAL - CENTRALES	PERIMETRALI - PERIMETRAL - PERIMETRALES	ANGOLARI - ANGULAR - ANGULARES
		
PZ/MQ 2,78	PZ/MQ 3,47	PZ/MQ 4,34

30 x 180 cm

CENTRALI - CENTRAL - CENTRALES	PERIMETRALI - PERIMETRAL - PERIMETRALES	ANGOLARI - ANGULAR - ANGULARES
		
PZ/MQ 5,56	PZ/MQ 6,25	PZ/MQ 7,29

LEGENDA - LEGEND - LEGENDA				
 1 mq 1 sq. m 1 mc	 Linea perimetrale Perimetral line Linea perimetral	 Linea d'angolo Corner line Linea de ángulo	 Basamento Support Soporte	 Piastra dimensioni variabili Slab with variable dimensions Losa de medidas variables

I quantitativi possono variare in funzione dell'area da pavimentare.
 Quantities can varied based on the geometry of the area to be paved.
 Las cantidades pueden variar de acuerdo con la zona que se deba solar.

FORMATO RETTANGOLARE POSA APPAIATA CON BASAMENTO POSATO SUGLI ANGOLI
RECTANGULAR SHAPED PAVER - PAIRED LAYING - WITH SUPPORT PLACED ON THE CORNERS
FORMATO RECTANGULAR COLOCACIÓN JUNTA CORRIDA CON SOPORTE COLOCADO EN LAS ESQUINAS

40 x 180 cm

CENTRALI - CENTRAL - CENTRALES	PERIMETRALI - PERIMETRAL - PERIMETRALES	ANGOLARI - ANGULAR - ANGULARES
PZ/MQ 4,17	PZ/MQ 4,86	PZ/MQ 5,67

LEGENDA - LEGEND - LEGENDA					
	1 mq 1 sq. m 1 mc		Linea perimetrale Perimetral line Linea perimetral		Linea d'angolo Corner line Linea de ángulo
			Basamento Support Soporte		Piastra dimensioni variabili Slab with variable dimensions Losa de medidas variables

I quantitativi possono variare in funzione dell'area da pavimentare.
 Quantities can varied based on the geometry of the area to be paved.
 Las cantidades pueden variar de acuerdo con la zona que se deba solar.

FORMATO RETTANGOLARE POSA SFALSATA CON BASAMENTO POSATO SUGLI ANGOLI
RECTANGULAR SHAPED PAVER - NOT ALIGNED LAYING - WITH SUPPORT PLACED ON THE CORNERS
FORMATO RECTANGULAR COLOCACIÓN A ROMPE JUNTAS CON SOPORTE COLOCADO EN LAS ESQUINAS



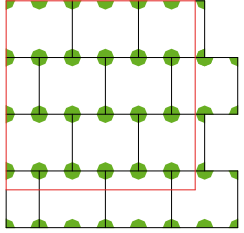
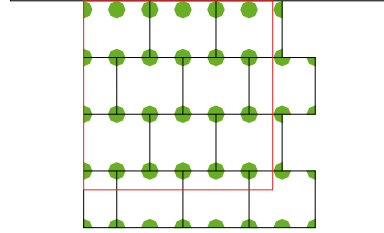
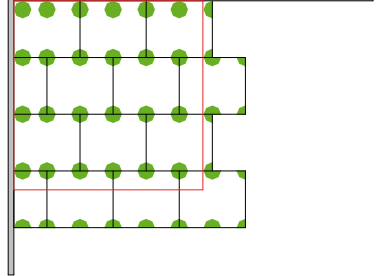

30 x 35 cm

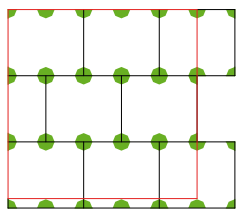
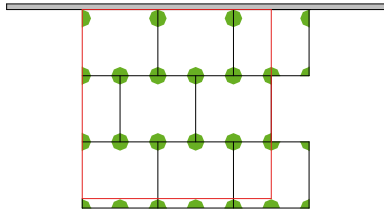
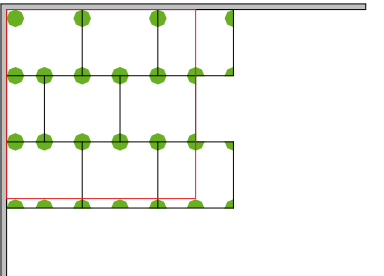
CENTRALI - CENTRAL - CENTRALES	PERIMETRALI - PERIMETRAL - PERIMETRALES	ANGOLARI - ANGULAR - ANGULARES
		
PZ/MQ 19,05	PZ/MQ 21,43	PZ/MQ 22,96

35 x 40 cm

CENTRALI - CENTRAL - CENTRALES	PERIMETRALI - PERIMETRAL - PERIMETRALES	ANGOLARI - ANGULAR - ANGULARES
		
PZ/MQ 14,29	PZ/MQ 16,67	PZ/MQ 18,06

LEGENDA - LEGEND - LEGENDA

 1 mq 1 sq. m 1 mc	 Linea perimetrale Perimetral line Linea perimetral	 Linea d'angolo Corner line Linea de ángulo	 Basamento Support Soporte	 Piastra dimensioni variabili Slab with variable dimensions Losa de medidas variables
---	--	--	---	--

I quantitativi possono variare in funzione dell'area da pavimentare.
 Quantities can varied based on the geometry of the area to be paved.
 Las cantidades pueden variar de acuerdo con la zona que se deba solar.

FORMATO RETTANGOLARE POSA SFALSATA CON BASAMENTO POSATO SUGLI ANGOLI
RECTANGULAR SHAPED PAVER - NOT ALIGNED LAYING - WITH SUPPORT PLACED ON THE CORNERS
FORMATO RECTANGULAR COLOCACIÓN A ROMPE JUNTAS CON SOPORTE COLOCADO EN LAS ESQUINAS

30 x 60 cm

CENTRALI - CENTRAL - CENTRALES	PERIMETRALI - PERIMETRAL - PERIMETRALES	ANGOLARI - ANGULAR - ANGULARES
PZ/MQ 11,11	PZ/MQ 12,50	PZ/MQ 13,75

40 x 60 cm

CENTRALI - CENTRAL - CENTRALES	PERIMETRALI - PERIMETRAL - PERIMETRALES	ANGOLARI - ANGULAR - ANGULARES
PZ/MQ 8,33	PZ/MQ 9,72	PZ/MQ 10,69

LEGENDA - LEGEND - LEGENDA

1 mq 1 sq. m 1 mc	Linea perimetrale Perimetral line Linea perimetral	Linea d'angolo Corner line Linea de ángulo	Basamento Support Soporte	Piastra dimensioni variabili Slab with variable dimensions Losa de medidas variables
-------------------------	--	--	---------------------------------	--

I quantitativi possono variare in funzione dell'area da pavimentare.
 Quantities can varied based on the geometry of the area to be paved.
 Las cantidades pueden variar de acuerdo con la zona que se deba solar.

FORMATO RETTANGOLARE POSA SFALSATA CON BASAMENTO POSATO SUGLI ANGOLI
RECTANGULAR SHAPED PAVER - NOT ALIGNED LAYING - WITH SUPPORT PLACED ON THE CORNERS
FORMATO RECTANGULAR COLOCACIÓN A ROMPE JUNTAS CON SOPORTE COLOCADO EN LAS ESQUINAS

40 x 80 cm

CENTRALI - CENTRAL - CENTRALES	PERIMETRALI - PERIMETRAL - PERIMETRALES	ANGOLARI - ANGULAR - ANGULARES
PZ/MQ 6,25	PZ/MQ 7,29	PZ/MQ 8,20

30 x 90 cm

CENTRALI - CENTRAL - CENTRALES	PERIMETRALI - PERIMETRAL - PERIMETRALES	ANGOLARI - ANGULAR - ANGULARES
PZ/MQ 7,41	PZ/MQ 8,33	PZ/MQ 9,38

LEGENDA - LEGEND - LEGENDA

1 mq 1 sq. m 1 mc	Linea perimetrale Perimetral line Linea perimetral	Linea d'angolo Corner line Línea de ángulo	Basamento Support Soporte	Piastra dimensioni variabili Slab with variable dimensions Losa de medidas variables
-------------------------	--	--	---------------------------------	--

I quantitativi possono variare in funzione dell'area da pavimentare.
 Quantities can varied based on the geometry of the area to be paved.
 Las cantidades pueden variar de acuerdo con la zona que se deba solar.

FORMATO RETTANGOLARE POSA SFALSATA CON BASAMENTO POSATO SUGLI ANGOLI
RECTANGULAR SHAPED PAVER - NOT ALIGNED LAYING - WITH SUPPORT PLACED ON THE CORNERS
FORMATO RECTANGULAR COLOCACIÓN A ROMPE JUNTAS CON SOPORTE COLOCADO EN LAS ESQUINAS

40 x 90 cm

CENTRALI - CENTRAL - CENTRALES	PERIMETRALI - PERIMETRAL - PERIMETRALES	ANGOLARI - ANGULAR - ANGULARES
PZ/MQ 5,56	PZ/MQ 6,48	PZ/MQ 7,29

45 x 90 cm

CENTRALI - CENTRAL - CENTRALES	PERIMETRALI - PERIMETRAL - PERIMETRALES	ANGOLARI - ANGULAR - ANGULARES
PZ/MQ 4,94	PZ/MQ 5,76	PZ/MQ 6,48

LEGENDA - LEGEND - LEGENDA

1 mq 1 sq. m 1 mc	Linea perimetrale Perimetral line Linea perimetral	Linea d'angolo Corner line Linea de ángulo	Basamento Support Soporte	Piastra dimensioni variabili Slab with variable dimensions Losas de medidas variables
-------------------------	--	--	---------------------------------	---

I quantitativi possono variare in funzione dell'area da pavimentare.
 Quantities can varied based on the geometry of the area to be paved.
 Las cantidades pueden variar de acuerdo con la zona que se deba solar.

FORMATO RETTANGOLARE POSA SFALSATA CON BASAMENTO POSATO SUGLI ANGOLI
RECTANGULAR SHAPED PAVER - NOT ALIGNED LAYING - WITH SUPPORT PLACED ON THE CORNERS
FORMATO RECTANGULAR COLOCACIÓN A ROMPE JUNTAS CON SOPORTE COLOCADO EN LAS ESQUINAS



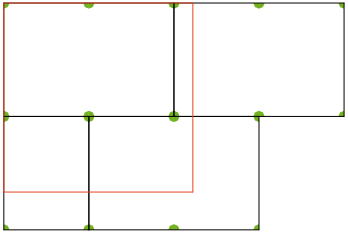
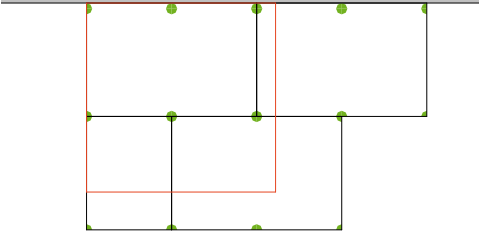
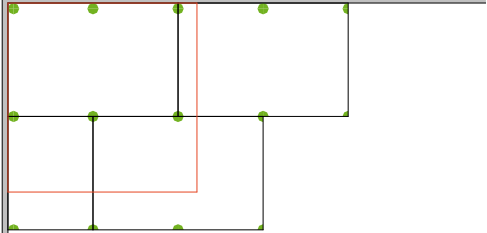

60 x 90 cm

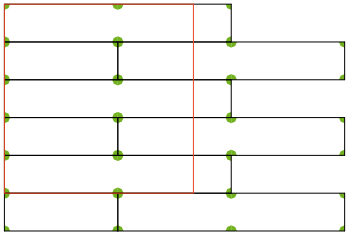
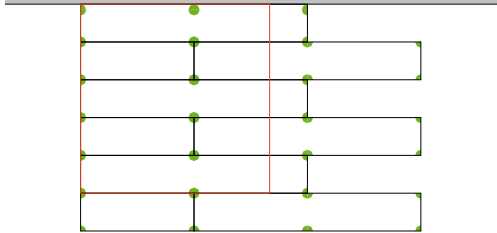
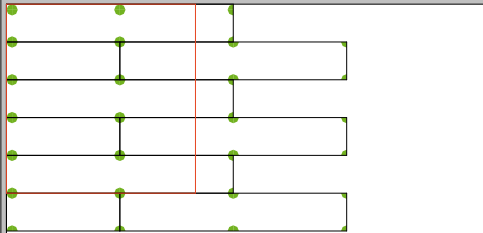
CENTRALI - CENTRAL - CENTRALES	PERIMETRALI - PERIMETRAL - PERIMETRALES	ANGOLARI - ANGULAR - ANGULARES
		
PZ/MQ 3,70	PZ/MQ 4,63	PZ/MQ 5,21

20 x 120 cm

CENTRALI - CENTRAL - CENTRALES	PERIMETRALI - PERIMETRAL - PERIMETRALES	ANGOLARI - ANGULAR - ANGULARES
		
PZ/MQ 8,33	PZ/MQ 9,03	PZ/MQ 10,65

LEGENDA - LEGEND - LEGENDA

 1 mq 1 sq. m 1 mc	 Linea perimetrale Perimetral line Linea perimetral	 Linea d'angolo Corner line Línea de ángulo	 Basamento Support Soporte	 Piastra dimensioni variabili Slab with variable dimensions Losa de medidas variables
---	--	--	---	--

I quantitativi possono variare in funzione dell'area da pavimentare.
 Quantities can varied based on the geometry of the area to be paved.
 Las cantidades pueden variar de acuerdo con la zona que se deba solar.

FORMATO RETTANGOLARE POSA SFALSATA CON BASAMENTO POSATO SUGLI ANGOLI
RECTANGULAR SHAPED PAVER - NOT ALIGNED LAYING - WITH SUPPORT PLACED ON THE CORNERS
FORMATO RECTANGULAR COLOCACIÓN A ROMPE JUNTAS CON SOPORTE COLOCADO EN LAS ESQUINAS



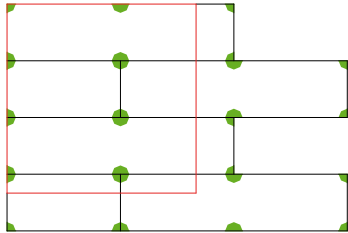
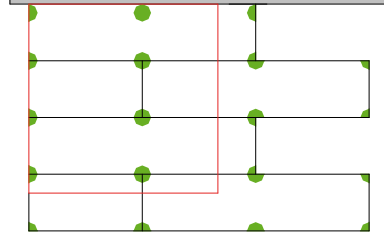
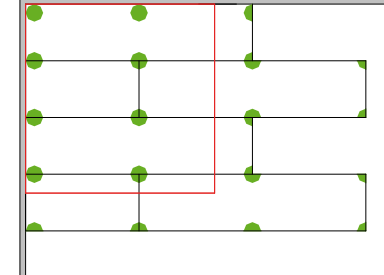

30 x 120 cm

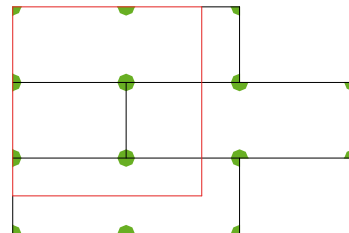
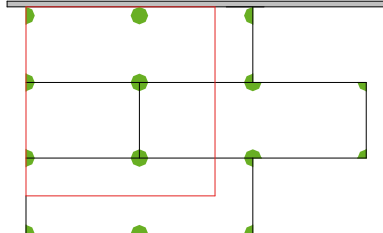
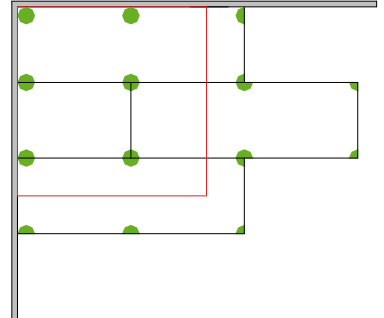
CENTRALI - CENTRAL - CENTRALES	PERIMETRALI - PERIMETRAL - PERIMETRALES	ANGOLARI - ANGULAR - ANGULARES
		
PZ/MQ 5,56	PZ/MQ 6,11	PZ/MQ 7,36

40 x 120 cm

CENTRALI - CENTRAL - CENTRALES	PERIMETRALI - PERIMETRAL - PERIMETRALES	ANGOLARI - ANGULAR - ANGULARES
		
PZ/MQ 4,17	PZ/MQ 4,76	PZ/MQ 5,8

LEGENDA - LEGEND - LEGENDA

 1 mq 1 sq. m 1 mc	 Linea perimetrale Perimetral line Linea perimetral	 Linea d'angolo Corner line Linea de ángulo	 Basamento Support Soporte	 Piastra dimensioni variabili Slab with variable dimensions Losas de medidas variables
---	--	--	---	---

I quantitativi possono variare in funzione dell'area da pavimentare.
 Quantities can varied based on the geometry of the area to be paved.
 Las cantidades pueden variar de acuerdo con la zona que se deba solar.

FORMATO RETTANGOLARE POSA SFALSATA CON BASAMENTO POSATO SUGLI ANGOLI
RECTANGULAR SHAPED PAVER - NOT ALIGNED LAYING - WITH SUPPORT PLACED ON THE CORNERS
FORMATO RECTANGULAR COLOCACIÓN A ROMPE JUNTAS CON SOPORTE COLOCADO EN LAS ESQUINAS



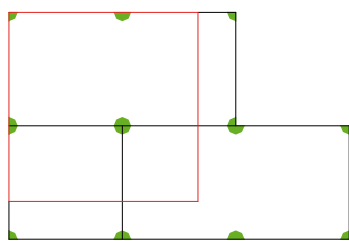
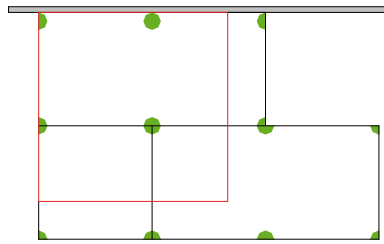
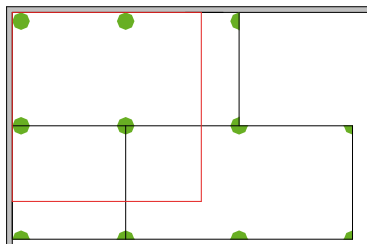

60 x 120 cm

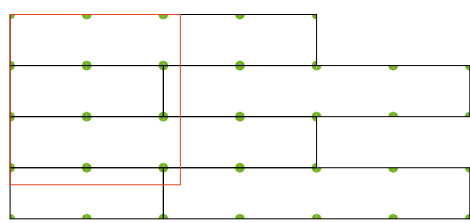
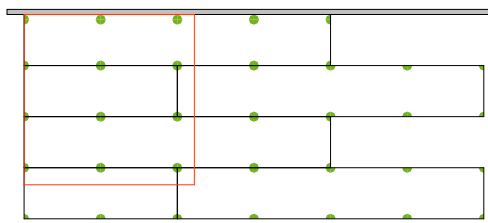
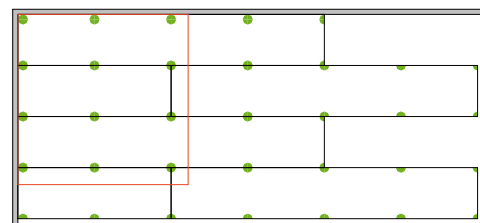
CENTRALI - CENTRAL - CENTRALES	PERIMETRALI - PERIMETRAL - PERIMETRALES	ANGOLARI - ANGULAR - ANGULARES
		
PZ/MQ 2,78	PZ/MQ 3,33	PZ/MQ 4,03

30 x 180 cm

CENTRALI - CENTRAL - CENTRALES	PERIMETRALI - PERIMETRAL - PERIMETRALES	ANGOLARI - ANGULAR - ANGULARES
		
PZ/MQ 7,41	PZ/MQ 8,33	PZ/MQ 9,03

LEGENDA - LEGEND - LEGENDA





 1 mq 1 sq. m 1 mc	 Linea perimetrale Perimetral line Linea perimetral	 Linea d'angolo Corner line Linea de ángulo	 Basamento Support Soporte	 Piastra dimensioni variabili Slab with variable dimensions Losa de medidas variables
---	--	--	---	--

I quantitativi possono variare in funzione dell'area da pavimentare.
 Quantities can varied based on the geometry of the area to be paved.
 Las cantidades pueden variar de acuerdo con la zona que se deba solar.

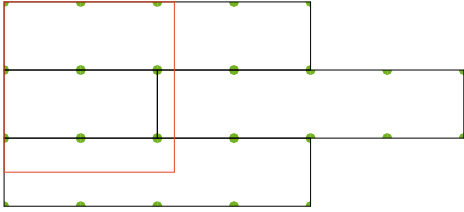
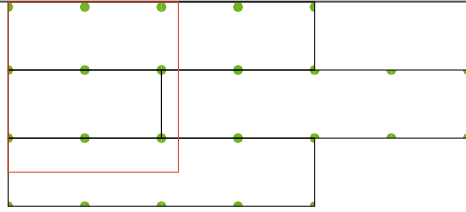
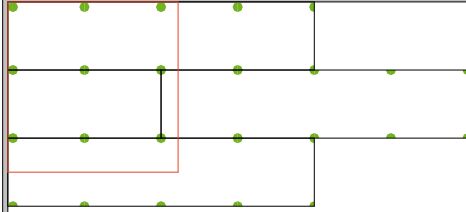
FORMATO RETTANGOLARE POSA SFALSATA CON BASAMENTO POSATO SUGLI ANGOLI
RECTANGULAR SHAPED PAVER - NOT ALIGNED LAYING - WITH SUPPORT PLACED ON THE CORNERS
FORMATO RECTANGULAR COLOCACIÓN A ROMPE JUNTAS CON SOPORTE COLOCADO EN LAS ESQUINAS

40 x 180 cm

CENTRALI - CENTRAL - CENTRALES	PERIMETRALI - PERIMETRAL - PERIMETRALES	ANGOLARI - ANGULAR - ANGULARES
		
PZ/MQ 5,56	PZ/MQ 6,48	PZ/MQ 7,02

LEGENDA - LEGEND - LEGENDA									
	1 mq 1 sq. m 1 mc		Linea perimetrale Perimetral line Linea perimetral		Linea d'angolo Corner line Linea de ángulo		Basamento Support Soporte		Piastra dimensioni variabili Slab with variable dimensions Losa de medidas variables

I quantitativi possono variare in funzione dell'area da pavimentare.
 Quantities can varied based on the geometry of the area to be paved.
 Las cantidades pueden variar de acuerdo con la zona que se deba solar.

FORMATO RETTANGOLARE POSA APPAIATA BASAMENTO POSATO SUGLI ANGOLI E CENTRALE
RECTANGULAR SHAPED PAVER - PAIRED LAYING - WITH SUPPORT PLACED CENTRAL AND ON THE CORNERS
FORMATO RECTANGULAR COLOCACIÓN JUNTA CORRIDA SOPORTE COLOCADO EN LAS ESQUINAS Y CENTRAL

30 x 35 cm

CENTRALI - CENTRAL - CENTRALES	PERIMETRALI - PERIMETRAL - PERIMETRALES	ANGOLARI - ANGULAR - ANGULARES
PZ/MQ 19,05	PZ/MQ 20,24	PZ/MQ 22,02

35 x 40 cm

CENTRALI - CENTRAL - CENTRALES	PERIMETRALI - PERIMETRAL - PERIMETRALES	ANGOLARI - ANGULAR - ANGULARES
PZ/MQ 14,29	PZ/MQ 15,48	PZ/MQ 16,87

LEGENDA - LEGEND - LEGENDA

1 mq 1 sq. m 1 mc	Linea perimetrale Perimetral line Linea perimetral	Linea d'angolo Corner line Línea de ángulo	Basamento Support Soporte	Piastra dimensioni variabili Slab with variable dimensions Losa de medidas variables
-------------------------	--	--	---------------------------------	--

I quantitativi possono variare in funzione dell'area da pavimentare.
 Quantities can varied based on the geometry of the area to be paved.
 Las cantidades pueden variar de acuerdo con la zona que se deba solar.

FORMATO RETTANGOLARE POSA APPAIATA BASAMENTO POSATO SUGLI ANGOLI E CENTRALE
RECTANGULAR SHAPED PAVER - PAIRED LAYING - WITH SUPPORT PLACED CENTRAL AND ON THE CORNERS
FORMATO RECTANGULAR COLOCACIÓN JUNTA CORRIDA SOPORTE COLOCADO EN LAS ESQUINAS Y CENTRAL



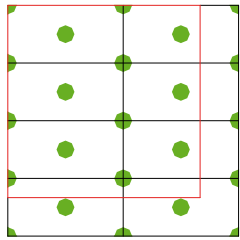
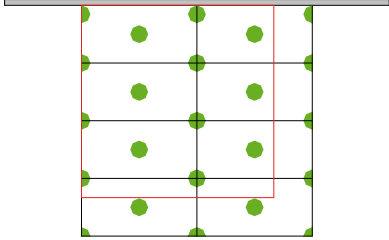
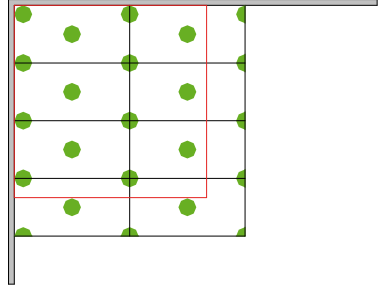

30 x 60 cm

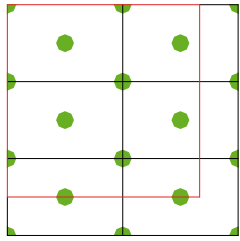
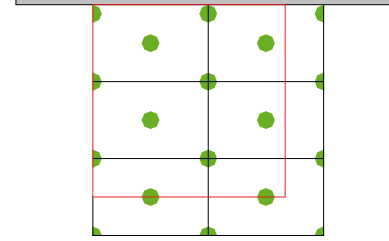
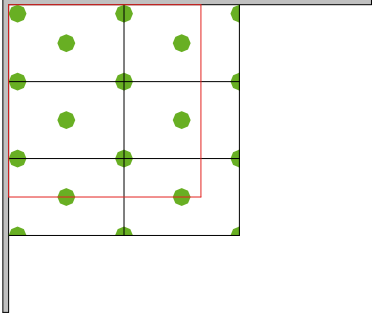
CENTRALI - CENTRAL - CENTRALES	PERIMETRALI - PERIMETRAL - PERIMETRALES	ANGOLARI - ANGULAR - ANGULARES
		
PZ/MQ 11,11	PZ/MQ 11,81	PZ/MQ 13,37

40 x 60 cm

CENTRALI - CENTRAL - CENTRALES	PERIMETRALI - PERIMETRAL - PERIMETRALES	ANGOLARI - ANGULAR - ANGULARES
		
PZ/MQ 8,33	PZ/MQ 9,03	PZ/MQ 10,24

LEGENDA - LEGEND - LEGENDA

 1 mq 1 sq. m 1 mc	 Linea perimetrale Perimetral line Linea perimetral	 Linea d'angolo Corner line Linea de ángulo	 Basamento Support Soporte	 Piastra dimensioni variabili Slab with variable dimensions Losas de medidas variables
---	--	--	---	---

I quantitativi possono variare in funzione dell'area da pavimentare.
 Quantities can varied based on the geometry of the area to be paved.
 Las cantidades pueden variar de acuerdo con la zona que se deba solar.

FORMATO RETTANGOLARE POSA APPAIATA BASAMENTO POSATO SUGLI ANGOLI E CENTRALE
RECTANGULAR SHAPED PAVER - PAIRED LAYING - WITH SUPPORT PLACED CENTRAL AND ON THE CORNERS
FORMATO RECTANGULAR COLOCACIÓN JUNTA CORRIDA SOPORTE COLOCADO EN LAS ESQUINAS Y CENTRAL

40 x 80 cm

CENTRALI - CENTRAL - CENTRALES	PERIMETRALI - PERIMETRAL - PERIMETRALES	ANGOLARI - ANGULAR - ANGULARES
PZ/MQ 6,25	PZ/MQ 6,77	PZ/MQ 7,68

30 x 90 cm

CENTRALI - CENTRAL - CENTRALES	PERIMETRALI - PERIMETRAL - PERIMETRALES	ANGOLARI - ANGULAR - ANGULARES
PZ/MQ 7,41	PZ/MQ 7,87	PZ/MQ 8,91

LEGENDA - LEGEND - LEGENDA

1 mq 1 sq. m 1 mc	Linea perimetrale Perimetral line Linea perimetral	Linea d'angolo Corner line Linea de ángulo	Basamento Support Soporte	Piastra dimensioni variabili Slab with variable dimensions Losa de medidas variables
-------------------------	--	--	---------------------------------	--

I quantitativi possono variare in funzione dell'area da pavimentare.
 Quantities can varied based on the geometry of the area to be paved.
 Las cantidades pueden variar de acuerdo con la zona que se deba solar.

FORMATO RETTANGOLARE POSA APPAIATA BASAMENTO POSATO SUGLI ANGOLI E CENTRALE
RECTANGULAR SHAPED PAVER - PAIRED LAYING - WITH SUPPORT PLACED CENTRAL AND ON THE CORNERS
FORMATO RECTANGULAR COLOCACIÓN JUNTA CORRIDA SOPORTE COLOCADO EN LAS ESQUINAS Y CENTRAL

40 x 90 cm

CENTRALI - CENTRAL - CENTRALES	PERIMETRALI - PERIMETRAL - PERIMETRALES	ANGOLARI - ANGULAR - ANGULARES
PZ/MQ 5,56	PZ/MQ 6,02	PZ/MQ 6,83

45 x 90 cm

CENTRALI - CENTRAL - CENTRALES	PERIMETRALI - PERIMETRAL - PERIMETRALES	ANGOLARI - ANGULAR - ANGULARES
PZ/MQ 4,94	PZ/MQ 5,35	PZ/MQ 6,07

LEGENDA - LEGEND - LEGENDA

1 mq 1 sq. m 1 mc	Linea perimetrale Perimetral line Linea perimetral	Linea d'angolo Corner line Línea de ángulo	Basamento Support Soporte	Piastra dimensioni variabili Slab with variable dimensions Losa de medidas variables
-------------------------	--	--	---------------------------------	--

I quantitativi possono variare in funzione dell'area da pavimentare.
 Quantities can varied based on the geometry of the area to be paved.
 Las cantidades pueden variar de acuerdo con la zona que se deba solar.

FORMATO RETTANGOLARE POSA APPAIATA BASAMENTO POSATO SUGLI ANGOLI E CENTRALE
RECTANGULAR SHAPED PAVER - PAIRED LAYING - WITH SUPPORT PLACED CENTRAL AND ON THE CORNERS
FORMATO RECTANGULAR COLOCACIÓN JUNTA CORRIDA SOPORTE COLOCADO EN LAS ESQUINAS Y CENTRAL

60 x 90 cm

CENTRALI - CENTRAL - CENTRALES	PERIMETRALI - PERIMETRAL - PERIMETRALES	ANGOLARI - ANGULAR - ANGULARES
PZ/MQ 3,70	PZ/MQ 4,17	PZ/MQ 4,75

20 x 120 cm

CENTRALI - CENTRAL - CENTRALES	PERIMETRALI - PERIMETRAL - PERIMETRALES	ANGOLARI - ANGULAR - ANGULARES
PZ/MQ 16,67	PZ/MQ 17,36	PZ/MQ 19,97

LEGENDA - LEGEND - LEGENDA

1 mq 1 sq. m 1 mc	Linea perimetrale Perimetral line Linea perimetral	Linea d'angolo Corner line Línea de ángulo	Basamento Support Soporte	Piastra dimensioni variabili Slab with variable dimensions Losa de medidas variables
-------------------------	--	--	---------------------------------	--

I quantitativi possono variare in funzione dell'area da pavimentare.
 Quantities can varied based on the geometry of the area to be paved.
 Las cantidades pueden variar de acuerdo con la zona que se deba solar.

FORMATO RETTANGOLARE POSA APPAIATA BASAMENTO POSATO SUGLI ANGOLI E CENTRALE
RECTANGULAR SHAPED PAVER - PAIRED LAYING - WITH SUPPORT PLACED CENTRAL AND ON THE CORNERS
FORMATO RECTANGULAR COLOCACIÓN JUNTA CORRIDA SOPORTE COLOCADO EN LAS ESQUINAS Y CENTRAL



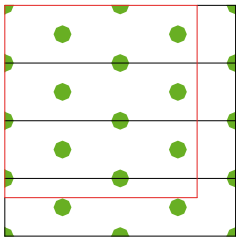
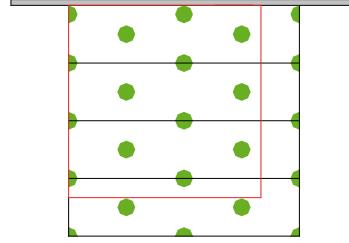
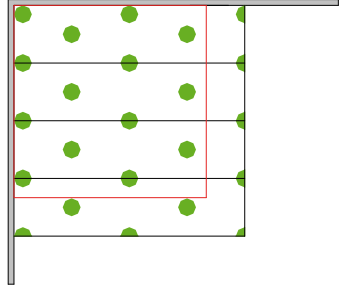

30 x 120 cm

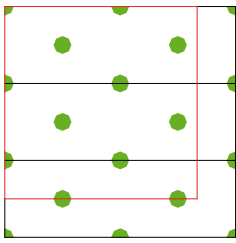
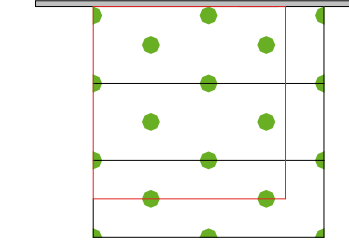
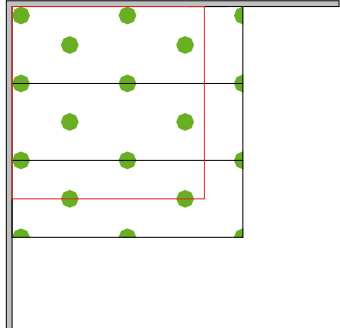
CENTRALI - CENTRAL - CENTRALES	PERIMETRALI - PERIMETRAL - PERIMETRALES	ANGOLARI - ANGULAR - ANGULARES
		
PZ/MQ 11,11	PZ/MQ 11,81	PZ/MQ 13,37

40 x 120 cm

CENTRALI - CENTRAL - CENTRALES	PERIMETRALI - PERIMETRAL - PERIMETRALES	ANGOLARI - ANGULAR - ANGULARES
		
PZ/MQ 8,33	PZ/MQ 9,03	PZ/MQ 10,24

LEGENDA - LEGEND - LEGENDA

 1 mq 1 sq. m 1 mc	 Linea perimetrale Perimetral line Linea perimetral	 Linea d'angolo Corner line Linea de ángulo	 Basamento Support Soporte	 Piastra dimensioni variabili Slab with variable dimensions Losa de medidas variables
---	--	--	---	--

I quantitativi possono variare in funzione dell'area da pavimentare.
 Quantities can varied based on the geometry of the area to be paved.
 Las cantidades pueden variar de acuerdo con la zona que se deba solar.

FORMATO RETTANGOLARE POSA APPAIATA BASAMENTO POSATO SUGLI ANGOLI E CENTRALE
RECTANGULAR SHAPED PAVER - PAIRED LAYING - WITH SUPPORT PLACED CENTRAL AND ON THE CORNERS
FORMATO RECTANGULAR COLOCACIÓN JUNTA CORRIDA SOPORTE COLOCADO EN LAS ESQUINAS Y CENTRAL



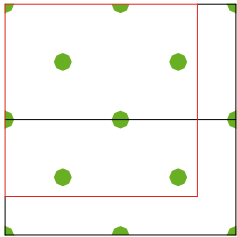
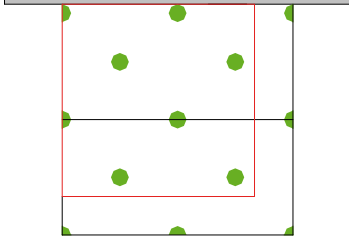
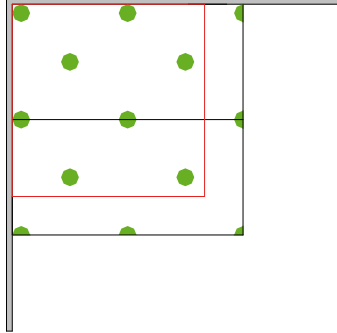

60 x 120 cm

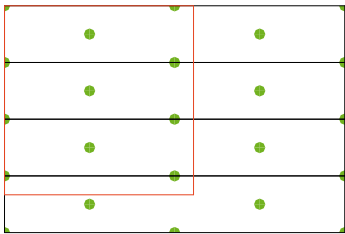
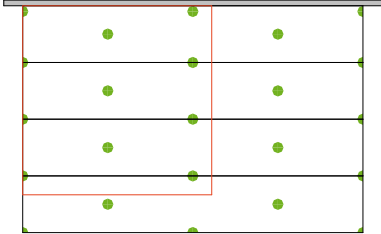
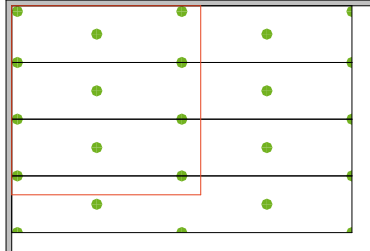
CENTRALI - CENTRAL - CENTRALES	PERIMETRALI - PERIMETRAL - PERIMETRALES	ANGOLARI - ANGULAR - ANGULARES
		
PZ/MQ 5,56	PZ/MQ 6,25	PZ/MQ 7,12

30 x 180 cm

CENTRALI - CENTRAL - CENTRALES	PERIMETRALI - PERIMETRAL - PERIMETRALES	ANGOLARI - ANGULAR - ANGULARES
		
PZ/MQ 7,41	PZ/MQ 7,87	PZ/MQ 8,91

LEGENDA - LEGEND - LEGENDA

 1 mq 1 sq. m 1 mc	 Linea perimetrale Perimetral line Linea perimetral	 Linea d'angolo Corner line Linea de ángulo	 Basamento Support Soporte	 Piastra dimensioni variabili Slab with variable dimensions Losa de medidas variables
---	--	--	---	--

I quantitativi possono variare in funzione dell'area da pavimentare.
 Quantities can varied based on the geometry of the area to be paved.
 Las cantidades pueden variar de acuerdo con la zona que se deba solar.

FORMATO RETTANGOLARE POSA APPAIATA BASAMENTO POSATO SUGLI ANGOLI E CENTRALE
RECTANGULAR SHAPED PAVER - PAIRED LAYING - WITH SUPPORT PLACED CENTRAL AND ON THE CORNERS
FORMATO RECTANGULAR COLOCACIÓN JUNTA CORRIDA SOPORTE COLOCADO EN LAS ESQUINAS Y CENTRAL

40 x 180 cm

CENTRALI - CENTRAL - CENTRALES	PERIMETRALI - PERIMETRAL - PERIMETRALES	ANGOLARI - ANGULAR - ANGULARES
PZ/MQ 5,56	PZ/MQ 6,02	PZ/MQ 6,83

LEGENDA - LEGEND - LEGENDA

	1 mq 1 sq. m 1 mc		Linea perimetrale Perimetral line Linea perimetral		Linea d'angolo Corner line Linea de ángulo		Basamento Support Soporte		Piastra dimensioni variabili Slab with variable dimensions Losa de medidas variables
--	-------------------------	--	--	--	--	--	---------------------------------	--	--

I quantitativi possono variare in funzione dell'area da pavimentare.
 Quantities can varied based on the geometry of the area to be paved.
 Las cantidades pueden variar de acuerdo con la zona que se deba solar.

FORMATO RETTANGOLARE POSA SFALSATA BASAMENTO POSATO SUGLI ANGOLI E CENTRALE
RECTANGULAR SHAPED PAVER - NOT ALIGNED LAYING - WITH SUPPORT PLACED CENTRAL AND ON THE CORNERS
FORMATO RECTANGULAR COLOCACIÓN A ROMPE JUNTAS SOPORTE COLOCADO EN LAS ESQUINAS Y CENTRAL



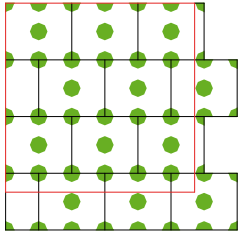
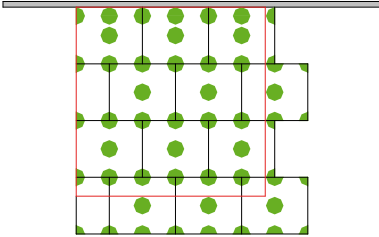
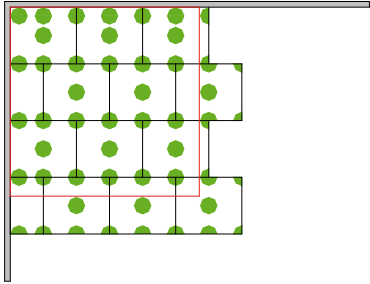

30 x 35 cm

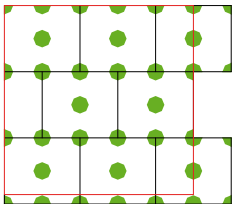
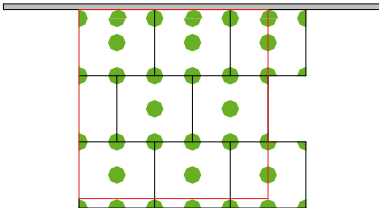
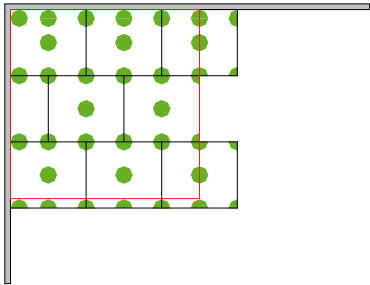
CENTRALI - CENTRAL - CENTRALES	PERIMETRALI - PERIMETRAL - PERIMETRALES	ANGOLARI - ANGULAR - ANGULARES
		
PZ/MQ 28,57	PZ/MQ 30,95	PZ/MQ 32,48

35 x 40 cm

CENTRALI - CENTRAL - CENTRALES	PERIMETRALI - PERIMETRAL - PERIMETRALES	ANGOLARI - ANGULAR - ANGULARES
		
PZ/MQ 21,43	PZ/MQ 23,81	PZ/MQ 25,20

LEGENDA - LEGEND - LEGENDA

 1 mq 1 sq. m 1 mc	 Linea perimetrale Perimetral line Linea perimetral	 Linea d'angolo Corner line Linea de ángulo	 Basamento Support Soporte	 Piastra dimensioni variabili Slab with variable dimensions Losa de medidas variables
---	--	--	---	--

I quantitativi possono variare in funzione dell'area da pavimentare.
 Quantities can varied based on the geometry of the area to be paved.
 Las cantidades pueden variar de acuerdo con la zona que se deba solar.

FORMATO RETTANGOLARE POSA SFALSATA BASAMENTO POSATO SUGLI ANGOLI E CENTRALE
RECTANGULAR SHAPED PAVER - NOT ALIGNED LAYING - WITH SUPPORT PLACED CENTRAL AND ON THE CORNERS
FORMATO RECTANGULAR COLOCACIÓN A ROMPE JUNTAS SOPORTE COLOCADO EN LAS ESQUINAS Y CENTRAL

30 x 60 cm

CENTRALI - CENTRAL - CENTRALES	PERIMETRALI - PERIMETRAL - PERIMETRALES	ANGOLARI - ANGULAR - ANGULARES
PZ/MQ 16,67	PZ/MQ 18,06	PZ/MQ 19,31

40 x 60 cm

CENTRALI - CENTRAL - CENTRALES	PERIMETRALI - PERIMETRAL - PERIMETRALES	ANGOLARI - ANGULAR - ANGULARES
PZ/MQ 12,50	PZ/MQ 13,89	PZ/MQ 14,86

LEGENDA - LEGEND - LEGENDA

1 mq 1 sq. m 1 mc	Linea perimetrale Perimetral line Linea perimetral	Linea d'angolo Corner line Linea de ángulo	Basamento Support Soporte	Piastra dimensioni variabili Slab with variable dimensions Losa de medidas variables
-------------------------	--	--	---------------------------------	--

I quantitativi possono variare in funzione dell'area da pavimentare.
 Quantities can varied based on the geometry of the area to be paved.
 Las cantidades pueden variar de acuerdo con la zona que se deba solar.

FORMATO RETTANGOLARE POSA SFALSATA BASAMENTO POSATO SUGLI ANGOLI E CENTRALE
RECTANGULAR SHAPED PAVER - NOT ALIGNED LAYING - WITH SUPPORT PLACED CENTRAL AND ON THE CORNERS
FORMATO RECTANGULAR COLOCACIÓN A ROMPE JUNTAS SOPORTE COLOCADO EN LAS ESQUINAS Y CENTRAL

40 x 80 cm

CENTRALI - CENTRAL - CENTRALES	PERIMETRALI - PERIMETRAL - PERIMETRALES	ANGOLARI - ANGULAR - ANGULARES
PZ/MQ 9,38	PZ/MQ 10,42	PZ/MQ 11,33

30 x 90 cm

CENTRALI - CENTRAL - CENTRALES	PERIMETRALI - PERIMETRAL - PERIMETRALES	ANGOLARI - ANGULAR - ANGULARES
PZ/MQ 11,11	PZ/MQ 12,04	PZ/MQ 13,08

LEGENDA - LEGEND - LEGENDA

1 mq 1 sq. m 1 mc	Linea perimetrale Perimetral line Linea perimetral	Linea d'angolo Corner line Linea de ángulo	Basamento Support Soporte	Piastra dimensioni variabili Slab with variable dimensions Losa de medidas variables
-------------------------	--	--	---------------------------------	--

I quantitativi possono variare in funzione dell'area da pavimentare.
 Quantities can varied based on the geometry of the area to be paved.
 Las cantidades pueden variar de acuerdo con la zona que se deba solar.

FORMATO RETTANGOLARE POSA SFALSATA BASAMENTO POSATO SUGLI ANGOLI E CENTRALE
RECTANGULAR SHAPED PAVER - NOT ALIGNED LAYING - WITH SUPPORT PLACED CENTRAL AND ON THE CORNERS
FORMATO RECTANGULAR COLOCACIÓN A ROMPE JUNTAS SOPORTE COLOCADO EN LAS ESQUINAS Y CENTRAL

40 x 90 cm

CENTRALI - CENTRAL - CENTRALES	PERIMETRALI - PERIMETRAL - PERIMETRALES	ANGOLARI - ANGULAR - ANGULARES
PZ/MQ 8,33	PZ/MQ 9,26	PZ/MQ 10,07

45 x 90 cm

CENTRALI - CENTRAL - CENTRALES	PERIMETRALI - PERIMETRAL - PERIMETRALES	ANGOLARI - ANGULAR - ANGULARES
PZ/MQ 7,41	PZ/MQ 8,23	PZ/MQ 8,95

LEGENDA - LEGEND - LEGENDA

1 mq 1 sq. m 1 mc	Linea perimetrale Perimetral line Linea perimetral	Linea d'angolo Corner line Línea de ángulo	Basamento Support Soporte	Piastra dimensioni variabili Slab with variable dimensions Losa de medidas variables
-------------------------	--	--	---------------------------------	--

I quantitativi possono variare in funzione dell'area da pavimentare.
 Quantities can varied based on the geometry of the area to be paved.
 Las cantidades pueden variar de acuerdo con la zona que se deba solar.

FORMATO RETTANGOLARE POSA SFALSATA BASAMENTO POSATO SUGLI ANGOLI E CENTRALE
RECTANGULAR SHAPED PAVER - NOT ALIGNED LAYING - WITH SUPPORT PLACED CENTRAL AND ON THE CORNERS
FORMATO RECTANGULAR COLOCACIÓN A ROMPE JUNTAS SOPORTE COLOCADO EN LAS ESQUINAS Y CENTRAL

60 x 90 cm

CENTRALI - CENTRAL - CENTRALES	PERIMETRALI - PERIMETRAL - PERIMETRALES	ANGOLARI - ANGULAR - ANGULARES
PZ/MQ 4,40	PZ/MQ 6,48	PZ/MQ 6,60

20 x 120 cm

CENTRALI - CENTRAL - CENTRALES	PERIMETRALI - PERIMETRAL - PERIMETRALES	ANGOLARI - ANGULAR - ANGULARES
PZ/MQ 16,67	PZ/MQ 17,36	PZ/MQ 18,98

LEGENDA - LEGEND - LEGENDA

1 mq 1 sq. m 1 mc	Linea perimetrale Perimetral line Linea perimetral	Linea d'angolo Corner line Línea de ángulo	Basamento Support Soporte	Piastra dimensioni variabili Slab with variable dimensions Losa de medidas variables
-------------------------	--	--	---------------------------------	--

I quantitativi possono variare in funzione dell'area da pavimentare.
 Quantities can varied based on the geometry of the area to be paved.
 Las cantidades pueden variar de acuerdo con la zona que se deba solar.

FORMATO RETTANGOLARE POSA SFALSATA BASAMENTO POSATO SUGLI ANGOLI E CENTRALE
RECTANGULAR SHAPED PAVER - NOT ALIGNED LAYING - WITH SUPPORT PLACED CENTRAL AND ON THE CORNERS
FORMATO RECTANGULAR COLOCACIÓN A ROMPE JUNTAS SOPORTE COLOCADO EN LAS ESQUINAS Y CENTRAL

30 x 120 cm

CENTRALI - CENTRAL - CENTRALES	PERIMETRALI - PERIMETRAL - PERIMETRALES	ANGOLARI - ANGULAR - ANGULARES
PZ/MQ 11,11	PZ/MQ 11,67	PZ/MQ 12,92

40 x 120 cm

CENTRALI - CENTRAL - CENTRALES	PERIMETRALI - PERIMETRAL - PERIMETRALES	ANGOLARI - ANGULAR - ANGULARES
PZ/MQ 8,33	PZ/MQ 8,93	PZ/MQ 9,97

LEGENDA - LEGEND - LEGENDA

1 mq 1 sq. m 1 mc	Linea perimetrale Perimetral line Linea perimetral	Linea d'angolo Corner line Linea de ángulo	Basamento Support Soporte	Piastra dimensioni variabili Slab with variable dimensions Losas de medidas variables
-------------------------	--	--	---------------------------------	---

I quantitativi possono variare in funzione dell'area da pavimentare.
 Quantities can varied based on the geometry of the area to be paved.
 Las cantidades pueden variar de acuerdo con la zona que se deba solar.

FORMATO RETTANGOLARE POSA SFALSATA BASAMENTO POSATO SUGLI ANGOLI E CENTRALE
RECTANGULAR SHAPED PAVER - NOT ALIGNED LAYING - WITH SUPPORT PLACED CENTRAL AND ON THE CORNERS
FORMATO RECTANGULAR COLOCACIÓN A ROMPE JUNTAS SOPORTE COLOCADO EN LAS ESQUINAS Y CENTRAL

60 x 120 cm

CENTRALI - CENTRAL - CENTRALES	PERIMETRALI - PERIMETRAL - PERIMETRALES	ANGOLARI - ANGULAR - ANGULARES
PZ/MQ 5,56	PZ/MQ 6,11	PZ/MQ 6,81

30 x 180 cm

CENTRALI - CENTRAL - CENTRALES	PERIMETRALI - PERIMETRAL - PERIMETRALES	ANGOLARI - ANGULAR - ANGULARES
PZ/MQ 7,41	PZ/MQ 7,87	PZ/MQ 8,56

LEGENDA - LEGEND - LEGENDA

1 mq 1 sq. m 1 mc	Linea perimetrale Perimetral line Linea perimetral	Linea d'angolo Corner line Linea de ángulo	Basamento Support Soporte	Piastra dimensioni variabili Slab with variable dimensions Losa de medidas variables
-------------------------	--	--	---------------------------------	--



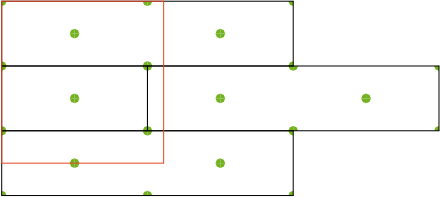
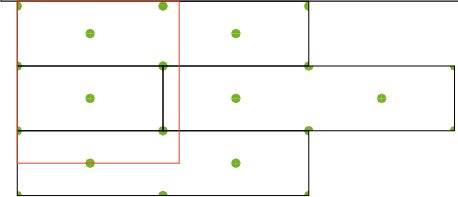
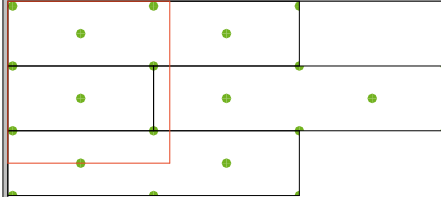

I quantitativi possono variare in funzione dell'area da pavimentare.
 Quantities can varied based on the geometry of the area to be paved.
 Las cantidades pueden variar de acuerdo con la zona que se deba solar.

FORMATO RETTANGOLARE POSA SFALSATA BASAMENTO POSATO SUGLI ANGOLI E CENTRALE
RECTANGULAR SHAPED PAVER - NOT ALIGNED LAYING - WITH SUPPORT PLACED CENTRAL AND ON THE CORNERS
FORMATO RECTANGULAR COLOCACIÓN A ROMPE JUNTAS SOPORTE COLOCADO EN LAS ESQUINAS Y CENTRAL

40 x 180 cm

CENTRALI - CENTRAL - CENTRALES	PERIMETRALI - PERIMETRAL - PERIMETRALES	ANGOLARI - ANGULAR - ANGULARES
		
PZ/MQ 5,56	PZ/MQ 6,02	PZ/MQ 6,56

LEGENDA - LEGEND - LEGENDA

 1 mq 1 sq. m 1 mc	 Linea perimetrale Perimetral line Linea perimetral	 Linea d'angolo Corner line Linea de ángulo	 Basamento Support Soporte	 Piastra dimensioni variabili Slab with variable dimensions Losa de medidas variables
---	--	--	---	--

I quantitativi possono variare in funzione dell'area da pavimentare.
 Quantities can varied based on the geometry of the area to be paved.
 Las cantidades pueden variar de acuerdo con la zona que se deba solar.



ITALPROFILI[®]
RESISTANT TO TIME



CONSUMI A MQ. BASAMENTI REGOLABILI CON FINITURA PAVIMENTAZIONE DECKING

Le seguenti tabelle indicano il fabbisogno a mq dei basamenti regolabili per pavimentazioni sopraelevate con finitura decking.

I conteggi sono stati sviluppati per porzioni di aree da pavimentare:

- Centrali
- Perimetrali
- Angolari

Sono stati considerati interassi di appoggio dei basamenti di 40, 50 e 60 cm. sul travetto, mentre gli interassi tra i travetti di 35, 40, 45 e 50 cm. da verificare secondo le indicazioni del produttore delle doghe della pavimentazione.

CONSUMPTIONS OF ADJUSTABLE PAVING SUPPORTS PER SQM. WITH DECKING FLOORING

The following tables indicate the requirements per square meter of the adjustable paving supports for raised floors with decking.

The calculations have been developed for portions of areas to be paved:

- Central
- Perimetral
- Angular

It has been considered a center distance of the supports of 40, 50 and 60 cm on the joist, while the distance between the joists is 35, 40, 45 and 50 cm. to be verified according to the indications of the manufacturer of the flooring staves.

CONSUMOS POR M2 SOPORTES REGULABLES CON ACABADO PAVIMENTO DE TARIMA

Las siguientes tablas indican las necesidades por m2 de los soportes regulables para suelos elevados con acabados de tarima.

Los recuentos se han desarrollado para parte de áreas que solar:

- Centrales
- Perimetrales
- Angulares

Se han considerado distancias entre ejes de apoyo de los soportes de 40, 50 y 60 cm en la viga, mientras que las distancias entre ejes entre las vigas de 35, 40, 45 y 50 cm se deben comprobar según las indicaciones del fabricante de los listones del pavimento.



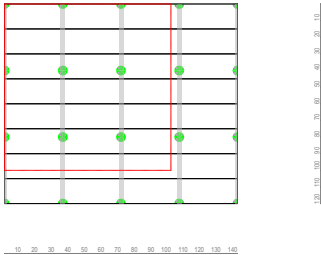
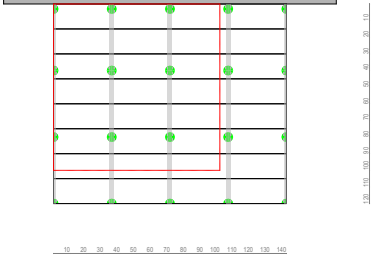
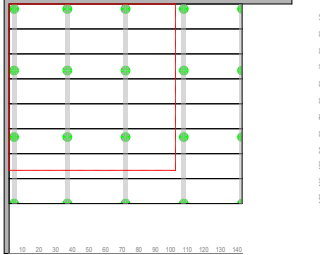

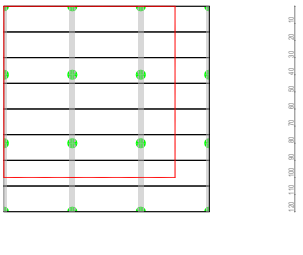
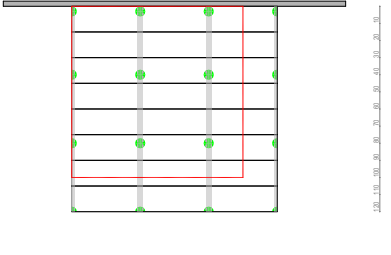
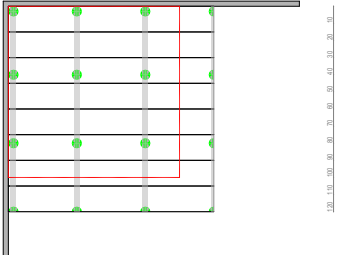

INTERASSE BASAMENTI - CENTER DISTANCE OF SUPPORTS - DISTANCIA ENTRE EJES SOPORTES 40 cm
INTERASSE TRAVETTI - CENTER DISTANCE OF JOISTS - DISTANCIA ENTRE EJES VIGAS 35 cm

<p>CENTRALI CENTRAL CENTRALES</p> <p>numero basamenti al m2 7,14 ml travetto al m2 2,86</p> <p>number of supports per m2 7,14 lm joist per m2 2,86</p> <p>número soportes por m2 7,14 ml viga por m2 2,86</p>	<p>PERIMETRALI PERIMETRAL PERIMETRALES</p> <p>numero basamenti al m2 8,33 ml travetto al m2 2,86</p> <p>number of supports per m2 8,33 lm joist per m2 2,86</p> <p>número soportes por m2 8,33 ml viga por m2 2,86</p>	<p>ANGOLARI ANGULAR ANGULARES</p> <p>numero basamenti al m2 9,38 ml travetto al m2 3,21</p> <p>number of supports per m2 9,38 lm joist per m2 3,21</p> <p>número soportes por m2 9,38 ml viga por m2 3,21</p>
		

INTERASSE BASAMENTI - CENTER DISTANCE OF SUPPORTS - DISTANCIA ENTRE EJES SOPORTES 40 cm
INTERASSE TRAVETTI - CENTER DISTANCE OF JOISTS - DISTANCIA ENTRE EJES VIGAS 40 cm

<p>CENTRALI CENTRAL CENTRALES</p> <p>numero basamenti al m2 6,25 ml travetto al m2 2,50</p> <p>number of supports per m2 6,25 lm joist per m2 2,50</p> <p>número soportes por m2 6,25 ml viga por m2 2,50</p>	<p>PERIMETRALI PERIMETRAL PERIMETRALES</p> <p>numero basamenti al m2 7,29 ml travetto al m2 2,50</p> <p>number of supports per m2 7,29 lm joist per m2 2,50</p> <p>número soportes por m2 7,29 ml viga por m2 2,50</p>	<p>ANGOLARI ANGULAR ANGULARES</p> <p>numero basamenti al m2 8,51 ml travetto al m2 2,92</p> <p>number of supports per m2 8,51 lm joist per m2 2,92</p> <p>número soportes por m2 8,51 ml viga por m2 2,92</p>
		

LEGENDA - LEGEND - LEGENDA

 1 mq 1 sq. m 1 mc	 Basamento Support Soporte	 Travetto Joist Viga	 Linea perimetrale Perimetral line Línea perimetral	 Pavimentazione decking Decking flooring Pavimento de tarima	 Linea d'angolo Corner line Línea de ángulo
---	---	---	--	---	--

I quantitativi possono variare in funzione dell'area da pavimentare.
 Quantities can varied based on the geometry of the area to be paved.
 Las cantidades pueden variar de acuerdo con la zona que se deba solar.

INTERASSE BASAMENTI - CENTER DISTANCE OF SUPPORTS - DISTANCIA ENTRE EJES SOPORTES 40 cm
INTERASSE TRAVETTI - CENTER DISTANCE OF JOISTS - DISTANCIA ENTRE EJES VIGAS 45 cm

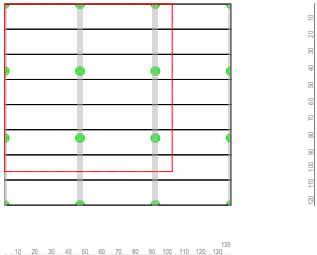
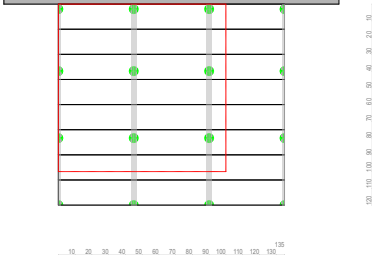
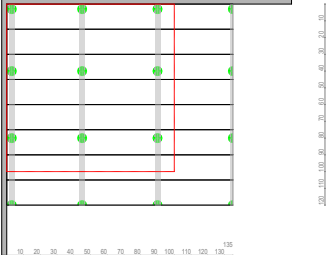
<p>CENTRALI CENTRAL CENTRALES</p> <p>numero basamenti al m2 5,56 ml travetto al m2 2,22</p> <p>number of supports per m2 5,56 lm joist per m2 2,22</p> <p>número soportes por m2 5,56 ml viga por m2 2,22</p>	<p>PERIMETRALI PERIMETRAL PERIMETRALES</p> <p>numero basamenti al m2 6,48 ml travetto al m2 2,22</p> <p>number of supports per m2 6,48 lm joist per m2 2,22</p> <p>número soportes por m2 6,48 ml viga por m2 2,22</p>	<p>ANGOLARI ANGULAR ANGULARES</p> <p>numero basamenti al m2 7,56 ml travetto al m2 2,59</p> <p>number of supports per m2 7,56 lm joist per m2 2,59</p> <p>número soportes por m2 7,56 ml viga por m2 2,59</p>
		

INTERASSE BASAMENTI - CENTER DISTANCE OF SUPPORTS - DISTANCIA ENTRE EJES SOPORTES 40 cm
INTERASSE TRAVETTI - CENTER DISTANCE OF JOISTS - DISTANCIA ENTRE EJES VIGAS 50 cm

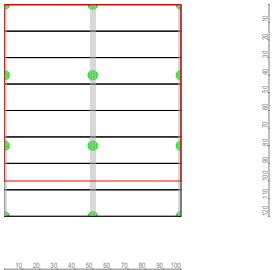
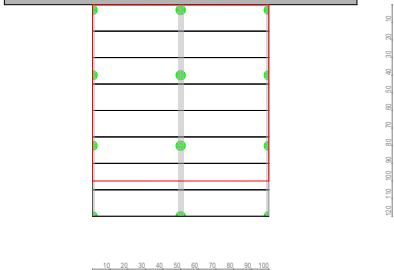
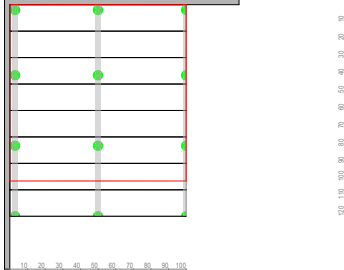
<p>CENTRALI CENTRAL CENTRALES</p> <p>numero basamenti al m2 5,00 ml travetto al m2 2,00</p> <p>number of supports per m2 5,00 lm joist per m2 2,00</p> <p>número soportes por m2 5,00 ml viga por m2 2,00</p>	<p>PERIMETRALI PERIMETRAL PERIMETRALES</p> <p>numero basamenti al m2 5,83 ml travetto al m2 2,00</p> <p>number of supports per m2 5,83 lm joist per m2 2,00</p> <p>número soportes por m2 5,83 ml viga por m2 2,00</p>	<p>ANGOLARI ANGULAR ANGULARES</p> <p>numero basamenti al m2 7,29 ml travetto al m2 2,50</p> <p>number of supports per m2 7,29 lm joist per m2 2,50</p> <p>número soportes por m2 7,29 ml viga por m2 2,50</p>
		

LEGENDA - LEGEND - LEGENDA

<p>1 mq 1 sq. m 1 mc</p>	<p>● Basamento ● Support ● Soporte</p>	<p>— Travetto — Joist — Viga</p>	<p>— Linea perimetrale — Perimetral line — Línea perimetral</p>	<p>▭ Pavimentazione decking ▭ Decking flooring ▭ Pavimento de tarima</p>	<p>└ Linea d'angolo └ Corner line └ Línea de ángulo</p>
----------------------------------	--	--	---	--	---

I quantitativi possono variare in funzione dell'area da pavimentare.
 Quantities can varied based on the geometry of the area to be paved.
 Las cantidades pueden variar de acuerdo con la zona que se deba solar.

INTERASSE BASAMENTI - CENTER DISTANCE OF SUPPORTS - DISTANCIA ENTRE EJES SOPORTES 50 cm
INTERASSE TRAVETTI - CENTER DISTANCE OF JOISTS - DISTANCIA ENTRE EJES VIGAS 35 cm

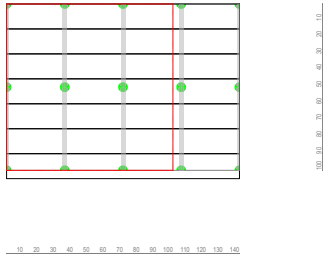
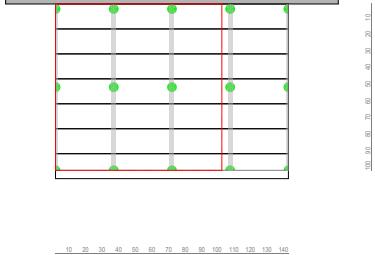
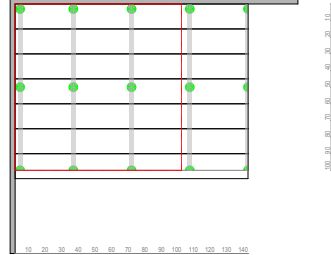
<p>CENTRALI CENTRAL CENTRALES</p> <p>numero basamenti al m2 5,71 ml travetto al m2 2,86</p> <p>number of supports per m2 5,71 lm joist per m2 2,86</p> <p>número soportes por m2 5,71 ml viga por m2 2,86</p>	<p>PERIMETRALI PERIMETRAL PERIMETRALES</p> <p>numero basamenti al m2 7,14 ml travetto al m2 2,86</p> <p>number of supports per m2 7,14 lm joist per m2 2,86</p> <p>número soportes por m2 7,14 ml viga por m2 2,86</p>	<p>ANGOLARI ANGULAR ANGULARES</p> <p>numero basamenti al m2 8,04 ml travetto al m2 3,21</p> <p>number of supports per m2 8,04 lm joist per m2 3,21</p> <p>número soportes por m2 8,04 ml viga por m2 3,21</p>
		

INTERASSE BASAMENTI - CENTER DISTANCE OF SUPPORTS - DISTANCIA ENTRE EJES SOPORTES 50 cm
INTERASSE TRAVETTI - CENTER DISTANCE OF JOISTS - DISTANCIA ENTRE EJES VIGAS 40 cm

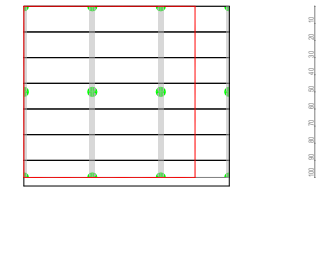
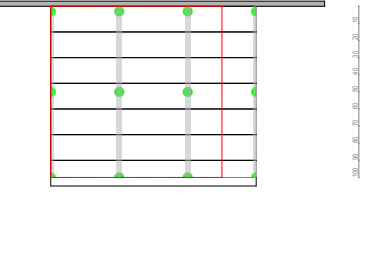
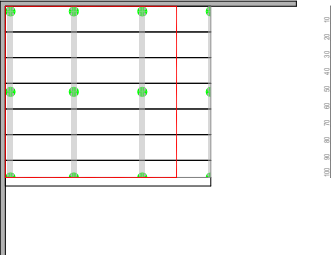
<p>CENTRALI CENTRAL CENTRALES</p> <p>numero basamenti al m2 5,00 ml travetto al m2 2,50</p> <p>number of supports per m2 5,00 lm joist per m2 2,50</p> <p>número soportes por m2 5,00 ml viga por m2 2,50</p>	<p>PERIMETRALI PERIMETRAL PERIMETRALES</p> <p>numero basamenti al m2 6,25 ml travetto al m2 2,50</p> <p>number of supports per m2 6,25 lm joist per m2 2,50</p> <p>número soportes por m2 6,25 ml viga por m2 2,50</p>	<p>ANGOLARI ANGULAR ANGULARES</p> <p>numero basamenti al m2 7,29 ml travetto al m2 2,92</p> <p>number of supports per m2 7,29 lm joist per m2 2,92</p> <p>número soportes por m2 7,29 ml viga por m2 2,92</p>
		

LEGENDA - LEGEND - LEGENDA

 1 mq 1 sq. m 1 mc	 Basamento Support Soporte	 Travetto Joist Viga	 Linea perimetrale Perimetral line Línea perimetral	 Pavimentazione decking Decking flooring Pavimento de tarima	 Linea d'angolo Corner line Línea de ángulo
---	---	---	--	---	--

I quantitativi possono variare in funzione dell'area da pavimentare.
 Quantities can varied based on the geometry of the area to be paved.
 Las cantidades pueden variar de acuerdo con la zona que se deba solar.

INTERASSE BASAMENTI - CENTER DISTANCE OF SUPPORTS - DISTANCIA ENTRE EJES SOPORTES 50 cm INTERASSE TRAVETTI - CENTER DISTANCE OF JOISTS - DISTANCIA ENTRE EJES VIGAS 45 cm

CENTRALI CENTRAL CENTRALES	PERIMETRALI PERIMETRAL PERIMETRALES	ANGOLARI ANGULAR ANGULARES
numero basamenti al m2 4,44 ml travetto al m2 2,22 number of supports per m2 4,44 lm joist per m2 2,22 número soportes por m2 4,44 ml viga por m2 2,22	numero basamenti al m2 5,56 ml travetto al m2 2,22 number of supports per m2 5,56 lm joist per m2 2,22 número soportes por m2 5,56 ml viga por m2 2,22	numero basamenti al m2 6,48 ml travetto al m2 2,59 number of supports per m2 6,48 lm joist per m2 2,59 número soportes por m2 6,48 ml viga por m2 2,59

INTERASSE BASAMENTI - CENTER DISTANCE OF SUPPORTS - DISTANCIA ENTRE EJES SOPORTES 50 cm INTERASSE TRAVETTI - CENTER DISTANCE OF JOISTS - DISTANCIA ENTRE EJES VIGAS 50 cm

CENTRALI CENTRAL CENTRALES	PERIMETRALI PERIMETRAL PERIMETRALES	ANGOLARI ANGULAR ANGULARES
numero basamenti al m2 4,00 ml travetto al m2 2,00 number of supports per m2 4,00 lm joist per m2 2,00 número soportes por m2 4,00 ml viga por m2 2,00	numero basamenti al m2 5,00 ml travetto al m2 2,00 number of supports per m2 5,00 lm joist per m2 2,00 número soportes por m2 5,00 ml viga por m2 2,00	numero basamenti al m2 6,25 ml travetto al m2 2,50 number of supports per m2 6,25 lm joist per m2 2,50 número soportes por m2 6,25 ml viga por m2 2,50

LEGENDA - LEGEND - LEGENDA

	1 mq 1 sq. m 1 mc		Basamento Support Soporte		Travetto Joist Viga		Linea perimetrale Perimetral line Línea perimetral		Pavimentazione decking Decking flooring Pavimento de tarima		Linea d'angolo Corner line Línea de ángulo
--	-------------------------	--	---------------------------------	--	---------------------------	--	--	--	---	--	--

I quantitativi possono variare in funzione dell'area da pavimentare.
 Quantities can varied based on the geometry of the area to be paved.
 Las cantidades pueden variar de acuerdo con la zona que se deba solar.

INTERASSE BASAMENTI - CENTER DISTANCE OF SUPPORTS - DISTANCIA ENTRE EJES SOPORTES 60 cm
INTERASSE TRAVETTI - CENTER DISTANCE OF JOISTS - DISTANCIA ENTRE EJES VIGAS 35 cm

<p>CENTRALI CENTRAL CENTRALES</p> <p>numero basamenti al m2 4,76 ml travetto al m2 2,86</p> <p>number of supports per m2 4,76 lm joist per m2 2,86</p> <p>número soportes por m2 4,76 ml viga por m2 2,86</p>	<p>PERIMETRALI PERIMETRAL PERIMETRALES</p> <p>numero basamenti al m2 5,95 ml travetto al m2 2,86</p> <p>number of supports per m2 5,95 lm joist per m2 2,86</p> <p>número soportes por m2 5,95 ml viga por m2 2,86</p>	<p>ANGOLARI ANGULAR ANGULARES</p> <p>numero basamenti al m2 6,70 ml travetto al m2 3,21</p> <p>number of supports per m2 6,70 lm joist per m2 3,21</p> <p>número soportes por m2 6,70 ml viga por m2 3,21</p>

INTERASSE BASAMENTI - CENTER DISTANCE OF SUPPORTS - DISTANCIA ENTRE EJES SOPORTES 60 cm
INTERASSE TRAVETTI - CENTER DISTANCE OF JOISTS - DISTANCIA ENTRE EJES VIGAS 40 cm

<p>CENTRALI CENTRAL CENTRALES</p> <p>numero basamenti al m2 4,17 ml travetto al m2 2,50</p> <p>number of supports per m2 4,17 lm joist per m2 2,50</p> <p>número soportes por m2 4,17 ml viga por m2 2,50</p>	<p>PERIMETRALI PERIMETRAL PERIMETRALES</p> <p>numero basamenti al m2 5,21 ml travetto al m2 2,50</p> <p>number of supports per m2 5,21 lm joist per m2 2,50</p> <p>número soportes por m2 5,21 ml viga por m2 2,50</p>	<p>ANGOLARI ANGULAR ANGULARES</p> <p>numero basamenti al m2 6,08 ml travetto al m2 2,92</p> <p>number of supports per m2 6,08 lm joist per m2 2,92</p> <p>número soportes por m2 6,08 ml viga por m2 2,92</p>

LEGENDA - LEGEND - LEGENDA

1 mq 1 sq. m 1 mc	Basamento Support Soporte	Travetto Joist Viga	Linea perimetrale Perimetral line Línea perimetral	Pavimentazione decking Decking flooring Pavimento de tarima	Linea d'angolo Corner line Línea de ángulo
-------------------------	---------------------------------	---------------------------	--	---	--

I quantitativi possono variare in funzione dell'area da pavimentare.
 Quantities can varied based on the geometry of the area to be paved.
 Las cantidades pueden variar de acuerdo con la zona que se deba solar.

INTERASSE BASAMENTI - CENTER DISTANCE OF SUPPORTS - DISTANCIA ENTRE EJES SOPORTES 60 cm
INTERASSE TRAVETTI - CENTER DISTANCE OF JOISTS - DISTANCIA ENTRE EJES VIGAS 45 cm

<p>CENTRALI CENTRAL CENTRALES</p> <p>numero basamenti al m2 3,70 ml travetto al m2 2,22</p> <p>number of supports per m2 3,70 lm joist per m2 2,22</p> <p>número soportes por m2 3,70 ml viga por m2 2,22</p>	<p>PERIMETRALI PERIMETRAL PERIMETRALES</p> <p>numero basamenti al m2 4,63 ml travetto al m2 2,22</p> <p>number of supports per m2 4,63 lm joist per m2 2,22</p> <p>número soportes por m2 4,63 ml viga por m2 2,22</p>	<p>ANGOLARI ANGULAR ANGULARES</p> <p>numero basamenti al m2 5,40 ml travetto al m2 2,59</p> <p>number of supports per m2 5,40 lm joist per m2 2,59</p> <p>número soportes por m2 5,40 ml viga por m2 2,59</p>

INTERASSE BASAMENTI - CENTER DISTANCE OF SUPPORTS - DISTANCIA ENTRE EJES SOPORTES 60 cm
INTERASSE TRAVETTI - CENTER DISTANCE OF JOISTS - DISTANCIA ENTRE EJES VIGAS 50 cm

<p>CENTRALI CENTRAL CENTRALES</p> <p>numero basamenti al m2 3,33 ml travetto al m2 2,00</p> <p>number of supports per m2 3,33 lm joist per m2 2,00</p> <p>número soportes por m2 3,33 ml viga por m2 2,00</p>	<p>PERIMETRALI PERIMETRAL PERIMETRALES</p> <p>numero basamenti al m2 4,17 ml travetto al m2 2,00</p> <p>number of supports per m2 4,17 lm joist per m2 2,00</p> <p>número soportes por m2 4,17 ml viga por m2 2,00</p>	<p>ANGOLARI ANGULAR ANGULARES</p> <p>numero basamenti al m2 5,21 ml travetto al m2 2,50</p> <p>number of supports per m2 5,21 lm joist per m2 2,50</p> <p>número soportes por m2 5,21 ml viga por m2 2,50</p>

LEGENDA - LEGEND - LEGENDA

- 1 mq / 1 sq. m / 1 mc
- Basamento / Support / Soporte
- Travetto / Joist / Viga
- Linea perimetrale / Perimetral line / Línea perimetral
- Pavimentazione decking / Decking flooring / Pavimento de tarima
- Linea d'angolo / Corner line / Línea de ángulo

I quantitativi possono variare in funzione dell'area da pavimentare.
 Quantities can varied based on the geometry of the area to be paved.
 Las cantidades pueden variar de acuerdo con la zona que se deba solar.

BASAMENTI PER COPERTURE PIANE CON PIASTRE PREFABBRICATE



FIXED

FIXED PAVING SUPPORTS FOR PREFABRICATED SLABS

SOPORTES PARA CUBIERTAS PLANAS CON LOSAS PREFABRICADAS

Il BASAMENTO ITALPROFILI® in POLIPROPILENE permette di risolvere i problemi che sorgono nella realizzazione delle pavimentazioni. Infatti è costruito principalmente da uno zoccolo di plastica inalterabile che viene posizionato direttamente sul manto. Su questo vengono poggiati successivamente, senza malte o cementanti, i quadroni di pavimentazione. Esso è corredato di guide di posizionamento che impediscono lo slittamento del quadrono stesso e nello stesso tempo, ne sopportano le dilatazioni termiche. La base del supporto in POLIPROPILENE è opportunamente sagomata in modo da permettere facilmente lo scolo delle acque che possono così scorrere direttamente sul manto impermeabile, con l'eliminazione della possibilità di sacche d'acqua.

ITALPROFILI® FIXED SUPPORT quickly and easily resolve problems arising from the installation of a paving system. The support consists of a high resistance base which is placed directly onto the waterproofing cap sheet. The paving slabs are then placed directly onto the supports without the use of concrete or adhesives of any sort. The base is fitted with guides which position and anchor perfectly the paving slabs and which at the same time act as expansion joints. The base of the support is made of HDPE and its shape allows rainwater to drain and flow of easily on the underlying waterproofing membrane, thus also eliminating any chance of ponding caused by the supports themselves trapping water.

El SOPORTE ITALPROFILI® de POLIPROPILENO permite resolver los problemas que surgen en la realización de los suelos. De hecho, está formado principalmente por una base de plástico inalterable que se coloca directamente sobre la membrana. Posteriormente las losas de pavimento se colocan encima de este sin mortero ni cementación. El soporte está equipado con guías de posicionamiento que evitan el deslizamiento de la losa y, al mismo tiempo, soportan las dilataciones térmicas. La base del soporte de POLIPROPILENO tiene una forma adecuada para permitir fácilmente el desagüe del agua que puede fluir directamente sobre la membrana impermeable, eliminando así la posibilidad de que el agua quede estancada.



Art.	61
D	150
H	10

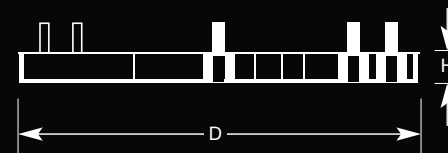

Art.	61.1
D	150
H	15

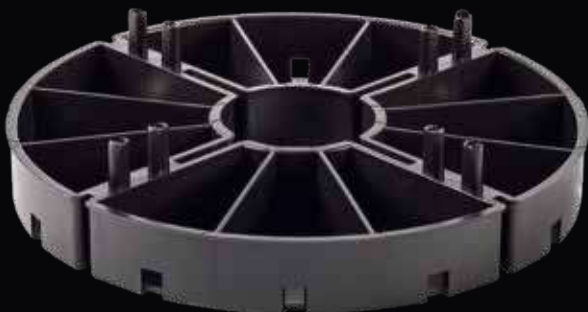
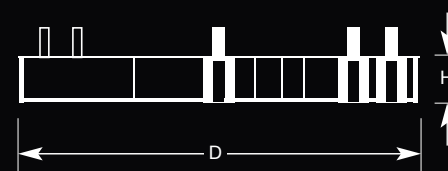

Art.	63.1
D	150
H	20

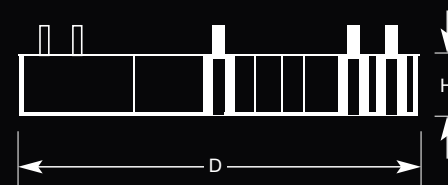

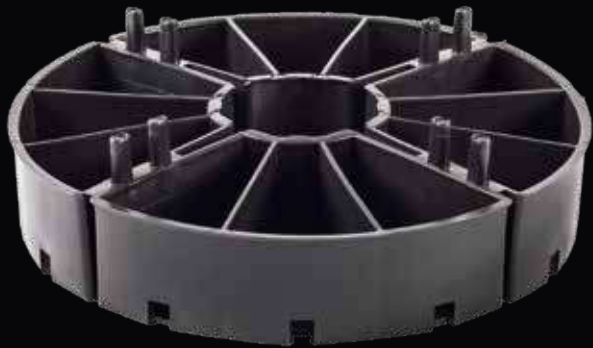

Art. 64.1

Art.	64.1
D	150
H	30

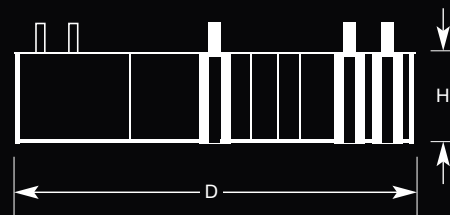

Art. 65

Art.	65
D	150
H	3

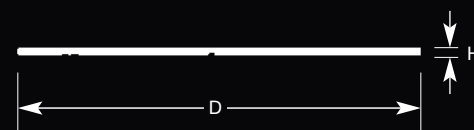

Art. 61.1S

Art.	61.1S
D	175
H	15

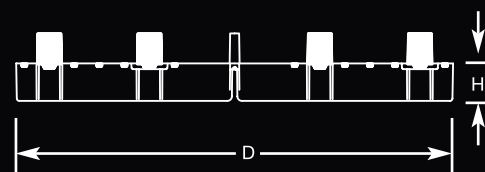

Art. 65S

Art.	65S
D	175
H	3

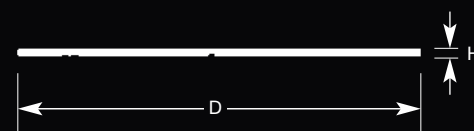

BASAMENTI PER COPERTURE PIANE CON PIASTRE PREFABBRICATE

FIXED PAVING SUPPORTS FOR PREFABRICATED SLABS

SOPORTES PARA CUBIERTAS PLANAS CON LOSAS PREFABRICADAS

Tutti i basamenti ITALPROFILI® sono modulari e sovrapponibili, in modo da consentire il raggiungimento dello spessore (di intercapedine) desiderato, uniformando eventuali difformità planari della superficie con appositi spessori. Lo scopo principale del nuovo basamento è quello di eliminare principalmente le fessurazioni che si possono creare nel manto impermeabile a causa della diversa dilatazione termica subita dalla pavimentazione calpestabile. Inoltre altri vantaggi aggiuntivi, ma non secondari, appaiono il basso costo di posa in opera, la grandissima facilità di rimozione del piano di calpestio in caso di necessaria ispezione al manto sottostante, cosa possibile inoltre senza rottura di alcun quadrone, in ultimo, assicura una certa coibentazione della copertura stessa dovuta all'intercapedine formatasi tra manto e piano di calpestio.

All of the supports are modular and can be stacked so as to achieve the height or thickness of gap underneath the paving desired, and eliminating any unevenness of the roof deck itself. The supports are designed to eliminate cracking and damaging of the waterproofing membrane caused by expansion and contraction of the paving or damage caused by walking on the paving. Over and above these advantages it is also a very quick and cost effective means of installing the paving. The paving can be readily removed and replaced should it become damaged or should inspection of the waterproofing be necessary, without any damage at all. The system also forms an insulation layer of air between the lower surface of the paving and the waterproofing and protects the waterproofing itself from damage by exposure to sunlight. ITALPROFILI® support has been designed to fully interlock when stacking, various heights raised paving can be achieved from 10 mm. upwards. Combinations of supports and leveling shims will allow the gradual increase in raising heights, thereby giving a level finish with all drainage falls under the slabs.

Todos los soportes ITALPROFILI® son modulares y apilables para poder lograr el espesor deseado (del espacio intermedio), uniformando las posibles irregularidades de la superficie con los espesores adecuados. El objetivo principal del nuevo soporte es eliminar principalmente las grietas que se pueden crear en la membrana impermeable debido a la diferente dilatación térmica causada por el suelo practicable. Otras ventajas adicionales, pero no por ello menos importantes, son el bajo costo de instalación, la facilidad de extracción de la superficie practicable en caso de inspección de la membrana, que incluso se puede hacer sin romper ninguna losa, y por último, asegurar un determinado aislamiento de la misma cubierta debido a la cavidad que se forma entre la membrana y la superficie practicable.

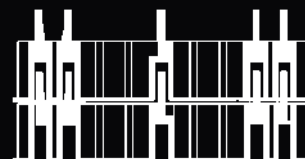
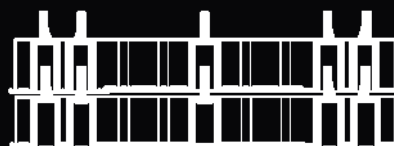
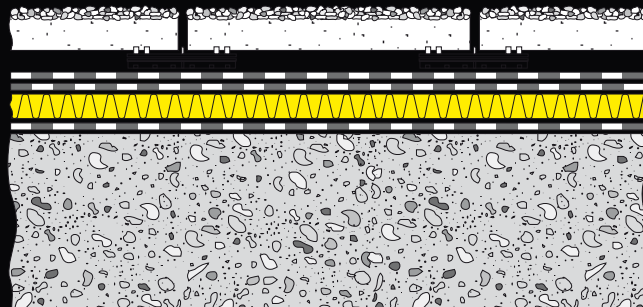

Art. 190

PINZA POSAPIASTRE PER PIASTRE DI LATO 30 - 35 - 40 - 45 - 50 CM
PAVING SLAB HANDLER 30 - 35 - 40 - 45 - 50 CM
PINZA ESPESORADA PARA LOSAS DE 30 - 35 - 40 - 45 - 50 CM DE LADO



Art. 195

VENTOSA ALZAPIASTRELLE 110KG
SUCTION CUP TILE LIFTER 110KG
VENTOSA SUBIDA BALDOSAS 110 KG



ART. 185DP4

DISTANZIALE PERMITRALE INOX FUGA 4 mm

PERIMETRAL SPACER STAINLESS STEEL FOR HEAD SPACER 4 mm

DILATADOR PERIMETRAL ACERO INOX JUNTA 4 mm

Il distanziale perimetrale viene posato direttamente sopra la testa permettendo di tenere distanziata di 5 mm. la pavimentazione dal perimetro verticale di contenimento. Opportunamente sagomato per evitare lo sfregamento della pavimentazione sul perimetro verticale di contenimento ed assorbire eventuali movimenti e dilatazioni della pavimentazione. Realizzato in acciaio inox, spessore di 0,8 mm.

The perimetral spacer is laid directly on the head allowing to keep the flooring of a distance of 5 mm from the vertical containment perimeter. Suitably shaped to avoid the rubbing of the pavement on the vertical containment perimeter and to absorb any movement and expansion of the pavement. Made of stainless steel, 0.8 mm thick.

El dilatador perimetral se coloca directamente sobre la cabeza, permitiendo mantener el pavimento a 5 mm de distancia del perímetro vertical de contención. Tiene una forma adecuada para evitar que el pavimento frote sobre el perímetro vertical de contención y para absorber posibles movimientos y dilataciones del pavimento. Está hecho de acero inoxidable de 0,8 mm de espesor.



bimobject[®]

Download our products
at www.bimobject.com

Puntoffset - Ponte San Nicolò - 500 - 07/2021

GUSELLA-ADV.COM



ITALPROFILI s.r.l.
Via E. Fermi, 2 - 30020 Torre di Mosto (VE) - Italy
Tel. +39 0421 312059 - Fax +39 0421 314586
www.italprofili.com - info@italprofili.com

