

CHANGER

all changer
do are for your family

GLASS SHOWCASE PRODUCTS WORLD

Countertop Display
Standing Display
Cake Display
Deli Showcase

Open Display
Gelato Showcase
Sushi Display
Salad Display

Chest Freezer
Uprigt Showcase
Hot Display
Neutral Display



宁波辰佳电器有限公司
NINGBO CHANGER ELECTRON CO.,LTD

中国浙江省宁波市杭州湾新区兴慈6路317号
Address: 317 Xinci 6 Road, Hangzhouwan District,
Ningbo, Zhejiang Prov., China

Tel: +86-574-63099958, 63590907
Web: www.changerchina.com
Email: nicole@changer-china.com

CHANGER



Global Sales



CHANGER Profile

Established in 1989, Ningbo Changer Electron Co. Ltd has become a large and professional household and commercial appliance company. It covers 400,200 square meters and located in New Hangzhou Bay District, Ningbo City which is one hour and a half away from Shanghai.

Changer has her own top-class research and development teams as well as professional testing equipment. It has 2 factories with annual production capacity of 1.5M refrigerators and freezers, 0.2M showcase and 3.0M electric heaters. Various products are sold not only domestically but also all over the world.

Changer has obtained the certifications of ISO9001 and ISO14001 for its quality management system and environmental controls. All products have passed corresponding certificate such as CE, GS, CB, EMC, UKCA, ETL, NSF and etc.

Changer always keeps stable and healthy growth. In the future she will continue to adhere to the scientific healthy progress and expansion. One industrial pattern featuring diversified industries, large-scale development, professional operation and internationalized business has taken into shape, which is helping to improve the organization structure and management system, and to keep Changer rank among the most valuable electron appliance brands in China even if in the world.

Contents

Company Profile

CHANGER Profile

Products



01 Countertop Display 01-08
桌上型展示柜



02 Standing Display 09-12
立式展示柜



03 Countertop Display 13-24
桌上型展示柜



04 Cake Display 25-32
蛋糕柜



05 Deli Showcase 33-34
熟食柜



06 Open Display 35-46
风幕柜



07 Gelato Showcase 47-50
冰淇淋柜



08 Freezer 51-52
冷冻柜



09 Sushi Display 53-56
寿司柜



10 Salad Display 57-58
沙拉柜



11 Chest Freezer 59-60
冷柜



12 Upright Showcase 61-64
立式展示柜



13 Hot Display 65-74
加热展示柜



14 Neutral Display 75-82
展示柜

REFRIGERATED SHOWCASE

Changer Countertop Display

桌上型展示柜



Standard Features 标准配置

- Internal top LED lighting
- Digital temperature controller and display
- Adjustable PVC coated shelves
- 4 sides double tempered glass
- Maintenance free condenser
- Ventilated cooling system
- Automatic defrost
- Front and Back 2 curved glass door

Options 选配

- Lockable Door
- Adjustable chrome plated shelves
- Brilliant Internal LED illumination on sides

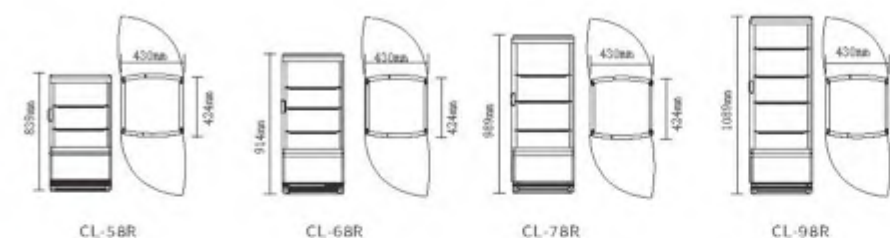

Model	CL-58R	CL-68R	CL-78R	CL-98R
Capacity-Gross(容积)	64L/2.3c.f.	75L/2.6c.f.	86L/3.0c.f.	98L/3.5c.f.
Temperature range(温度)	0-12°C (32-53.6°F)	0-12°C (32-53.6°F)	0-12°C (32-53.6°F)	0-12°C (32-53.6°F)
Refrigerant(制冷剂)	R134a / R290	R134a / R290	R134a / R290	R134a / R290
Climate(气候类型)	4	4	4	4
N.W.(净重)	30kg	31kg	32.5kg	33.5
G.W.(毛重)	32kg	33kg	35kg	36
Overall Dimension(产品尺寸)	430×424×839mm	430×424×914mm	430×424×989mm	430×424×1089mm
Package Dimension(包装尺寸)	480×480×885mm	480×480×960mm	480×480×1035mm	480×480×1135mm
Approval(证书)	CE GS CB UKCA ETL NSF	CE GS CB UKCA ETL NSF	CE GS CB UKCA ETL NSF	CE GS CB UKCA ETL NSF
20" Container(20" F')	88	88	88	88
40" Container (high)(40" F')	276	184	184	184

REFRIGERATED SHOWCASE

Changer Countertop Display

桌上型展示柜-四面风道



Low energy consumption
Simple construction and high security
Air duct outside the glass to remove condensation water



Standard Features 标准配置

- Internal top LED lighting
- Digital temperature controller and display
- Adjustable PVC coated shelves
- 4 sides double tempered glass
- Maintenance free condenser
- Ventilated cooling system
- Automatic defrost
- Air duct outside the glass to remove condensation water

Options 选配

- Lockable Door
- Adjustable chrome plated shelves
- Brilliant Internal LED illumination on sides
- Top light box with LED

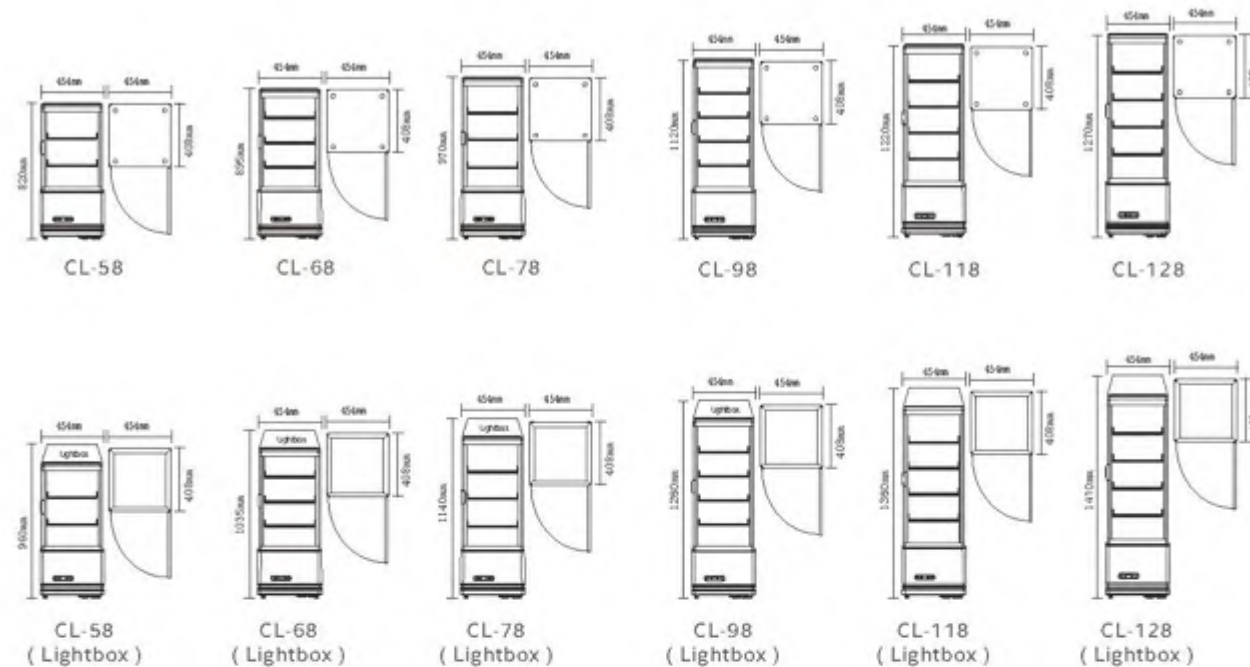

Model	CL-58	CL-68	CL-78
Capacity-Gross(容积)	58L/2.0c.f.	68L/2.4c.f.	78L/2.8c.f.
Temperature range(温度)	0-12°C (32-53.6°F)	0-12°C (32-53.6°F)	0-12°C (32-53.6°F)
Refrigerant(制冷剂)	R134a / R290	R134a / R290	R134a / R290
Climate(气候类型)	4	4	4
N.W.(净重)	32kg	35kg	36kg
G.W.(毛重)	34kg	37kg	38kg
Overall Dimension(产品尺寸)	454×408×820(960)mm	454×408×895(1035)mm	454×408×970(1110)mm
Package Dimension(包装尺寸)	500×455×855mm	500×455×930mm	500×455×1005mm
Approval(证书)	CE GS CB UKCA ETL NSF	CE GS CB UKCA ETL NSF	CE GS CB UKCA ETL NSF
20" Container(20" F')	112	112	112
40" Container (high)(40" F')	351	234	234

Model	CL-98	CL-118	CL-128
Capacity-Gross(容积)	98L/3.5c.f.	118L/4.2c.f.	128L/4.5c.f.
Temperature range(温度)	0-12°C (32-53.6°F)	0-12°C (32-53.6°F)	0-12°C (32-53.6°F)
Refrigerant(制冷剂)	R134a / R290	R134a / R290	R134a / R290
Climate(气候类型)	4	4	4
N.W.(净重)	40kg	42.5kg	43.5kg
G.W.(毛重)	42kg	45.5kg	46.5kg
Overall Dimension(产品尺寸)	454×408×1120(1260)mm	454×408×1220(1360)mm	454×408×1270(1410)mm
Package Dimension(包装尺寸)	500×455×1155mm	500×455×1255mm	500×455×1305mm
Approval(证书)	CE GS CB UKCA ETL NSF	CE GS CB UKCA ETL NSF	CE GS CB UKCA ETL NSF
20" Container(20" F')	112	112	112
40" Container (high)(40" F')	234	234	234

REFRIGERATED SHOWCASE

Changer Countertop Display

桌上型展示柜



Standard Features 标准配置

- Internal top LED lighting
- Digital temperature controller and display
- Adjustable PVC coated shelves
- 4 sides double tempered glass
- Maintenance free condenser
- Ventilated cooling system
- Automatic defrost

Options 选配

- Lockable Door
- Adjustable chrome plated shelves
- Brilliant Internal LED illumination on sides
- Top light box with LED

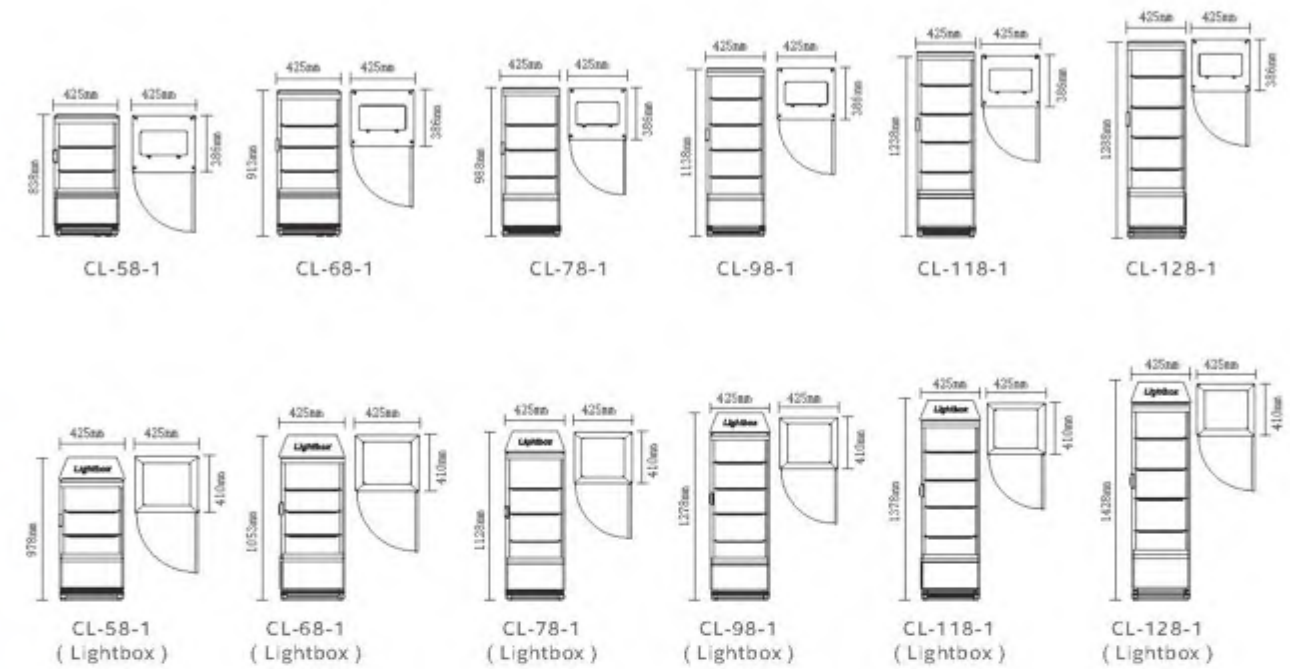

Model	CL-58-1	CL-68-1	CL-78-1
Capacity-Gross(容积)	58L/2.0c.f.	68L/2.4c.f.	78L/2.8c.f.
Temperature range(温度)	0-12°C (32-53.6°F)	0-12°C (32-53.6°F)	0-12°C (32-53.6°F)
Refrigerant(制冷剂)	R134a / R290	R134a / R290	R134a / R290
Climate(气候类型)	4	4	4
N.W.(净重)	30kg	31kg	32.5kg
G.W.(毛重)	32kg	33kg	35kg
Overall Dimension(产品尺寸)	425×380×838(978)mm	425×380×913(1053)mm	425×380×988(1128)mm
Package Dimension(包装尺寸)	470×435×860mm	470×435×935mm	470×435×1010mm
Approval(证书)	CE GS CB UKCA ETL NSF	CE GS CB UKCA ETL NSF	CE GS CB UKCA ETL NSF
20" Container(20" F')	126	126	126
40" Container (high)(40" F')	378	266	266

Model	CL-98-1	CL-118-1	CL-128-1
Capacity-Gross(容积)	98L/3.5c.f.	118L/4.2c.f.	128L/4.5c.f.
Temperature range(温度)	0-12°C (32-53.6°F)	0-12°C (32-53.6°F)	0-12°C (32-53.6°F)
Refrigerant(制冷剂)	R134a / R290	R134a / R290	R134a / R290
Climate(气候类型)	4	4	4
N.W.(净重)	33.5kg	33.5kg	42.5kg
G.W.(毛重)	36kg	36kg	45.5kg
Overall Dimension(产品尺寸)	425×380×1138(1278)mm	425×380×1238(1378)mm	425×380×1288(1428)mm
Package Dimension(包装尺寸)	470×435×1160mm	470×435×1260mm	470×435×1310mm
Approval(证书)	CE GS CB UKCA ETL NSF	CE GS CB UKCA ETL NSF	CE GS CB UKCA ETL NSF
20" Container(20" F')	126	126	126
40" Container (high)(40" F')	266	266	266

REFRIGERATED SHOWCASE

Changer Countertop Display

桌上型展示柜



Standard Features 标准配置

- Brilliant Internal LED lighting at 2 sides
- Adjustable glass shelves
- Shelf rotatable manually
- Digital temperature control and display
- Double tempered glass
- Ventilated cooling system
- Automatic Defrost
- Automatic closing door
- Stainless steel base

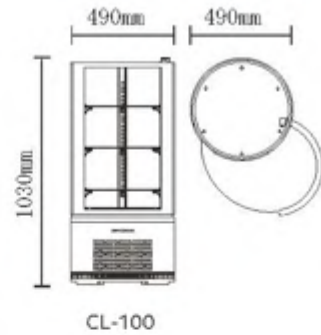

Model	CL-100
Capacity-Gross(容积)	100L/3.5c.f.
Temperature range(温度)	0-12°C (32-53.6°F)
Refrigerant(制冷剂)	R134a / R290
Climate(气候类型)	4
N.W.(净重)	52kg
G.W.(毛重)	55kg
Overall Dimension(产品尺寸)	490x490x1030mm
Package Dimension(包装尺寸)	540x540x1070mm
Approval(证书)	CE GS CB UKCA ETL NSF
20" Container(20" F')	80
40" Container (high)(40" F')	168



Standard Features 标准配置

- Digital temperature controller and display
- 8*1/6 GN pans
- Automatic defrost
- Direct cooling system
- Stainless steel
- Folding complete glass cover
- On/off switch
- Adjustable feet

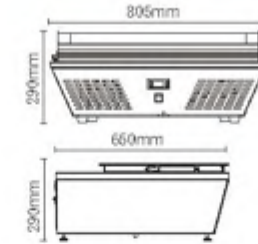

CW-67

Model	CW-67
Capacity-Gross(容积)	67L/2.3c.f.
Temperature range(温度)	2-12°C (35.6-53.6°F)
Refrigerant(制冷剂)	R134a / R290
Climate(气候类型)	4
N.W.(净重)	34.5kg
G.W.(毛重)	37kg
Overall Dimension(产品尺寸)	805x650x290mm
Package Dimension(包装尺寸)	870x715x325mm
Approval(证书)	CE GS CB UKCA ETL NSF
20" Container(20" F')	114
40" Container (high)(40" F')	273

REFRIGERATED SHOWCASE

Changer Standing Display 立式展示柜



Standard Features 标准配置

- Internal top LED lighting
- Digital temperature controller and display
- Adjustable PVC coated shelves
- Front curved tempered glass door
- 4 sides double tempered glass
- Base Feet
- Ventilated cooling system
- Automatic defrost

Options 选配

- Adjustable chrome plated shelves
- Brilliant Internal LED illumination on sides
- 4 Castors, 2 with brakes
- Top light box with LED

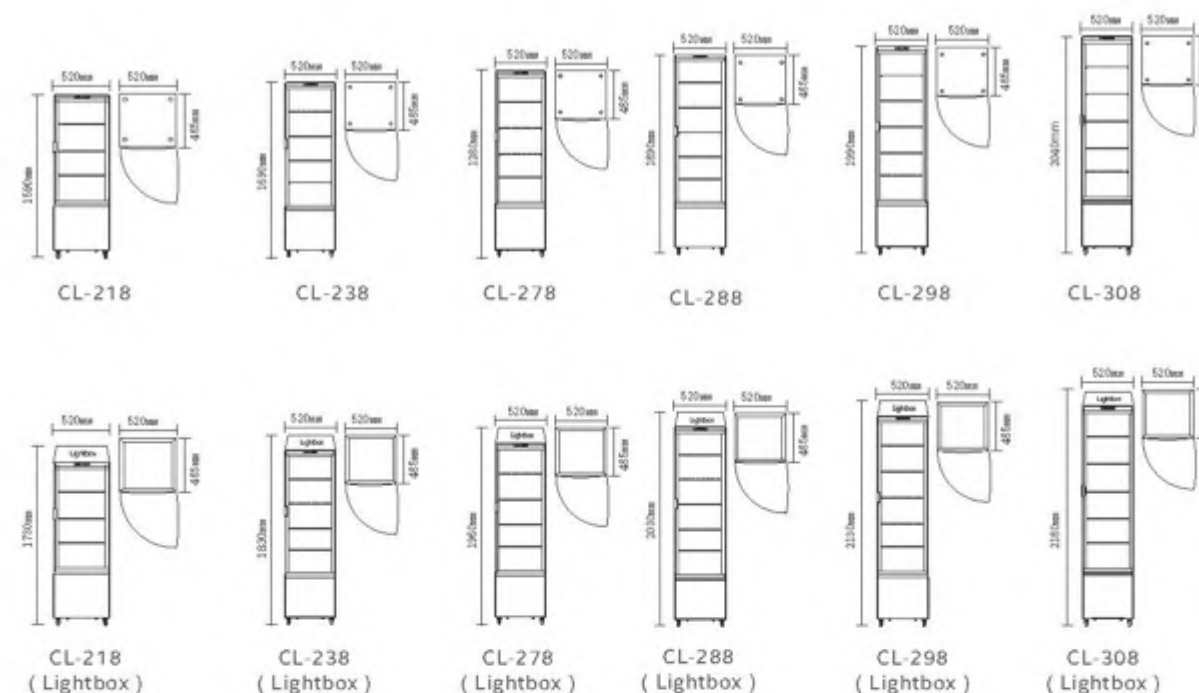

Model	CL-218	CL-238	CL-278
Capacity-Gross(容积)	215L/7.6c.f.	235L/8.3c.f.	260L/9.2c.f.
Temperature range(温度)	0-12°C (32-53.6°F)	0-12°C (32-53.6°F)	0-12°C (32-53.6°F)
Refrigerant(制冷剂)	R134a / R290	R134a / R290	R134a / R290
Climate(气候类型)	4	4	4
N.W.(净重)	73kg	76kg	85.5kg
G.W.(毛重)	77kg	81kg	91kg
Overall Dimension(产品尺寸)	520x485x1590(1730)mm	520x485x1690(1830)mm	520x485x1820(1960)mm
Package Dimension(包装尺寸)	580x540x1660mm	580x540x1760mm	580x540x1890mm
Approval(证书)	CE GS CB UKCA ETL NSF	CE GS CB UKCA ETL NSF	CE GS CB UKCA ETL NSF
20" Container(20" F')	40	40	40
40" Container (high)(40" F')	88	88	88

Model	CL-288	CL-298	CL-308
Capacity-Gross(容积)	270L/9.5c.f.	290L/10.2c.f.	300L/10.6c.f.
Temperature range(温度)	0-12°C (32-53.6°F)	0-12°C (32-53.6°F)	0-12°C (32-53.6°F)
Refrigerant(制冷剂)	R134a / R290	R134a / R290	R134a / R290
Climate(气候类型)	4	4	4
N.W.(净重)	89kg	91.5kg	92.5kg
G.W.(毛重)	94kg	97.5kg	98.5kg
Overall Dimension(产品尺寸)	520x485x1890(2030)mm	520x485x1990(2130)mm	520x485x2040(2180)mm
Package Dimension(包装尺寸)	580x540x1960mm	580x540x2060mm	580x540x2110mm
Approval(证书)	CE GS CB UKCA ETL NSF	CE GS CB UKCA ETL NSF	CE GS CB UKCA ETL NSF
20" Container(20" F')	40	40	40
40" Container (high)(40" F')	88	88	88

REFRIGERATED SHOWCASE

Changer Standing Display 立式展示柜



Standard Features 标准配置

- Brilliant LED on top and at 4 sides
- Digital temperature controller and display
- Adjustable chrome plated shelves
- Front flat glass door closing automatically
- 4 sides double tempered glass
- 4 castors, 2 with brakes
- On/ off switch
- Ventilated cooling system
- Automatic defrost
- Stainless steel base

Options 选配

- Black or white color

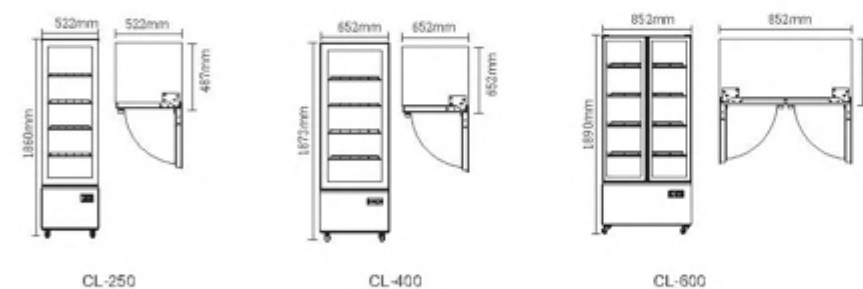

Model	CL-250	CL-400	CL-600
Capacity-Gross(容积)	250L/8.83c.f.	400L/14.1c.f.	600L/21.2c.f.
Temperature range(温度)	0-12°C (32-53.6°F)	0-12°C (32-53.6°F)	0-12°C (32-53.6°F)
Refrigerant(制冷剂)	R134a / R290	R134a / R290	R134a / R290
Climate(气候类型)	4	4	4
N.W.(净重)	104kg	132kg	155kg
G.W.(毛重)	114kg	147kg	175kg
Overall Dimension(产品尺寸)	522×487×1860mm	652×652×1873mm	852×652×1890mm
Package Dimension(包装尺寸)	585×550×2000mm	705×705×2020mm	915×715×2025mm
Approval(证书)	CE GS CB UKCA ETL NSF	CE GS CB UKCA ETL NSF	CE GS CB UKCA ETL NSF
20" Container(20" F')	40	24	18
40" Container (high)(40" F')	88	48	39

REFRIGERATED SHOWCASE

Changer Countertop Display 桌上型展示柜



Standard Features 标准配置

- Brilliant Internal LED illumination on 2 sides
- Digital temperature controller and display
- Adjustable PVC coated shelves
- 4 sides double tempered glass
- Front Curved glass
- Sliding doors at back
- Maintenance free condenser
- Ventilated cooling system
- Automatic defrost

Options 选配

- Adjustable chrome plated shelves

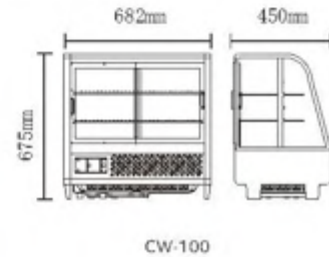

CW-100



Standard Features 标准配置

- Brilliant Internal LED at 2 sides
- Digital temperature controller and display
- 3 Adjustable chrome plated shelves
- 4 sides double tempered glass
- Hot air at front and 2 sides to remove condensation water
- Sliding doors at back
- Ventilated cooling system
- Automatic defrost



Low energy consumption
Simple construction and high security
Air duct outside the glass to remove condensation water

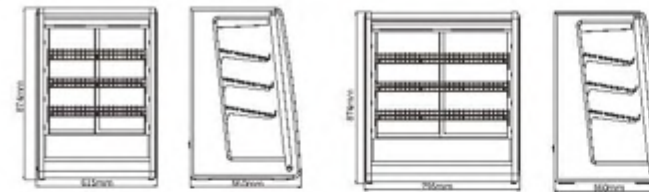

CW-146

CW-196

Model	CW-100
Capacity-Gross(容积)	100L/3.5c.f.
Temperature range(温度)	0-12°C (32-53.6°F)
Refrigerant(制冷剂)	R134a / R290
Climate(气候类型)	4
N.W.(净重)	39kg
G.W.(毛重)	43kg
Overall Dimension(产品尺寸)	682x450x675mm
Package Dimension(包装尺寸)	745x525x710mm
Approval(证书)	CE GS CB UKCA ETL NSF
20" Container(20" F')	90
40" Container (high)(40" F')	189

Model	CW-146	CW-196
Capacity-Gross(容积)	146L/5.2c.f.	196L/6.9 c.f.
Temperature range(温度)	2-12°C (35.6-53.6°F)	2-12°C (35.6-53.6°F)
Refrigerant(制冷剂)	R134a/R290	R134a/R290
Climate(气候类型)	4	4
N.W.(净重)	55kg	64kg
G.W.(毛重)	59kg	68kg
Overall Dimension(产品尺寸)	615x560x874mm	795x560x874mm
Package Dimension(包装尺寸)	665x630x950mm	845x630x950mm
Approval(证书)	CE GS CB UKCA ETL NSF	CE GS CB UKCA ETL NSF
20" Container(20" F')	54	48
40" Container (high)(40" F')	108	98

REFRIGERATED SHOWCASE

Changer Countertop Display

桌上型展示柜



Standard Features 标准配置

- Brilliant Internal LED illumination on top
- Digital temperature controller and display
- 2 Adjustable chrome plated shelves
- 4 sides double tempered glass
- Front Curved glass
- Sliding doors at back
- Maintenance free condenser
- Ventilated cooling system
- Automatic defrost



Options 选配

- Whole black or white color
- Front airduct to remove condensation water

Standard Features 标准配置

- Brilliant Internal LED illumination on top
- Digital temperature controller and display
- 2 Adjustable chrome plated shelves
- 4 sides double tempered glass
- Front Straight glass
- Sliding doors at back
- Maintenance free condenser
- Ventilated cooling system
- Automatic defrost

Options 选配

- Whole black or white color
- Front airduct to remove condensation water

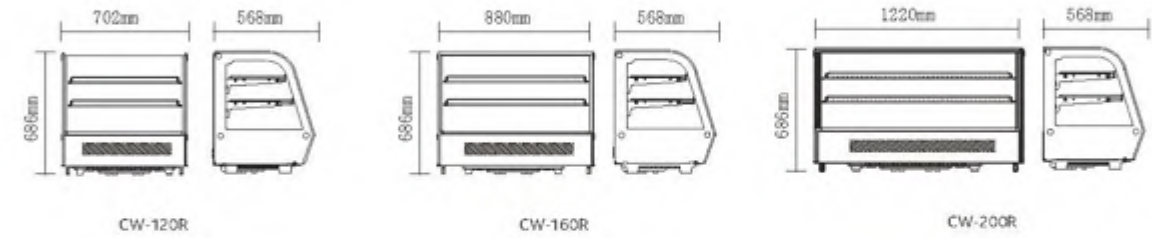

Model	CW-120R	CW-160R	CW-200R
Capacity-Gross(容积)	120L/4.2c.f.	160L/5.6c.f.	200L/7.0c.f.
Temperature range(温度)	0-12°C (32-53.6°F)	0-12°C (32-53.6°F)	0-12°C (32-53.6°F)
Refrigerant(制冷剂)	R134a / R290	R134a / R290	R134a / R290
Climate(气候类型)	4	4	4
N.W.(净重)	57kg	66kg	92kg
G.W.(毛重)	60kg	70kg	96kg
Overall Dimension(产品尺寸)	702x568x686mm	880x568x686mm	1220x568x686mm
Package Dimension(包装尺寸)	765x630x720mm	945x630x720mm	1285x630x720mm
Approval(证书)	CE GS CB UKCA ETL NSF	CE GS CB UKCA ETL NSF	CE GS CB UKCA ETL NSF
20" Container(20" F')	81	63	39
40" Container (high)(40" F')	162	126	84

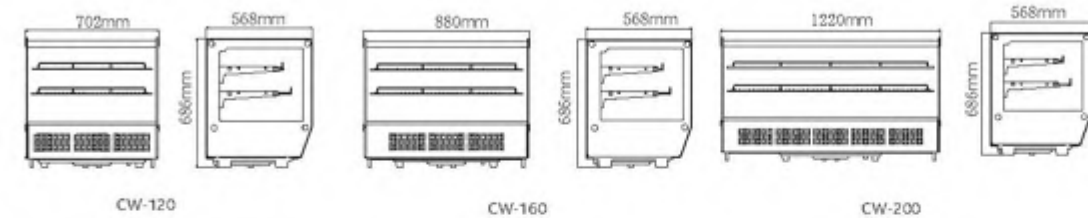

Model	CW-120	CW-160	CW-200
Capacity-Gross(容积)	120L/4.2c.f.	160L/5.6c.f.	200L/7.0c.f.
Temperature range(温度)	0-12°C (32-53.6°F)	0-12°C (32-53.6°F)	0-12°C (32-53.6°F)
Refrigerant(制冷剂)	R134a / R290	R134a / R290	R134a / R290
Climate(气候类型)	4	4	4
N.W.(净重)	57kg	66kg	92kg
G.W.(毛重)	60kg	70kg	96kg
Overall Dimension(产品尺寸)	702x568x686mm	880x568x686mm	1220x568x686mm
Package Dimension(包装尺寸)	765x630x720mm	945x630x720mm	1285x630x720mm
Approval(证书)	CE GS CB UKCA ETL NSF	CE GS CB UKCA ETL NSF	CE GS CB UKCA ETL NSF
20" Container(20" F')	81	63	39
40" Container (high)(40" F')	162	126	84

REFRIGERATED SHOWCASE

Changer Countertop Display

桌上型展示柜



2 side open



Standard Features 标准配置

- Brilliant internal LED illumination on top
- Digital temperature controller and display
- 2 Adjustable chrome plated shelves
- 4 sides double tempered glass
- Sliding doors at back and front
- Maintenance free condenser
- Ventilated cooling system
- Automatic defrost

Options 选配

Whole black or white color

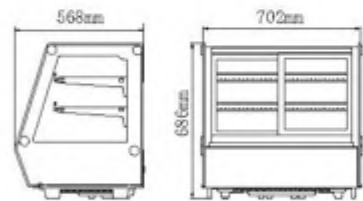

CW-120

Model	CW-120 2 side open
Capacity-Gross(容积)	120L/4.2c.f.
Temperature range(温度)	0-12°C (32-53.6°F)
Refrigerant(制冷剂)	R134a / R290
Climate(气候类型)	4
N.W.(净重)	57kg
G.W.(毛重)	60kg
Overall Dimension(产品尺寸)	702x568x686mm
Package Dimension(包装尺寸)	765x630x720mm
Approval(证书)	CE GS CB UKCA ETL NSF
20" Container(20" F')	81
40" Container (high)(40" F')	162

Standard Features 标准配置

- Brilliant internal LED illumination on top
- Digital temperature controller and display
- 2 Adjustable chrome plated shelves
- 4 sides double tempered glass
- Sliding doors at back
- Ventilated cooling system
- Automatic defrost

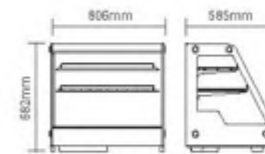
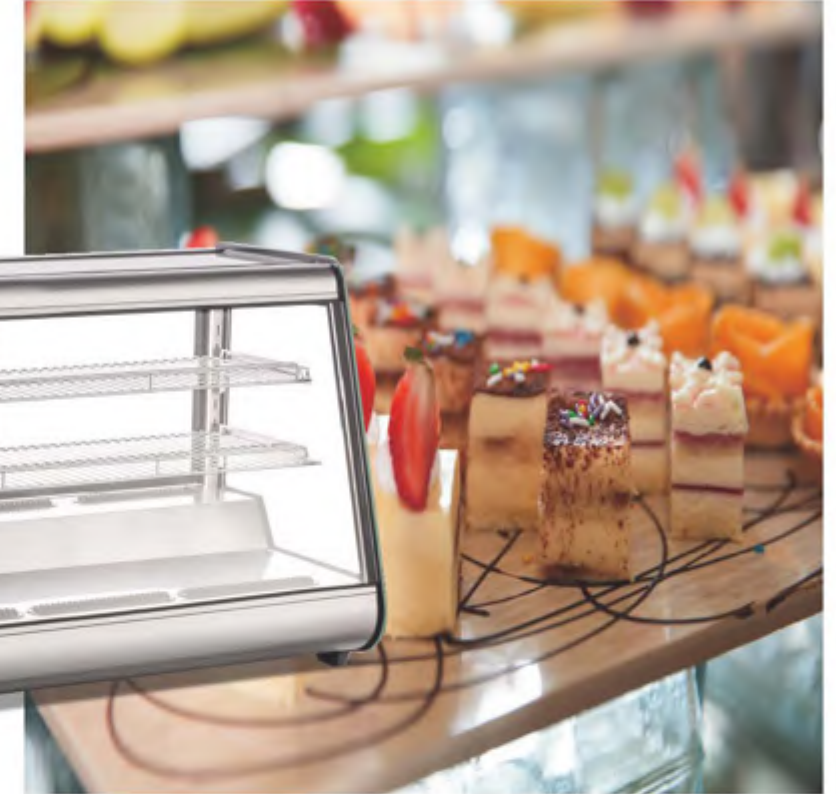

CW-120X

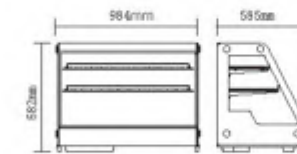

CW-160X

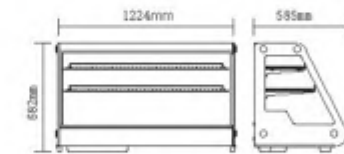

CW-200X

Model	CW-120X	CW-160X	CW-200X
Capacity-Gross(容积)	130L/4.5c.f.	160L/5.6c.f.	200L/7.0c.f.
Temperature range(温度)	0-12°C (32-53.6°F)	0-12°C (32-53.6°F)	0-12°C (32-53.6°F)
Refrigerant(制冷剂)	R134a / R290	R134a / R290	R134a / R290
Climate(气候类型)	4	4	4
N.W.(净重)	62kg	70kg	86kg
G.W.(毛重)	65kg	74kg	90kg
Overall Dimension(产品尺寸)	806x585x682mm	984x585x682mm	1224x585x682mm
Package Dimension(包装尺寸)	870x635x720mm	1050x635x720mm	1290x635x720mm
Approval(证书)	CE GS CB UKCA ETL NSF	CE GS CB UKCA ETL NSF	CE GS CB UKCA ETL NSF
20" Container(20" F')	81	63	39
40" Container (high)(40" F')	162	126	84

REFRIGERATED SHOWCASE

Changer Countertop Display

桌上型展示柜



Standard Features 标准配置

- Brilliant Internal LED on top
- Digital temperature controller and display
- 3 Adjustable chrome plated shelves
- 4 sides double tempered glass
- Front Curved glass
- Sliding doors at back
- Ventilated cooling system
- Automatic defrost



Options 选配

- Whole black or white color
- Front air duct to remove condensation water

Standard Features 标准配置

- Brilliant Internal LED on top
- Digital temperature controller and display
- 3 Adjustable chrome plated shelves
- 4 sides double tempered glass
- Front Straight glass
- Sliding doors at back
- Ventilated cooling system
- Automatic defrost

Options 选配

- Whole black or white color
- Front air duct to remove condensation water

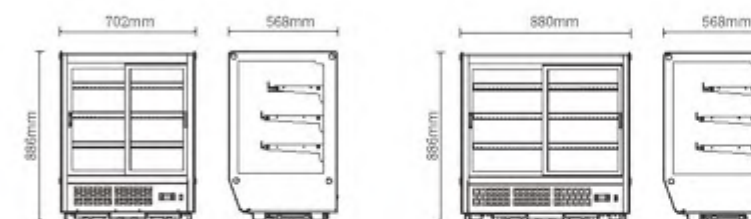

CW-145

CW-195

Model	CW-145	CW-195
Capacity-Gross(容积)	145L/5.1c.f.	195L/6.8c.f.
Temperature range(温度)	2-12°C (35.6-53.6°F)	2-12°C (35.6-53.6°F)
Refrigerant(制冷剂)	R134a / R290	R134a / R290
Climate(气候类型)	4	4
N.W.(净重)	70kg	79.5kg
G.W.(毛重)	74kg	85kg
Overall Dimension(产品尺寸)	702×568×886mm	880×568×886mm
Package Dimension(包装尺寸)	765×630×920mm	945×630×920mm
Approval(证书)	CE GS CB UKCA ETL NSF	CE GS CB UKCA ETL NSF
20" Container(20" F')	54	42
40" Container (high)(40" F')	108	84

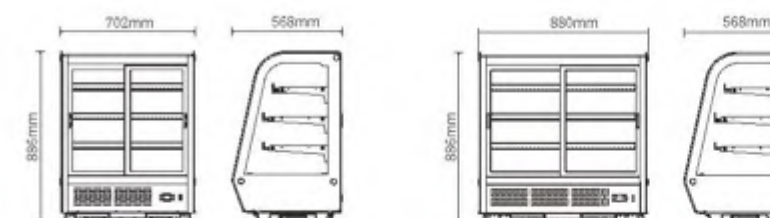

CW-145R

CW-195R

Model	CW-145R	CW-195R
Capacity-Gross(容积)	145L/5.1c.f.	195L/6.8c.f.
Temperature range(温度)	2-12°C (35.6-53.6°F)	2-12°C (35.6-53.6°F)
Refrigerant(制冷剂)	R134a / R290	R134a / R290
Climate(气候类型)	4	4
N.W.(净重)	70kg	79.5kg
G.W.(毛重)	74kg	85kg
Overall Dimension(产品尺寸)	702×568×886mm	880×568×886mm
Package Dimension(包装尺寸)	765×630×920mm	945×630×920mm
Approval(证书)	CE GS CB UKCA ETL NSF	CE GS CB UKCA ETL NSF
20" Container(20" F')	54	42
40" Container (high)(40" F')	108	84

REFRIGERATED SHOWCASE

Changer Countertop Display

桌上型展示柜



Standard Features 标准配置

- Drop-in design
- Brilliant Internal LED on top and under shelf
- Digital temperature controller and display
- 1 adjustable glass shelf
- 4 sides double tempered glass
- Sliding doors at back
- Ventilated cooling system
- Automatic defrost



Standard Features 标准配置

- Brilliant Internal LED on top and under each shelf
- Digital temperature controller and display
- 2 Adjustable glass shelf
- 4 sides double tempered glass
- Sliding doors at back and front
- Ventilated cooling system
- Automatic defrost

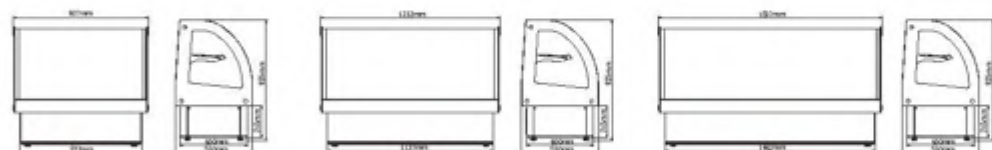

CW-135A CW-185A CW-235A

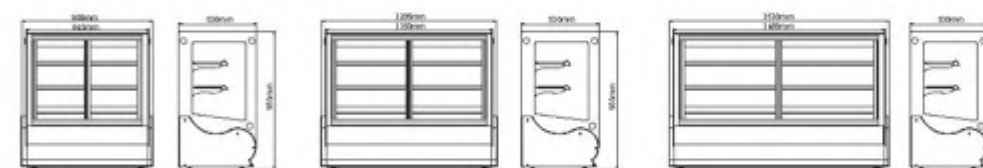

CW-185B CW-255B CW-325B

Model	CW-135A	CW-185A	CW-235A
Capacity-Gross(容积)	135L/4.8c.f.	185L/6.5c.f.	235L/8.3c.f.
Temperature range(温度)	0-12°C (32-53.6°F)	0-12°C (32-53.6°F)	0-12°C (32-53.6°F)
Refrigerant(制冷剂)	R134a / R290	R134a / R290	R134a / R290
Climate(气候类型)	4	4	4
N.W.(净重)	83.5kg	100kg	115kg
G.W.(毛重)	98kg	117kg	135kg
Overall Dimension(产品尺寸)	927x530x825mm	1232x530x825mm	1537x568x686mm
Package Dimension(包装尺寸)	995x605x990mm	1300x605x990mm	1605x630x720mm
Approval(证书)	CE GS CB UKCA ETL NSF	CE GS CB UKCA ETL NSF	CE GS CB UKCA ETL NSF
20" Container(20" F')	40	26	24
40" Container (high)(40" F')	84	56	52

Model	CW-185B	CW-255B	CW-325B
Capacity-Gross(容积)	185L/6.5c.f.	255L/9.0c.f.	325L/11.5c.f.
Temperature range(温度)	0-12°C (32-53.6°F)	0-12°C (32-53.6°F)	0-12°C (32-53.6°F)
Refrigerant(制冷剂)	R134a / R290	R134a / R290	R134a / R290
Climate(气候类型)	4	4	4
N.W.(净重)	103kg	116kg	139kg
G.W.(毛重)	116kg	133kg	160kg
Overall Dimension(产品尺寸)	900x530x950mm	1205x530x950mm	1510x530x950mm
Package Dimension(包装尺寸)	975x605x1120mm	1280x605x1120mm	1585x605x1120mm
Approval(证书)	CE GS CB UKCA ETL NSF	CE GS CB UKCA ETL NSF	CE GS CB UKCA ETL NSF
20" Container(20" F')	42	26	24
40" Container (high)(40" F')	86	56	52

REFRIGERATED SHOWCASE

Changer Countertop Display
桌上型展示柜



2 side open

Standard Features 标准配置

- Brilliant Internal LED on top and under shelf
- Digital temperature controller and display
- 1 adjustable glass shelf
- 4 sides double tempered glass
- Sliding doors at back
- Ventilated cooling system
- Automatic defrost

Options 选配

- Sliding doors at back and front

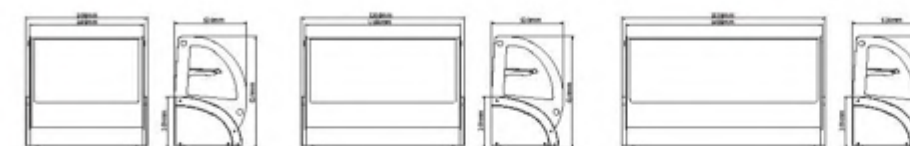

CW-125C

CW-175C

CW-225C

Model	CW-125C	CW-175C	CW-225C
Capacity-Gross(容积)	125L/4.4c.f.	175L/6.2c.f.	225L/7.9c.f.
Temperature range(温度)	0-12°C (32-53.6°F)	0-12°C (32-53.6°F)	0-12°C (32-53.6°F)
Refrigerant(制冷剂)	R134a / R290	R134a / R290	R134a / R290
Climate(气候类型)	4	4	4
N.W.(净重)	80.5kg	93.5kg	100kg
G.W.(毛重)	94kg	110kg	120kg
Overall Dimension(产品尺寸)	900x530x830mm	1250x530x830mm	1510x530x830mm
Package Dimension(包装尺寸)	975x605x990mm	1280x605x990mm	1585x605x990mm
Approval(证书)	CE GS CB UKCA ETL NSF	CE GS CB UKCA ETL NSF	CE GS CB UKCA ETL NSF
20" Container(20" F')	42	26	24
40" Container (high)(40" F')	86	56	52

REFRIGERATED SHOWCASE

Changer Cake Display

蛋糕柜



Standard Features 标准配置

- Brilliant Internal LED on top and under each shelf
- Digital temperature controller and display
- 3 Adjustable glass shelves
- 4 sides double tempered glass
- 4 Casters, 2 with brakes
- Ventilated cooling system
- Automatic defrost

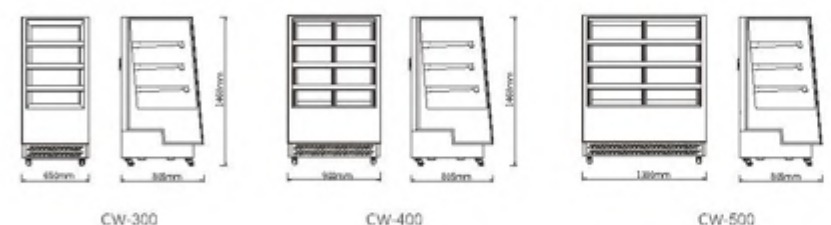

Model	CW-300	CW-400	CW-500
Capacity-Gross(容积)	350L/12.4c.f.	500L/17.7c.f.	650L/23.0c.f.
Temperature range(温度)	2-8°C (35.6-46.4°F)	2-8°C (35.6-46.4°F)	2-8°C (35.6-46.4°F)
Refrigerant(制冷剂)	R290	R290	R290
Climate(气候类型)	4	4	4
N.W.(净重)	135kg	160kg	190kg
G.W.(毛重)	158kg	180kg	220kg
Overall Dimension(产品尺寸)	650×805×1460mm	900×805×1460mm	1300×805×1460mm
Package Dimension(包装尺寸)	750×894×1615mm	1000×894×1615mm	1400×894×1615mm
Approval(证书)	CE GS CB UKCA ETL NSF	CE GS CB UKCA ETL NSF	CE GS CB UKCA ETL NSF
20" Container(20" F')	18	12	10
40" Container (high)(40" F')	38	24	21

REFRIGERATED SHOWCASE

Changer Cake Display

蛋糕柜



Standard Features 标准配置

Brilliant Internal LED on top and under each shelf
2 adjustable glass shelves
Digital temperature control and display
Double tempered glass
4 Castors with 2 brakes
Ventilated cooling system
Automatic Defrost

Options 选配

Whole black or white color
Air ducts at 3 sides to remove condensation water



Model	CW-270R	CW-370R	CW-470R	CW-570R
Capacity-Gross(容积)	295L/10.4c.f.	400L/14.1c.f.	500L/17.6c.f.	600L/21.1c.f.
Temperature range(温度)	2-8°C (35.6-46.4°F)	2-8°C (35.6-46.4°F)	2-8°C (35.6-46.4°F)	2-8°C (35.6-46.4°F)
Refrigerant(制冷剂)	R290	R290	R290	R290
Climate(气候类型)	4	4	4	4
N.W.(净重)	135kg	155kg	182kg	235kg
G.W.(毛重)	154kg	188kg	230kg	256kg
Overall Dimension(产品尺寸)	918x678x1200mm	1218x678x1200mm	1518x678x1200mm	1818x678x1200mm
Package Dimension(包装尺寸)	1010x760x1300mm	1310x760x1300mm	1610x760x1300mm	1910x760x1300mm
Approval(证书)	CE GS CB UKCA ETL NSF	CE GS CB UKCA ETL NSF	CE GS CB UKCA ETL NSF	CE GS CB UKCA ETL NSF
20" Container(20" F')	17	12	11	9
40" Container (high)(40" F')	68	50	46	36

REFRIGERATED SHOWCASE

Changer Cake Display

蛋糕柜



Standard Features 标准配置

- Brilliant Internal LED on top and under each shelf
- 2 adjustable glass shelves
- Digital temperature control and display
- Double tempered glass
- 4 Castors with 2 brakes
- Ventilated cooling system
- Automatic Defrost

Options 选配

- Whole black or white color
- Air ducts at 3 sides to remove condensation water

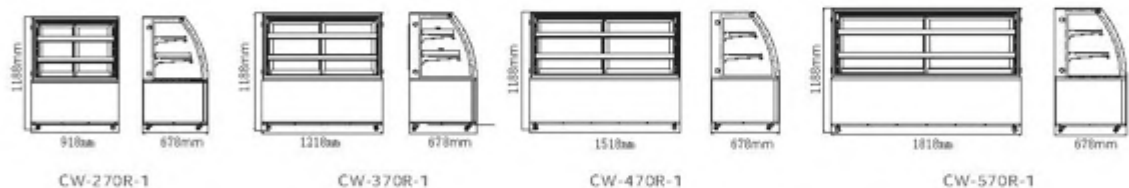

Model	CW-270R-1	CW-370R-1	CW-470R-1	CW-570R-1
Capacity-Gross(容积)	270L/9.5c.f.	370L/13.0c.f.	470L/16.5c.f.	570L/20.1c.f.
Temperature range(温度)	2-8°C (35.6-46.4°F)	2-8°C (35.6-46.4°F)	2-8°C (35.6-46.4°F)	2-8°C (35.6-46.4°F)
Refrigerant(制冷剂)	R290	R290	R290	R290
Climate(气候类型)	4	4	4	4
N.W.(净重)	130kg	160kg	185kg	215kg
G.W.(毛重)	160kg	195kg	230kg	260kg
Overall Dimension(产品尺寸)	918x678x1188mm	1218x678x1188mm	1518x678x1188mm	1818x678x1188mm
Package Dimension(包装尺寸)	1010x760x1300mm	1310x760x1300mm	1610x760x1300mm	1910x760x1300mm
Approval(证书)	CE GS CB UKCA ETL NSF	CE GS CB UKCA ETL NSF	CE GS CB UKCA ETL NSF	CE GS CB UKCA ETL NSF
20" Container(20" F')	17	12	11	9
40" Container (high)(40" F')	68	50	46	36



Standard Features 标准配置

- Brilliant Internal LED on top and under each shelf
- 3 adjustable glass shelves
- Digital temperature control and display
- Double tempered glass
- 4 Castors with 2 brakes
- Ventilated cooling system
- Automatic Defrost

Options 选配

- Whole black or white color
- Air ducts at 3 sides to remove condensation water



Model	CW-271R	CW-371R	CW-471R	CW-571R
Capacity-Gross(容积)	310L/10.9c.f.	420L/14.8c.f.	535L/18.8c.f.	650L/22.9c.f.
Temperature range(温度)	2-8°C (35.6-46.4°F)	2-8°C (35.6-46.4°F)	0-12°C (32-53.6°F)	0-12°C (32-53.6°F)
Refrigerant(制冷剂)	R290	R290	R290	R290
Climate(气候类型)	4	4	4	4
N.W.(净重)	146kg	177kg	210kg	235kg
G.W.(毛重)	175kg	212kg	246kg	280kg
Overall Dimension(产品尺寸)	918x678x1415mm	1218x678x1415mm	1518x678x1415mm	1818x678x1415mm
Package Dimension(包装尺寸)	1010x760x1520mm	1310x760x1520mm	1610x760x1520mm	1910x760x1520mm
Approval(证书)	CE GS CB UKCA ETL NSF	CE GS CB UKCA ETL NSF	CE GS CB UKCA ETL NSF	CE GS CB UKCA ETL NSF
20" Container(20" F')	17	12	10	9
40" Container (high)(40" F')	34	27	21	18

REFRIGERATED SHOWCASE

Changer Cake Display

蛋糕柜



Standard Features 标准配置

- Brilliant Internal LED on top and under each shelf
- 2 adjustable glass shelves
- Digital temperature control and display
- Double tempered glass
- 4 Castors with 2 brakes
- Ventilated cooling system
- Automatic Defrost

Options 选配

- Whole black or white color
- Air ducts at 3 sides to remove condensation water

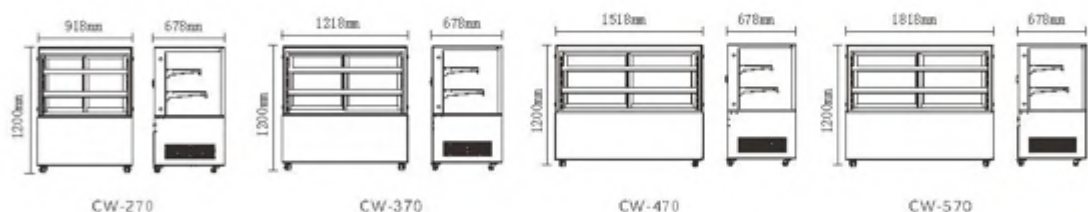

Model	CW-270	CW-370	CW-470	CW-570
Capacity-Gross(容积)	300L/10.6c.f.	410L/14.5c.f.	510L/18.0c.f.	610L/21.5c.f.
Temperature range(温度)	2-8°C (35.6-46.4°F)	2-8°C (35.6-46.4°F)	2-8°C (35.6-46.4°F)	2-8°C (35.6-46.4°F)
Refrigerant(制冷剂)	R290	R290	R290	R290
Climate(气候类型)	4	4	4	4
N.W.(净重)	135kg	155kg	182kg	225kg
G.W.(毛重)	154kg	188kg	230kg	246kg
Overall Dimension(产品尺寸)	918x678x1200mm	1218x678x1200mm	1518x678x1200mm	1818x678x1200mm
Package Dimension(包装尺寸)	1010x760x1300mm	1310x760x1300mm	1610x760x1300mm	1910x760x1300mm
Approval(证书)	CE GS CB UKCA ETL NSF	CE GS CB UKCA ETL NSF	CE GS CB UKCA ETL NSF	CE GS CB UKCA ETL NSF
20" Container(20" F')	17	12	11	9
40" Container (high)(40" F')	68	50	46	36



Standard Features 标准配置

- Brilliant Internal LED on top and under each shelf
- 3 adjustable glass shelves
- Digital temperature control and display
- Double tempered glass
- 4 Castors with 2 brakes
- Ventilated cooling system
- Automatic Defrost

Options 选配

- Whole black or white color
- Air ducts at 3 sides to remove condensation water



Model	CW-271	CW-371	CW-471	CW-571
Capacity-Gross(容积)	390L/13.7c.f.	530L/18.7c.f.	670L/23.6c.f.	810L/28.6c.f.
Temperature range(温度)	2-8°C (35.6-46.4°F)	2-8°C (35.6-46.4°F)	2-8°C (35.6-46.4°F)	2-8°C (35.6-46.4°F)
Refrigerant(制冷剂)	R290	R290	R290	R290
Climate(气候类型)	4	4	4	4
N.W.(净重)	162kg	195kg	229kg	245kg
G.W.(毛重)	190kg	229kg	252kg	290kg
Overall Dimension(产品尺寸)	918x678x1410mm	1218x678x1410mm	1518x678x1410mm	1818x678x1410mm
Package Dimension(包装尺寸)	1010x760x1520mm	1310x760x1520mm	1610x760x1520mm	1910x760x1520mm
Approval(证书)	CE GS CB UKCA ETL NSF	CE GS CB UKCA ETL NSF	CE GS CB UKCA ETL NSF	CE GS CB UKCA ETL NSF
20" Container(20" F')	17	12	11	9
40" Container (high)(40" F')	34	27	21	18

REFRIGERATED SHOWCASE

Changer Deli Showcase
熟食柜



Standard Features 标准配置

- Brilliant Internal LED on top and under each shelf
- Digital temperature controller and display
- 2 Adjustable glass shelves
- Double Duty Gravity Coil holds moisture and keeps it extra cold
- Big cool room at bottom for storage
- Double-tempered glass
- Sliding doors at back
- 4 casters, 2 with brakes
- 2 adjustable feet
- Condensation water evaporated automatically

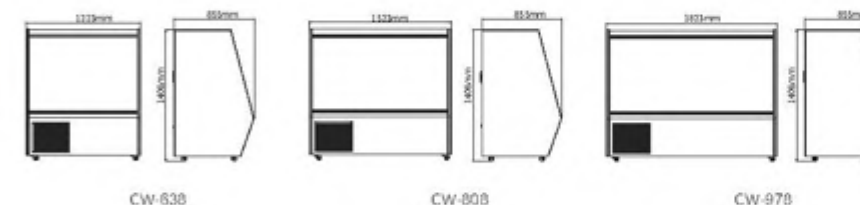

Model	CW-638-130	CW-808-185	CW-978-240
Capacity-Gross(容积)	638L/22.5c.f.	808L/28.5c.f.	978L/34.5c.f.
Temperature range(温度)	0-12°C (32-53.6°F)	0-12°C (32-53.6°F)	0-12°C (32-53.6°F)
Refrigerant(制冷剂)	R290	R290	R290
Climate(气候类型)	4	4	4
N.W.(净重)	151 kg	176kg	201kg
G.W.(毛重)	171 kg	200kg	231kg
Overall Dimension(产品尺寸)	1223×855×1406mm	1523×855×1406mm	1823×855×1406mm
Package Dimension(包装尺寸)	1285×915×1560mm	1585×915×1560mm	1885×915×1560mm
Approval(证书)	CE GS CB UKCA ETL NSF	CE GS CB UKCA ETL NSF	CE GS CB UKCA ETL NSF
20" Container(20" F')	10	7	6
40" Container (high)(40" F')	21	14	12

REFRIGERATED SHOWCASE

Changer Open Display
风幕柜



Standard Features 标准配置

- Brilliant LED on top and under shelf in top cabinet
- Light guild plate in bottom cabinet
- 2 complete cooling systems
- 2 Digital temperature controllers and displays
- 2 sets sliding doors at back
- Double-tempered glass
- 4 casters, 2 with brakes
- Condensation water evaporated automatically

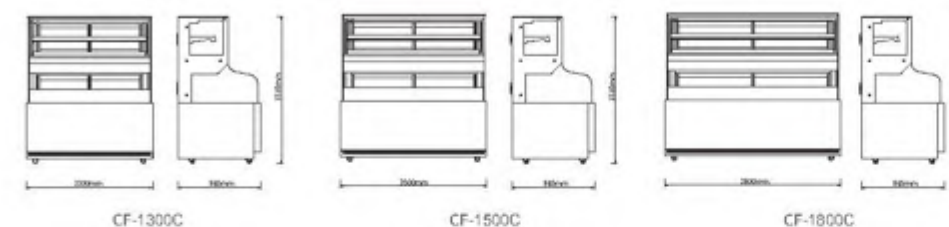

Model	CF-1300C	CF-1500C	CF-1800C
Capacity-Gross(容积)	335L/11.8c.f.	390L/13.7c.f.	470L/16.5c.f.
Temperature range(温度)	2-10°C (35.6-50°F)	2-10°C (35.6-50°F)	2-10°C (35.6-50°F)
Refrigerant(制冷剂)	R290	R290	R290
Climate(气候类型)	4	4	4
N.W.(净重)	223kg	256.5kg	308kg
G.W.(毛重)	226kg	293kg	353kg
Overall Dimension(产品尺寸)	1300x845x1510mm	1500x845x1510mm	1800x845x1510mm
Package Dimension(包装尺寸)	1370x915x1650mm	1570x915x1650mm	1870x915x1650mm
Approval(证书)	CE GS CB UKCA ETL NSF	CE GS CB UKCA ETL NSF	CE GS CB UKCA ETL NSF
20" Container(20" F')	10	7	6
40" Container (high)(40" F')	21	14	13

REFRIGERATED SHOWCASE

Changer Open Display

精品柜



Standard Features 标准配置

- Internal LED guide plate
- Digital temperature controller and display
- Tempered glass at 4 sides
- 4 Casters, 2 with brakes
- Ventilated cooling system
- Automatic defrost
- Water tray can be taken out

Options 选配

Stainless steel, black or whit color

Standard Features 标准配置

- Internal LED guide plate
- Digital temperature controller and display
- Tempered glass at 4 sides
- 4 Casters, 2 with brakes
- Ventilated cooling system
- Automatic defrost
- Water tray can be taken out

Options 选配

Stainless steel, black or whit color



CM-900 CM-1200 CM-1500

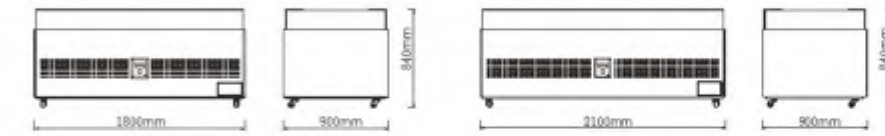

CM-1800 CM-2100

Model	CM-900	CM-1200	CM-1500	CM-1800	CM-2100
Capacity-Gross(容积)	120L/4.2c.f.	161L/5.6c.f.	202L/7.1c.f.	243L/8.5c.f.	284L/10.0c.f.
Temperature range(温度)	2-10°C (35.6-50°F)	2-10°C (35.6-50°F)	2-10°C (35.6-50°F)	2-10°C (35.6-50°F)	2-10°C (35.6-50°F)
Refrigerant(制冷剂)	R290	R290	R290	R290	R290
Climate(气候类型)	6	6	6	6	6
N.W.(净重)	100.5kg	117kg	134kg	150.5kg	167kg
G.W.(毛重)	119kg	150kg	178kg	199kg	240kg
Overall Dimension(产品尺寸)	900x900x840mm	1200x900x840mm	1500x900x840mm	1800x900x840mm	2100x900x840mm
Package Dimension(包装尺寸)	970x970x995mm	1270x970x995mm	1570x970x995mm	1870x970x995mm	2170x970x995mm
Approval(证书)	ETL NSF CE GS CB UKCA				
20" Container(20" F')	24	20	14	12	12
40" Container (high)(40" F')	48	42	30	24	24

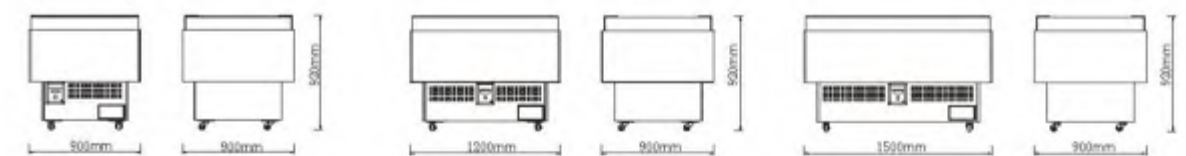

CM-900A CM-1200A CM-1500A

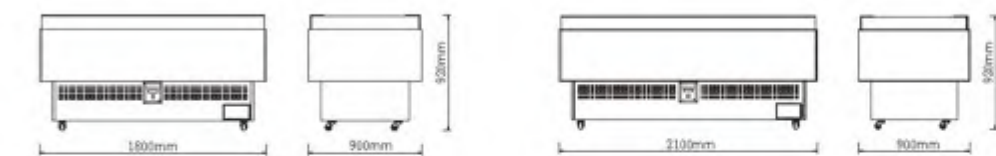

CM-1800A CM-2100A

Model	CM-900A	CM-1200A	CM-1500A	CM-1800A	CM-2100A
Capacity-Gross(容积)	182L/6.4c.f.	249L/8.7c.f.	316L/11.1c.f.	383L/11.1c.f.	450L/15.8c.f.
Temperature range(温度)	2-10°C (35.6-50°F)	2-10°C (35.6-50°F)	2-10°C (35.6-50°F)	2-10°C (35.6-50°F)	2-10°C (35.6-50°F)
Refrigerant(制冷剂)	R290	R290	R290	R290	R290
Climate(气候类型)	6	6	6	6	6
N.W.(净重)	101.5kg	120kg	138.5kg	157kg	175.5kg
G.W.(毛重)	121kg	153kg	182kg	216kg	248kg
Overall Dimension(产品尺寸)	900x900x920mm	1200x900x920mm	1500x900x920mm	1800x900x920mm	2100x900x920mm
Package Dimension(包装尺寸)	970x970x1075mm	1270x970x1075mm	1570x970x1075mm	1870x970x1075mm	2170x970x1075mm
Approval(证书)	CE GS CB UKCA ETL NSF				
20" Container(20" F')	24	20	14	12	12
40" Container (high)(40" F')	48	42	30	24	24

REFRIGERATED SHOWCASE

Changer Open Display

风幕柜



Standard Features 标准配置

- Brilliant Internal LED on top
- Digital temperature controller and display
- Double-tempered glass at 2 sides
- Mirror SS304 Internal
- With front curtain
- With 2 stainless steel steps
- 4 Casters, 2 with brakes
- Ventilated cooling system
- Automatic defrost
- Condensation water evaporated automatically

Options 选配

Whole black or white color



Standard Features 标准配置

- Brilliant Internal LED on top and under shelf
- Digital temperature controller and display
- Double-tempered glass at 2 sides
- Mirror SS304 Internal
- With front curtain
- With one Stainless steel shelf and 2 steps
- 4 Casters, 2 with brakes
- Ventilated cooling system
- Automatic defrost
- Condensation water evaporated automatically

Options 选配

Whole black or white color



CF-900A CF-1200A CF-1500A CF-1800A

Model	CF-900A	CF-1200A	CF-1500A	CF-1800A
Capacity-Gross(容积)	215L/7.5c.f.	294L/10.3c.f.	373L/13.1c.f.	451L/15.9c.f.
Temperature range(温度)	2-10°C (35.6-50°F)	2-10°C (35.6-50°F)	2-10°C (35.6-50°F)	2-10°C (35.6-50°F)
Refrigerant(制冷剂)	R290	R290	R290	R290
Climate(气候类型)	6	6	6	6
N.W.(净重)	118kg	147.5kg	177.5kg	208kg
G.W.(毛重)	156kg	185.5kg	215.5kg	246kg
Overall Dimension(产品尺寸)	900x845x1170mm	1200x845x1170mm	1500x845x1170mm	1800x845x1170
Package Dimension(包装尺寸)	976x921x1315mm	1276x921x1315mm	1576x921x1315mm	1876x921x1315
Approval(证书)	CE GS CB UKCA ETL NSF	CE GS CB UKCA ETL NSF	CE GS CB UKCA ETL NSF	CE GS CB UKCA ETL NSF
20" Container(20" F')	12	10	7	6
40" Container (high)(40" F')	52	44	30	26



CF-900B CF-1200B CF-1500B CF-1800B

Model	CF-900B	CF-1200B	CF-1500B	CF-1800B
Capacity-Gross(容积)	209L/7.3c.f.	286L/10.1c.f.	362L/12.7c.f.	439L/15.5c.f.
Temperature range(温度)	2-10°C (35.6-50°F)	2-10°C (35.6-50°F)	2-10°C (35.6-50°F)	2-10°C (35.6-50°F)
Refrigerant(制冷剂)	R290	R290	R290	R290
Climate(气候类型)	6	6	6	6
N.W.(净重)	112kg	142kg	172kg	202kg
G.W.(毛重)	150kg	180kg	210kg	240kg
Overall Dimension(产品尺寸)	900x845x1168mm	1200x845x1168mm	1500x845x1168	1800x845x1168
Package Dimension(包装尺寸)	976x921x1315mm	1276x921x1315mm	1576x921x1315	1876x921x1315
Approval(证书)	CE GS CB UKCA ETL NSF	CE GS CB UKCA ETL NSF	CE GS CB UKCA ETL NSF	CE GS CB UKCA ETL NSF
20" Container(20" F')	12	10	7	6
40" Container (high)(40" F')	52	44	30	26

REFRIGERATED SHOWCASE

Changer Open Display 风幕柜



Standard Features 标准配置

- Brilliant Internal LED on top and under each shelf
- Digital temperature controller and display
- 4 Adjustable frosty glass shelves
- Tempered glass at 2 sides
- Mirror SS304 Internal
- With front curtain
- 4 Casters, 2 with brakes
- Ventilated cooling system
- Automatic defrost
- Hot air at front and 2 sides to remove water on glass
- Condensation water evaporated automatically

Options 选配

Whole black or white color

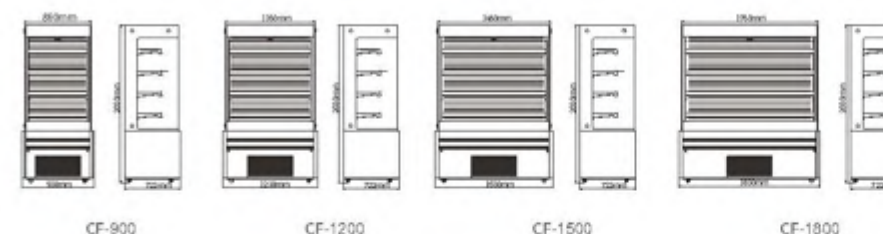

Model	CF-900	CF-1200	CF-1500	CF-1800
Capacity-Gross(容积)	500L/17.6c.f.	760L/26.8c.f.	960L/33.9c.f.	1160L/40.9c.f.
Temperature range(温度)	2-10°C (35.6-50°F)	2-10°C (35.6-50°F)	2-10°C (35.6-50°F)	2-10°C (35.6-50°F)
Refrigerant(制冷剂)	R290	R290	R290	R290
Climate(气候类型)	4	4	4	4
N.W.(净重)	189kg	220.5kg	252kg	293kg
G.W.(毛重)	201kg	238kg	272kg	316kg
Overall Dimension(产品尺寸)	930×722×2030mm	1230×722×2030mm	1530×722×2030mm	1830×722×2030mm
Package Dimension(包装尺寸)	1000×850×2230mm	1300×850×2230mm	1600×850×2230mm	1900×850×2230mm
Approval(证书)	CE GS CB UKCA ETL NSF	CE GS CB UKCA ETL NSF	CE GS CB UKCA ETL NSF	CE GS CB UKCA ETL NSF
20" Container(20" F')	13	11	7	6
40" Container (high)(40" F')	26	22	14	13

REFRIGERATED SHOWCASE

Changer Open Display 风幕柜

Standard Features 标准配置

- Brilliant Internal LED on top and under each shelf
- Digital temperature controller and display
- Adjustable frosty glass shelves
- Tempered glass at 2 sides
- Mirror SS304 Internal
- With front curtain
- 4 Casters, 2 with brakes
- Ventilated cooling system
- Automatic defrost
- Condensation water evaporated automatically

Options 选配

Whole black or white color

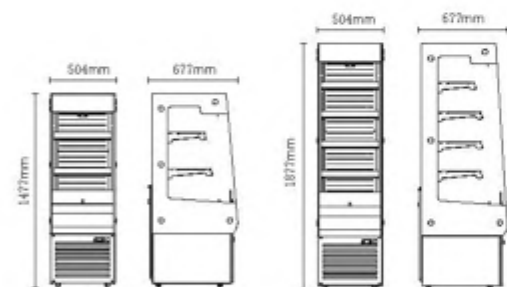

CF-180A

CF-220A



Standard Features 标准配置

- Brilliant Internal LED Lighting on top and under each shelf
- Digital temperature controller and display
- Adjustable stainless steel shelves
- 4 Castors with 2 brakes
- 2 Sides tempered glass
- With curtain
- Ventilated cooling system
- Automatic defrost
- Stainless steel
- Condenser at back side, free maintenance
- Condensation water evaporated automatically

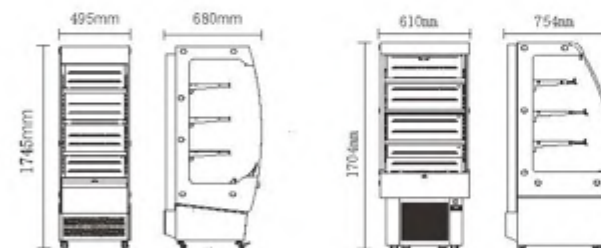

CF-220

CF-250



Model	CF-180A	CF-220A
Capacity-Gross(容积)	180L/6.4c.f.	220L/7.7c.f.
Temperature range(温度)	2-8°C (35.6-46.4°F)	2-8°C (35.6-46.4°F)
Refrigerant(制冷剂)	R290	R290
Climate(气候类型)	6	6
N.W.(净重)	107kg	128kg
G.W.(毛重)	122kg	146kg
Overall Dimension(产品尺寸)	495x680x1450mm	495x680x1745mm
Package Dimension(包装尺寸)	557x715x1625mm	557x715x2025mm
Approval(证书)	CE GS CB UKCA ETL NSF	CE GS CB UKCA ETL NSF
20" Container(20" F')	32	32
40" Container (high)(40" F')	64	64

Model	CF-220	CF-250
Capacity-Gross(容积)	220L/7.7c.f.	250L/8.8c.f.
Temperature range(温度)	2-10°C (35.6-50°F)	2-10°C (35.6-50°F)
Refrigerant(制冷剂)	R290	R290
Climate(气候类型)	6	6
N.W.(净重)	95kg	100kg
G.W.(毛重)	112kg	125kg
Overall Dimension(产品尺寸)	495x680x1745mm	610x754x1704mm
Package Dimension(包装尺寸)	560x730x1928mm	680x825x1890mm
Approval(证书)	CE GS CB UKCA ETL NSF	CE GS CB UKCA ETL NSF
20" Container(20" F')	32	21
40" Container (high)(40" F')	64	44

REFRIGERATED SHOWCASE

Changer Open Display

风幕柜



Standard Features 标准配置

- Brilliant Internal LED Lighting on top and under each shelf
- Digital temperature controller and display
- Adjustable stainless steel shelves
- 4 Castors with 2 brakes
- 2 Sides tempered glass
- With curtain
- Ventilated cooling system
- Automatic defrost
- Filter mesh in front of the base
- Condensator at back side, free maintenance
- Condensation water evaporated automatically

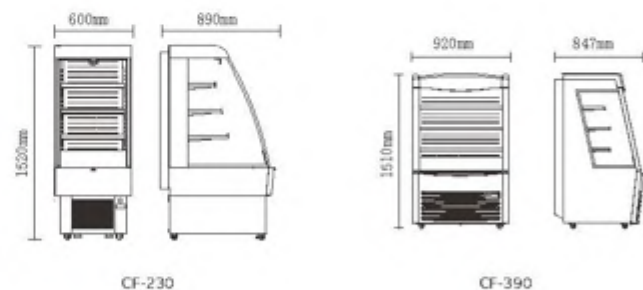

Model	CF-230	CF-380
Capacity-Gross(容积)	230L/8.1c.f.	380L/13.4c.f.
Temperature range(温度)	2-10°C (35.6-50°F)	2-10°C (35.6-50°F)
Refrigerant(制冷剂)	R290	R290
Climate(气候类型)	6	6
N.W.(净重)	85.5kg	107kg
G.W.(毛重)	108kg	129kg
Overall Dimension(产品尺寸)	600x890x1520mm	1000x890x1520mm
Package Dimension(包装尺寸)	675x930x1700mm	1075x930x1700mm
Approval(证书)	CE GS CB UKCA ETL NSF	CE GS CB UKCA ETL NSF
20" Container(20" F')	20	12
40" Container (high)(40" F')	41	24



Condensation water evaporated automatically



Standard Features 标准配置

- Brilliant Internal LED lighting at 2 front sides
- Digital temperature controller and display
- 4 Castors with 2 brakes
- Double tempered glass
- With curtain
- Ventilated cooling system
- Automatic defrost
- Adjustable shelves
- Condensation water evaporated automatically
- Condensator at back side, free maintenance

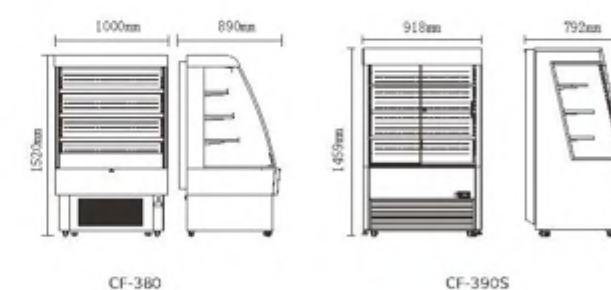

Model	CF-390	CF-390S
Capacity-Gross(容积)	320L/11.3c.f.	320L/11.3c.f.
Temperature range(温度)	2-10°C (35.6-50°F)	2-10°C (35.6-50°F)
Refrigerant(制冷剂)	R290	R290
Climate(气候类型)	4	4
N.W.(净重)	123kg	130.5kg
G.W.(毛重)	143kg	153kg
Overall Dimension(产品尺寸)	920x847x1510mm	918x792x1459mm
Package Dimension(包装尺寸)	990x920x1690mm	990x920x1690mm
Approval(证书)	CE GS CB UKCA ETL NSF	CE GS CB UKCA ETL NSF
20" Container(20" F')	12	12
40" Container (high)(40" F')	24	24

REFRIGERATED SHOWCASE

Changer Gelato Display 冰淇淋柜



Standard Features 标准配置

- Brilliant Internal LED on top
- Digital temperature controller and display
- Extra temperature display inside
- 5Liter Ice-cream pans can be ordered
- 4 sides double-tempered glass
- Sliding doors at black
- 4 Casters, 2 with brakes
- Ventilated cooling system
- Automatic defrost
- Hot air at front and 2 side to remove water on glass
- Condensation water evaporated automatically

Options 选配

Black or white color

Standard Features 标准配置

- Brilliant Internal LED on top
- Digital temperature controller and display
- Extra temperature display inside
- 5Liter Ice-cream pans can be ordered
- 4 sides double-tempered glass
- Sliding doors at black
- 4 Casters, 2 with brakes
- Ventilated cooling system
- Automatic defrost
- Hot air at front and 2 side to remove water on glass
- Condensation water evaporated automatically

Options 选配

Black or white color

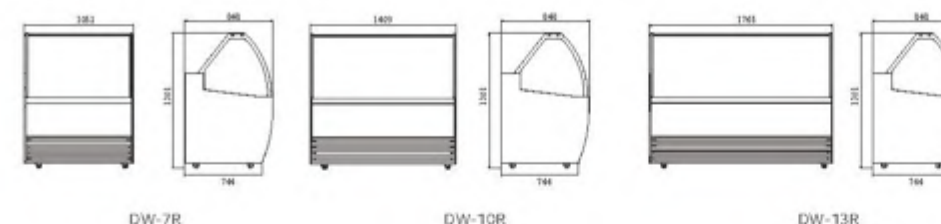

Model	DW-7R	DW-10R	DW-13R
Capacity-Gross(容积)	7*5L Ice-cream Pan.	10*5L Ice-cream Pan.	13*5L Ice-cream Pan.
Temperature range(温度)	-12 ~ -22°C(10.4~ -7.6°F)	-12 ~ -22°C(10.4~ -7.6°F)	-12 ~ -22°C(10.4~ -7.6°F)
Refrigerant(制冷剂)	R290	R290	R290
Climate(气候类型)	4	4	4
N.W.(净重)	139kg	169kg	197kg
G.W.(毛重)	192kg	229kg	264kg
Overall Dimension(产品尺寸)	1012x850x1300mm	1408x850x1300mm	1764x850x1300mm
Package Dimension(包装尺寸)	1130x960x1460mm	1486x960x1460mm	1840x960x1460mm
Approval(证书)	ETL NSF CE GS CB UKCA	ETL NSF CE GS CB UKCA	ETL NSF CE GS CB UKCA
20" Container(20" F')	12	7	6
40" Container (high)(40" F')	24	15	12

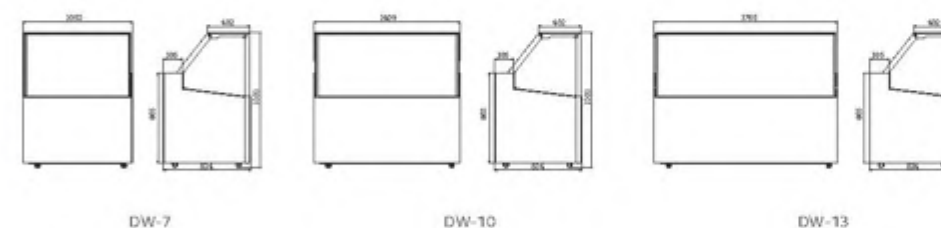

Model	DW-7	DW-10	DW-13
Capacity-Gross(容积)	7*5L Ice-cream Pan.	10*5L Ice-cream Pan.	13*5L Ice-cream Pan.
Temperature range(温度)	-12 ~ -22°C(10.4~ -7.6°F)	-12 ~ -22°C(10.4~ -7.6°F)	-12 ~ -22°C(10.4~ -7.6°F)
Refrigerant(制冷剂)	R290	R290	R290
Climate(气候类型)	4	4	4
N.W.(净重)	139kg	169kg	197kg
G.W.(毛重)	192kg	229kg	264kg
Overall Dimension(产品尺寸)	1012x850x1300mm	1408x850x1300mm	1764x850x1300mm
Package Dimension(包装尺寸)	1130x960x1460mm	1486x960x1460mm	1840x960x1460mm
Approval(证书)	CE GS CB UKCA ETL NSF	CE GS CB UKCA ETL NSF	CE GS CB UKCA ETL NSF
20" Container(20" F')	12	7	6
40" Container (high)(40" F')	24	15	12

REFRIGERATED SHOWCASE

Changer Gelato Display

冰淇淋柜

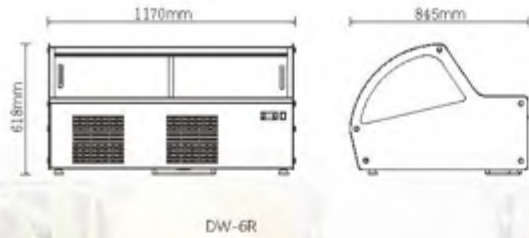

Standard Features 标准配置

- Brilliant Internal LED on top
- Digital temperature controller and display
- With 6pcs 1/3 GN Pans
- 4 sides double-tempered glass
- Sliding doors at black
- 4 Adjustable feet
- Ventilated cooling system
- Automatic defrost
- Hot air at front to remove water on glass
- Condensation water evaporated automatically

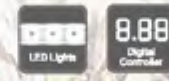

Model	DW-6R
Capacity-Gross(容积)	6*1/3 GN pans
Temperature range(温度)	-12 ~ -22°C(10.4~ -7.6°F)
Refrigerant(制冷剂)	R290
Climate(气候类型)	4
N.W.(净重)	93kg
G.W.(毛重)	115kg
Overall Dimension(产品尺寸)	1170x845x618mm
Package Dimension(包装尺寸)	1240x920x790mm
Approval(证书)	CE GS CB UKCA ETL NSF
20" Container(20" F')	20
40" Container (high)(40" F')	63

Standard Features 标准配置

- Digital temperature controller and display
- 8*1/6 GN pan or 4* 1/3 GN pan
- Automatic defrost
- Direct cooling system
- Stainless steel
- Folding complete glass cover
- On/off switch
- Adjustable feet

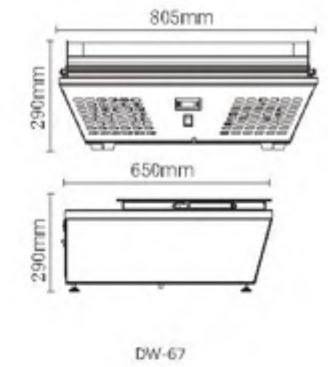

Model	DW-67
Capacity-Gross(容积)	67L/2.3c.f.
Temperature range(温度)	-12 ~ -22°C(10.4~ -7.6°F)
Refrigerant(制冷剂)	R134a / R290
Climate(气候类型)	4
N.W.(净重)	34.5kg
G.W.(毛重)	37kg
Overall Dimension(产品尺寸)	805x650x290mm
Package Dimension(包装尺寸)	870x715x325mm
Approval(证书)	CE GS CB UKCA ETL NSF
20" Container(20" F')	114
40" Container (high)(40" F')	273

REFRIGERATED SHOWCASE

Changer Freezer

冷冻柜

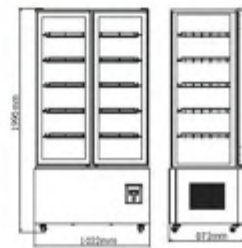

DL-600

Standard Features 标准配置

- 2pcs LED on top and 4pcs LED at sides
- Digital temperature controller and display
- 4 Adjustable chrome plated shelves
- 4 sides triple-tempered glass
- 2 Hinged doors at front
- 4 Casters, 2 with brakes
- Ventilated cooling system
- Automatic defrost
- Hot air at 4 sides to remove water on glass
- Condensation water evaporated automatically



Model	DL-600
Capacity-Gross(容积)	650L/23c.f.
Temperature range(温度)	-12 ~ -22°C(10.4~ -7.6°F)
Refrigerant(制冷剂)	R290
Climate(气候类型)	4
N.W.(净重)	241kg
G.W.(毛重)	265kg
Overall Dimension(产品尺寸)	1000x652x1890mm
Package Dimension(包装尺寸)	1060x715x2025mm
Approval(证书)	CE GS CB UKCA ETL NSF
20" Container(20" F')	16
40" Container (high)(40" F')	33



Standard Features 标准配置

- Internal LED on top
- Digital temperature controller and display
- Adjustable PVC shelves
- Triple-tempered glass door with automatic close
- Ventilated cooling system
- Automatic defrost
- With lock

Options 选配

- Black or white color
- Light box on top
- Heating element on door glass and frame

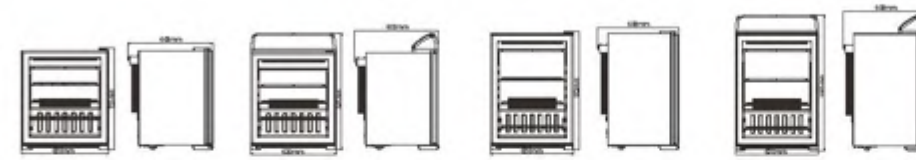

DL-99

DL-99(light)

DL-119

DL-119(light)

Model	DL-99	DL-119
Capacity-Gross(容积)	84L/2.9 c.f.	114L/4.0c.f.
Temperature range(温度)	-12 ~ -22°C(10.4~ -7.6°F)	-12 ~ -22°C(10.4~ -7.6°F)
Refrigerant(制冷剂)	R290	R290
Climate(气候类型)	4	4
N.W.(净重)	49kg	54.5kg
G.W.(毛重)	52kg	58kg
Overall Dimension(产品尺寸)	620x616x723(845)mm	620x616x883(1005)mm
Package Dimension(包装尺寸)	675x635x760(890)mm	675x635x920(1050)mm
Approval(证书)	CE GS CB UKCA ETL NSF	CE GS CB UKCA ETL NSF
20" Container(20" F')	81/54	54/54
40" Container (high)(40" F')	162/162	108/108

REFRIGERATED SHOWCASE

Changer Sushi Display 寿司柜



Standard Features 标准配置

- Brilliant Internal LED illumination on top
- Digital temperature controller and display
- Front Curved tempered glass
- Sliding doors at back
- Direct cooling system
- Automatic defrost
- Top evaporator with basin to collect condensation
- GN pan can be ordered

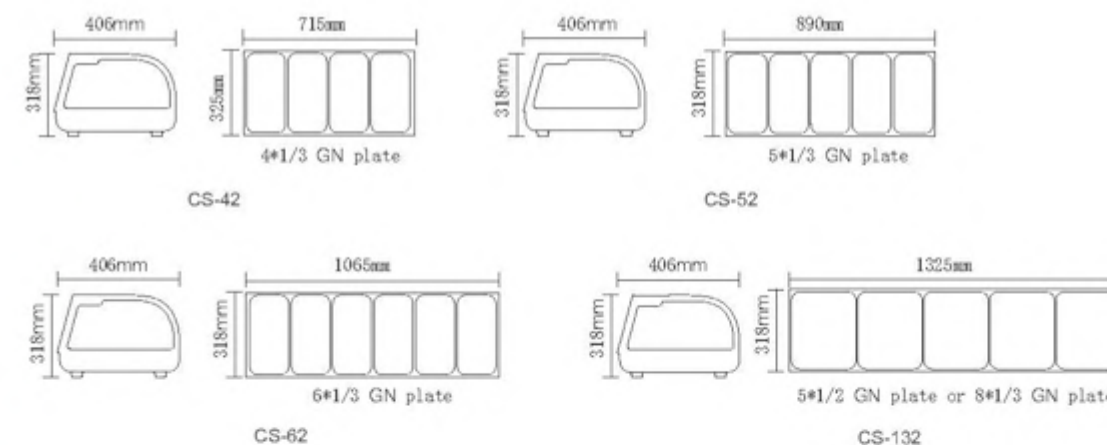

Model	CS-42	CS-52	CS-62	CS-132
Capacity-Gross(容积)	4*1/3 GN plate.	5*1/3 GN plate	6*1/3 GN plate	5*1/2 GN plate
Temperature range(温度)	0-12°C (32-53.6°F)	0-12°C (32-53.6°F)	0-12°C (32-53.6°F)	0-12°C (32-53.6°F)
Refrigerant(制冷剂)	R134a/R290	R134a/R290	R134a/R290	R134a/R290
Climate(气候类型)	4	4	4	4
N.W.(净重)	34.5kg	38.5kg	41.5kg	45kg
G.W.(毛重)	37kg	41kg	44kg	49kg
Overall Dimension(产品尺寸)	1177x406x318mm	1352x406x318mm	1529x406x318mm	1800x406x318mm
Package Dimension(包装尺寸)	1237x480x375mm	1413x480x375mm	1589x480x375mm	1860x480x375mm
Approval(证书)	CE GS CB UKCA ETL NSF	CE GS CB UKCA ETL NSF	CE GS CB UKCA ETL NSF	CE GS CB UKCA ETL NSF
20" Container(20" F')	114	84	84	72
40" Container (high)(40" F')	287	224	203	168

REFRIGERATED SHOWCASE

Changer Cushi Display 寿司柜



Standard Features 标准配置

- Brilliant Internal LED illumination on top
- Side light box with LED
- Digital temperature controller and display
- Sliding doors at back
- Direct cooling system
- Automatic defrost
- Top evaporator with basin to collect condensation
- GN pan can be ordered
- Front glass can be opened

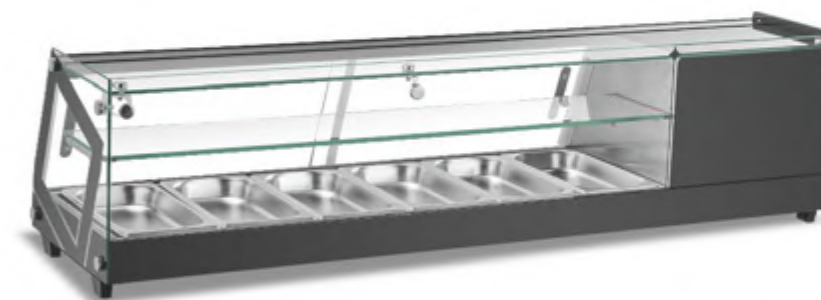

Standard Features 标准配置

- Brilliant Internal LED illumination on top
- Digital temperature controller and display
- Sliding doors at back
- Direct cooling system
- Automatic defrost
- GN pan can be ordered
- Fixed glass shelf

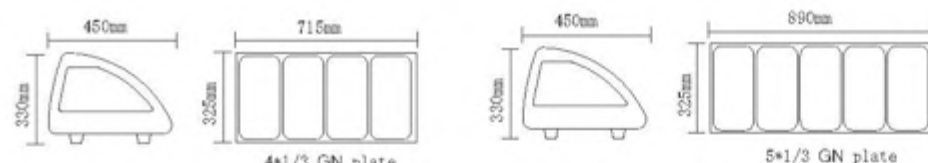

CS-43

CS-63

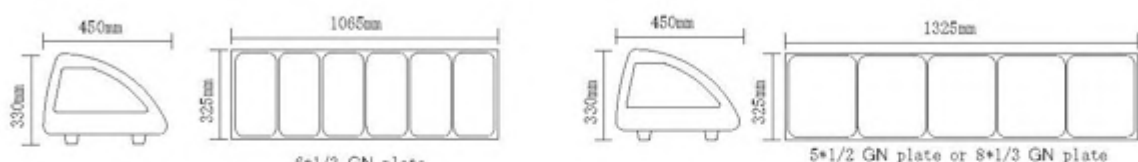

CS-83

CS-103

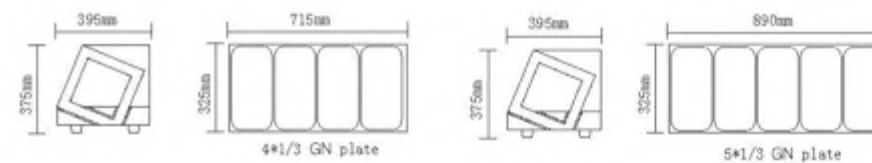

CS-44

CS-64



CS-84

CS-104

Model	CS-43	CS-63	CS-83	CS-103
Capacity-Gross(容积)	4*1/3 GN plate	5*1/3 GN plate	6*1/3 GN plate	5*1/2 GN plate
Temperature range(温度)	0-12°C (32-53.6°F)	0-12°C (32-53.6°F)	0-12°C (32-53.6°F)	0-12°C (32-53.6°F)
Refrigerant(制冷剂)	R134a/R290	R134a/R290	R134a/R290	R134a/R290
Climate(气候类型)	3	3	3	3
N.W.(净重)	33kg	36kg	39kg	44kg
G.W.(毛重)	36kg	39kg	43kg	48kg
Overall Dimension(产品尺寸)	1131x450x330mm	1307x450x330mm	1483x450x330mm	1754x450x330mm
Package Dimension(包装尺寸)	1177x500x370mm	1353x500x370mm	1529x500x370mm	1800x500x370mm
Approval(证书)	CE GS CB UKCA ETL NSF	CE GS CB UKCA ETL NSF	CE GS CB UKCA ETL NSF	CE GS CB UKCA ETL NSF
20" Container(20" F')	114	96	84	84
40" Container (high)(40" F')	240	198	174	168

Model	CS-44	CS-64	CS-84	CS-104
Capacity-Gross(容积)	4*1/3 GN plate	5*1/3 GN plate	6*1/3 GN plate	5*1/2 GN plate
Temperature range(温度)	0-12°C (32-53.6°F)	0-12°C (32-53.6°F)	0-12°C (32-53.6°F)	0-12°C (32-53.6°F)
Refrigerant(制冷剂)	R134a/R290	R134a/R290	R134a/R290	R134a/R290
Climate(气候类型)	3	3	3	3
N.W.(净重)	39kg	43kg	47kg	53kg
G.W.(毛重)	42kg	46kg	50kg	57kg
Overall Dimension(产品尺寸)	1131x395x375mm	1309x395x375mm	485x395x375mm	1756x395x375mm
Package Dimension(包装尺寸)	1187x460x430mm	1363x460x430mm	1539x460x430mm	1810x460x430mm
Approval(证书)	CE GS CB UKCA ETL NSF	CE GS CB UKCA ETL NSF	CE GS CB UKCA ETL NSF	CE GS CB UKCA ETL NSF
20" Container(20" F')	110	100	85	75
40" Container (high)(40" F')	282	246	222	186

REFRIGERATED SHOWCASE

Changer Salad Display

沙拉柜



Standard Features 标准配置

- Stainless steel body+glass top cover
- Digital controller and LED display
- GN pans can be ordered
- Direct cooling system
- Automatic defrost



Standard Features 标准配置

- Stainless steel body+SS top cover
- Digital controller and LED display
- GN pans can be ordered
- Direct cooling system
- Automatic defrost

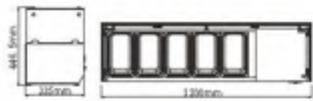

CS-1200

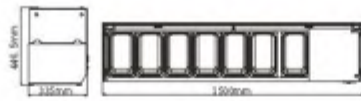

CS-1500

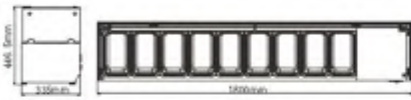

CS-1800

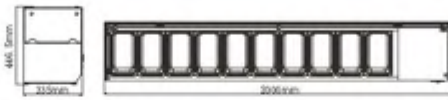

CS-2000

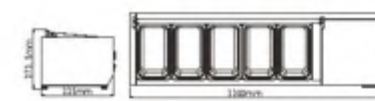

CS-1200-1



CS-1500-1



CS-1800-1



CS-2000-1

Model	CS-1200	CS-1500	CS-1800	CS-2000
Capacity-Gross(容积)	5*1/4 gn Pan	7*1/4 gn Pan	9*1/4 gn Pan	10*1/4 gn Pan
Temperature range(温度)	2-12°C(35.6~ 53.6°F)	2-12°C(35.6~ 53.6°F)	2-12°C(35.6~ 53.6°F)	2-12°C(35.6~ 53.6°F)
Refrigerant(制冷剂)	R134a/R290	R134a/R290	R134a/R290	R134a/R290
Climate(气候类型)	4	4	4	4
N.W.(净重)	39kg	45kg	51kg	55kg
G.W.(毛重)	42kg	48kg	54kg	58kg
Overall Dimension(产品尺寸)	1200x335x447mm	1500x335x447mm	1800x335x447mm	2000x335x447mm
Package Dimension(包装尺寸)	1275x390x310mm	1575x390x310m	1875x390x310mm	2075x390x310mm
Approval(证书)	CE GS CB UKCA ETL NSF	CE GS CB UKCA ETL NSF	CE GS CB UKCA ETL NSF	CE GS CB UKCA ETL NSF
20" Container(20" F')	182	147	126	112
40" Container (high)(40" F')	432	344	296	264

Model	CS-1200-1	CS-1500-1	CS-1800-1	CS-2000-1
Capacity-Gross(容积)	5*1/4 gn Pan	7*1/4 gn Pan	9*1/4 gn Pan	10*1/4 gn Pan
Temperature range(温度)	2-12°C(35.6~ 53.6°F)	2-12°C(35.6~ 53.6°F)	2-12°C(35.6~ 53.6°F)	2-12°C(35.6~ 53.6°F)
Refrigerant(制冷剂)	R134a/R290	R134a/R290	R134a/R290	R134a/R290
Climate(气候类型)	4	4	4	4
N.W.(净重)	28kg	32kg	35kg	38kg
G.W.(毛重)	31kg	35kg	38kg	41kg
Overall Dimension(产品尺寸)	1200x335x275mm	1500x335x275mm	1800x335x275mm	2000x335x275mm
Package Dimension(包装尺寸)	1275x390x310mm	1575x390x310mm	1875x390x310mm	2075x390x310mm
Approval(证书)	CE GS CB UKCA ETL NSF	CE GS CB UKCA ETL NSF	CE GS CB UKCA ETL NSF	CE GS CB UKCA ETL NSF
20" Container(20" F')	182	147	126	112
40" Container (high)(40" F')	432	344	296	264

REFRIGERATED SHOWCASE

Changer Chest Freezer 冷冻柜



Standard Features 标准配置

- Digital temperature controller and display
- Strong foaming body for best heat insulation
- High efficiency compressor for deep cooling
- SS304 liner
- 4 or 6 casters with brakes
- Low noise to operate quietly



Model	BD(W)-100D	BD(W)-150D	BD(W)-200D	BD(W)-300D	BD(W)-450D
Capacity-Gross(容积)	100L/3.5c.f.	150L/5.2c.f.	200L/7.0c.f.	300L/10.5c.f.	450L/15.8c.f.
Temperature range(温度)	≤ -60°C(≤ -76°F)	≤ -60°C(≤ -76°F)	≤ -60°C(≤ -76°F)	≤ -60°C(≤ -76°F)	≤ -60°C(≤ -76°F)
Climate(气候类型)	N	N	N	N	N
N.W.(净重)	47kg	53.8kg	60.5kg	75.5kg	98.5kg
G.W.(毛重)	50.5kg	57.4kg	64.5kg	80.5kg	104.5kg
Overall Dimension(产品尺寸)	720x600x845mm	940x600x845mm	1140x600x845mm	1190x743x845mm	1650x743x845mm
Package Dimension(包装尺寸)	770x577x883mm	987x577x883mm	1187x577x883mm	1237x725x883mm	1698x725x883mm
Approval(证书)	CB	CB	CB	CB	CB
40" Container (high)(40" F')	180	144	120	84	63



Standard Features 标准配置

- Mechanical temperature controller
- Adjustable thermostat
- Strong foaming body for good heat insulation
- High efficient compressor for fast cooling
- 4 casters, 2 with brakes
- Low noise to operate quietly
- Low energy consumption



Model	BD(W)-100G	BD(W)-150G	BD(W)-200G	BD(W)-270G
Capacity-Gross(容积)	100L/3.5c.f.	100L/5.2c.f.	200L/7.0c.f.	270L/9.5c.f.
Temperature range(温度)	≤ -18°C(≤ -0.4°F)	≤ -18°C(≤ -0.4°F)	≤ -18°C(≤ -0.4°F)	≤ -18°C(≤ -0.4°F)
Refrigerant(制冷剂)	R600a	R600a	R600a	R600a
Climate(气候类型)	N/ST/T	N/ST/T	N/ST/T	N/ST/T
N.W.(净重)	23kg	24.4kg	30.6kg	39kg
G.W.(毛重)	25.4kg	27.4kg	34.1kg	42kg
Overall Dimension(产品尺寸)	538x554x820mm	694x554x820mm	900x554x820mm	1155x554x820mm
Package Dimension(包装尺寸)	580x580x865mm	735x580x865mm	940x580x865mm	1195x580x865mm
Approval(证书)	CE,CB	CE,CB	CE,CB	CE,CB
40" Container (high)(40" F')	240	192	150	120

REFRIGERATED SHOWCASE

Changer Upright Showcase

立式展示柜



Standard Features 标准配置

- Internal brilliant LED at one side
- Mechanical temperature controller
- Adjustable thermostat
- Adjustable wire shelves
- Inner lighted canopy
- Door drying function
- Casters for easy moving
- With lock and key
- Ventilated cooling
- Manual defrost

Options 选配

- Top light box with LED for advertising
- 3-sides body stickers
- White or black color



Standard Features 标准配置

- Mechanical Temperature Control with Adjustable Thermostat
- Unique Design of Advertisement Bar
- Low Energy Consumption
- Convenience Wheels Design for Easy Moving
- Internal fan, can more evenly distribute the cold air in the cabinet
- Adjustable, flexible for storage
- Double tempered layer glass door



Model	SC-190	SC-240	SC-280
Capacity-Gross(容积)	190L/6.7c.f.	240L/8.4c.f.	280L/9.8c.f.
Temperature range(温度)	0-10°C (32-50°F)	0-10°C (32-50°F)	0-10°C (32-50°F)
Refrigerant(制冷剂)	N/ST/T	N/ST/T	N/ST/T
Climate(气候类型)	R134a/R600a	R134a/R600a	R134a/R600a
N.W.(净重)	44.1kg	49.1kg	55.7kg
G.W.(毛重)	48.1kg	53.6kg	60.7kg
Overall Dimension(产品尺寸)	556x530x1396mm	556x530x1676mm	556x530x1826mm
Package Dimension(包装尺寸)	580x585x1465mm	580x585x1745mm	580x585x1895mm
Approval(证书)	CB	CB	CB
40" Container (high)(40" F')	144	106	105

Model	SC-380C	SC-450C
Capacity-Gross(容积)	380L/13.4c.f.	450L/15.8c.f.
Temperature range(温度)	0-10°C (32-50°F)	0-10°C (32-50°F)
Refrigerant(制冷剂)	N/ST/T	N/ST/T
Climate(气候类型)	R134a/R600a	R134a/R600a
N.W.(净重)	62.5kg	71kg
G.W.(毛重)	68kg	77kg
Overall Dimension(产品尺寸)	595x650x1795mm	650x650x1795mm
Package Dimension(包装尺寸)	650x665x1830mm	705x665x1830mm
Approval(证书)	CE,CB	CE,CB
40" Container (high)(40" F')	73	73

REFRIGERATED SHOWCASE

Changer Upright Showcase

立式展示柜



Standard Features 标准配置

Internal brilliant LED at 2 sides
 Digital temperature controller and display
 Adjustable wire shelves
 Casters for easy moving
 Double-tempered glass door with auto-closing
 With lock and key
 Ventilated cooling
 Automatic defrost



Options 选配

3-sides body stickers
 White or black color

Model	SC-380B	SC-450B	SC-1000B
Capacity-Gross(容积)	380L/13.4c.f.	450L/15.8c.f.	1000L/35.3c.f.
Temperature range(温度)	0-10°C (32-50°F)	0-10°C (32-50°F)	0-10°C (32-50°F)
Refrigerant(制冷剂)	N/ST/T	N/ST/T	N/ST/T
Climate(气候类型)	R290	R290	R290
N.W.(净重)	76kg	77kg	135kg
G.W.(毛重)	80.5kg	82kg	143kg
Overall Dimension(产品尺寸)	595x580x1940mm	650x580x1940mm	1200x585x1980mm
Package Dimension(包装尺寸)	650x613x2020mm	705x613x2020mm	1255x630x2035mm
Approval(证书)	CB	CB	CB
40" Container (high)(40" F')	76	73	37



HOT SHOWCASE

Changer Countertop Display

桌上型展示柜



Standard Features 标准配置

Internal LED on top and 2 front sides
Adjustable temperature controller
Temperature display
Adjustable chrome plated shelves
Sliding doors at front and back

Options 选配

LED Temperature display

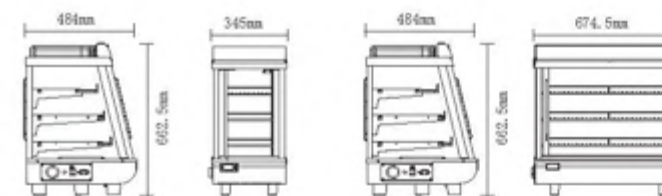

HW-76

HW-96

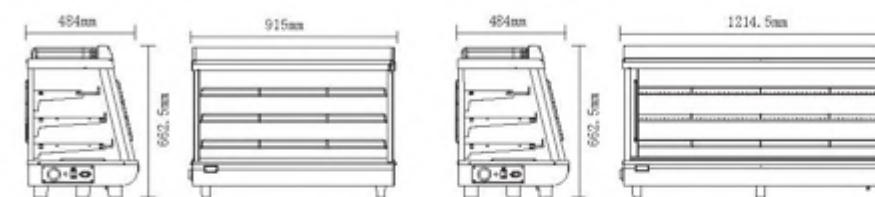

HW-136

HW-186

Model	HW-76	HW-96	HW-136	HW-186
Capacity-Gross(容积)	76L/2.6c.f.	96L/3.3c.f.	136L/4.8c.f.	186L/6.5c.f.
Temperature range(温度)	30-90°C (86-194°F)	30-90°C (86-194°F)	30-90°C (86-194°F)	30-90°C (86-194°F)
Rated Input Power(制热功率)	800W	1000W	1100W	1800W
N.W.(净重)	20kg	28.5kg	40kg	50kg
G.W.(毛重)	22kg	31kg	43kg	53kg
Overall Dimension(产品尺寸)	345×484×695mm	675×484×695mm	915×484×695mm	1215×484×695mm
Package Dimension(包装尺寸)	408×550×730mm	743×550×730mm	983×550×730mm	1283×550×730mm
Approval(证书)	CE GS CB UKCA	CE GS CB UKCA	CE GS CB UKCA	CE GS CB UKCA
20" Container(20" F')	174	93	66	51
40" Container (high)(40" F')	357	189	144	108

HOT SHOWCASE

Changer Countertop Display

展示柜



Model	HW-270	HW-370	HW-470	HW-570
Capacity-Gross(容积)	340L/12.0c.f.	465L/16.4c.f.	590L/20.8c.f.	715L/25.2c.f.
Temperature range(温度)	30-60 °C(86-140°F)	30-60 °C(86-140°F)	30-60 °C(86-140°F)	30-60 °C(86-140°F)
Rated Input Power(制热功率)	800W	800W	1100W	1100W
N.W.(净重)	99kg	120kg	140kg	160kg
G.W.(毛重)	129kg	155kg	180kg	185kg
Overall Dimension(产品尺寸)	900x685x1180mm	1200x685x1180mm	1500x685x1180mm	1800x685x1180mm
Package Dimension(包装尺寸)	970x755x1280mm	1270x755x1280mm	1570x755x1280mm	1870x755x1280mm
Approval(证书)	CE GS CB UKCA	CE GS CB UKCA	CE GS CB UKCA	CE GS CB UKCA
20" Container(20" F')	17	12	11	9
40" Container (high)(40" F')	68	50	46	36

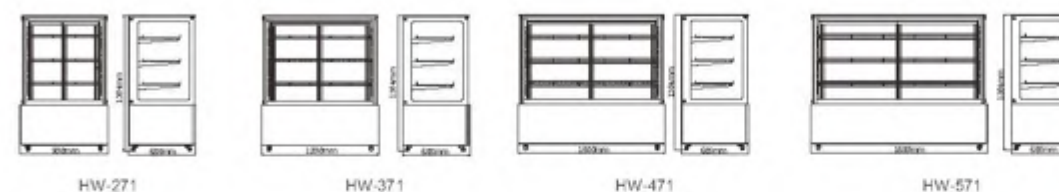

Model	HW-271	HW-371	HW-471	HW-571
Capacity-Gross(容积)	445L/15.7c.f.	605L/21.3c.f.	765L/27.0c.f.	925L/32.6c.f.
Temperature range(温度)	30-60 °C(86-140°F)	30-60 °C(86-140°F)	30-60 °C(86-140°F)	30-60 °C(86-140°F)
Rated Input Power(制热功率)	800W	800W	1100W	1100W
N.W.(净重)	109kg	131kg	153kg	175kg
G.W.(毛重)	148kg	176kg	204kg	232kg
Overall Dimension(产品尺寸)	900x685x1385mm	1200x685x1385mm	1500x685x1385mm	1800x685x1385mm
Package Dimension(包装尺寸)	970x755x1495mm	1270x755x1495mm	1570x755x1495mm	1870x755x1495mm
Approval(证书)	CE GS CB UKCA	CE GS CB UKCA	CE GS CB UKCA	CE GS CB UKCA
20" Container(20" F')	17	12	11	9
40" Container (high)(40" F')	34	27	21	18

Standard Features 标准配置

- Internal LED on top
- Digital temperature controller and Display
- 2 Adjustable chrome plated shelf
- Sliding doors at back
- 4 Casters, 2 with brakes

Options 选配

- Whole black or white color

Standard Features 标准配置

- Internal LED on top
- Digital temperature controller and Display
- 3 Adjustable chrome plated shelf
- Sliding doors at back
- 4 Casters, 2 with brakes

Options 选配

- Whole black or white color



HOT SHOWCASE

Changer Countertop Display

桌上型展示柜



Standard Features 标准配置

- Brilliant Internal LED illumination on top
- Adjustable temperature controller
- Temperature display
- Adjustable chrome plated shelves
- Front Curved tempered glass
- Sliding doors

Options 选配

- Black side glass

Standard Features 标准配置

- Brilliant Internal LED illumination on top
- Adjustable temperature controller
- Temperature display
- Adjustable chrome plated shelves
- Front Curved tempered glass
- Sliding doors

Options 选配

- Black side glass

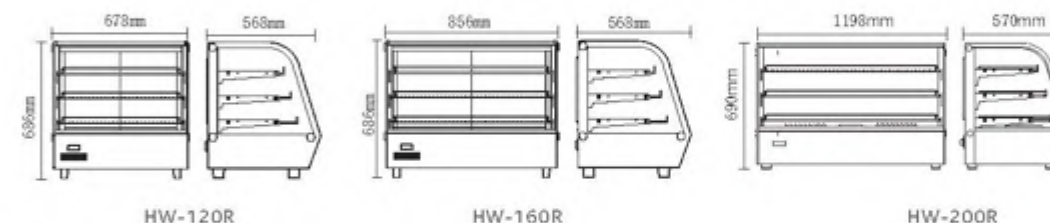

Model	HW-120R	HW-160R	HW-200R
Capacity-Gross(容积)	120L/4.2c.f.	160L/5.6c.f.	200L/7.0c.f.
Temperature range(温度)	30-90°C (86-194°F)	30-90°C (86-194°F)	30-90°C (86-194°F)
Rated Input Power(制热功率)	1100W	1500W	1500W
N.W.(净重)	35kg	43kg	55kg
G.W.(毛重)	38kg	46kg	59kg
Overall Dimension(产品尺寸)	678x568x686mm	856x568x686mm	1198x570x690mm
Package Dimension(包装尺寸)	745x630x720mm	928x630x720mm	1260x630x720mm
Approval(证书)	CE GS CB UKCA	CE GS CB UKCA	CE GS CB UKCA
20" Container(20" F')	81	63	39
40" Container (high)(40" F')	162	126	84

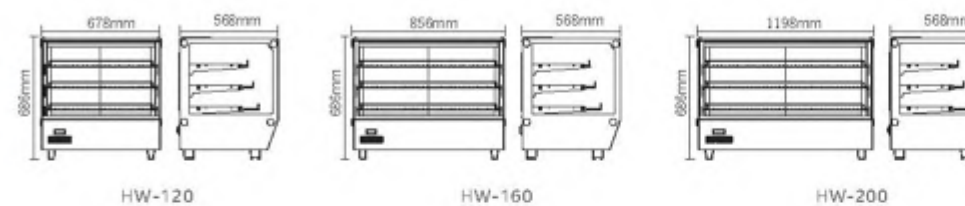

Model	HW-120	HW-160	HW-200
Capacity-Gross(容积)	120L/4.2c.f.	160L/5.6c.f.	200L/7.0c.f.
Temperature range(温度)	30-90°C (86-194°F)	30-90°C (86-194°F)	30-90°C (86-194°F)
Rated Input Power(制热功率)	1100W	1500W	1500W
N.W.(净重)	35kg	43kg	55kg
G.W.(毛重)	38kg	46kg	59kg
Overall Dimension(产品尺寸)	678x568x686mm	856x568x686mm	1198x570x690mm
Package Dimension(包装尺寸)	745x630x720mm	925x630x720mm	1260x630x720mm
Approval(证书)	CE GS CB UKCA	CE GS CB UKCA	CE GS CB UKCA
20" Container(20" F')	81	63	39
40" Container (high)(40" F')	162	126	84

HOT SHOWCASE

Changer Countertop Display

桌上型展示柜



Standard Features 标准配置

- Brilliant Internal LED illumination on top
- Adjustable temperature controller
- Digital temperature display
- Adjustable chrome plated shelves
- All tempered glass
- Sliding doors

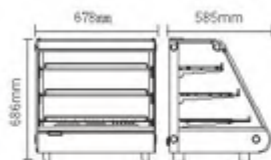

HW-120X

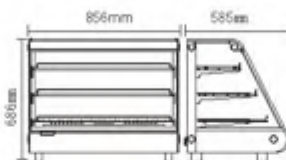

HW-160X

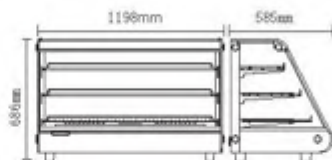

HW-200X

Model	HW-120X	HW-160X	HW-200X
Capacity-Gross(容积)	130L/4.5c.f.	160L/5.6c.f.	200L/7.0c.f.
Temperature range(温度)	30-90°C (86-194°F)	30-90°C (86-194°F)	30-90°C (86-194°F)
Rated Input Power(制热功率)	1100W	1500W	2000W
N.W.(净重)	34.5kg	42.5kg	54.5kg
G.W.(毛重)	37kg	45kg	58kg
Overall Dimension(产品尺寸)	678×585×686mm	856×585×686mm	1198×585×686mm
Package Dimension(包装尺寸)	735×635×720mm	913×635×720mm	1250×635×720mm
Approval(证书)	CE GS CB	CE GS CB	CE GS CB
20" Container(20" F')	81	63	39
40" Container (high)(40" F')	162	126	84



Standard Features 标准配置

- Brilliant Internal LED illumination on top
- Adjustable temperature controller
- Digital temperature display
- Adjustable chrome plated shelves
- All tempered glass
- Sliding doors

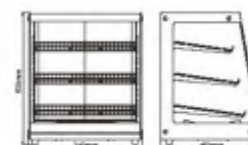

HW-205

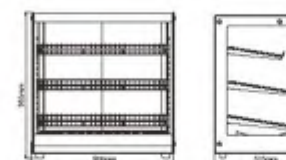

HW-318

Model	HW-205	HW-318
Capacity-Gross(容积)	205L/7.2c.f.	318L/11.2c.f.
Temperature range(温度)	30-80°C (86-176°F)	30-80°C (86-176°F)
Rated Input Power(制热功率)	1400W	1400W
N.W.(净重)	64.5kg	74.5kg
G.W.(毛重)	67kg	77.5kg
Overall Dimension(产品尺寸)	740×650×850mm	800×575×965mm
Package Dimension(包装尺寸)	790×715×890mm	860×635×1005mm
Approval(证书)	CE GS CB	CE GS CB
20" Container(20" F')	46	48
40" Container (high)(40" F')	138	98

HOT SHOWCASE

Changer Countertop Display

桌上型展示柜

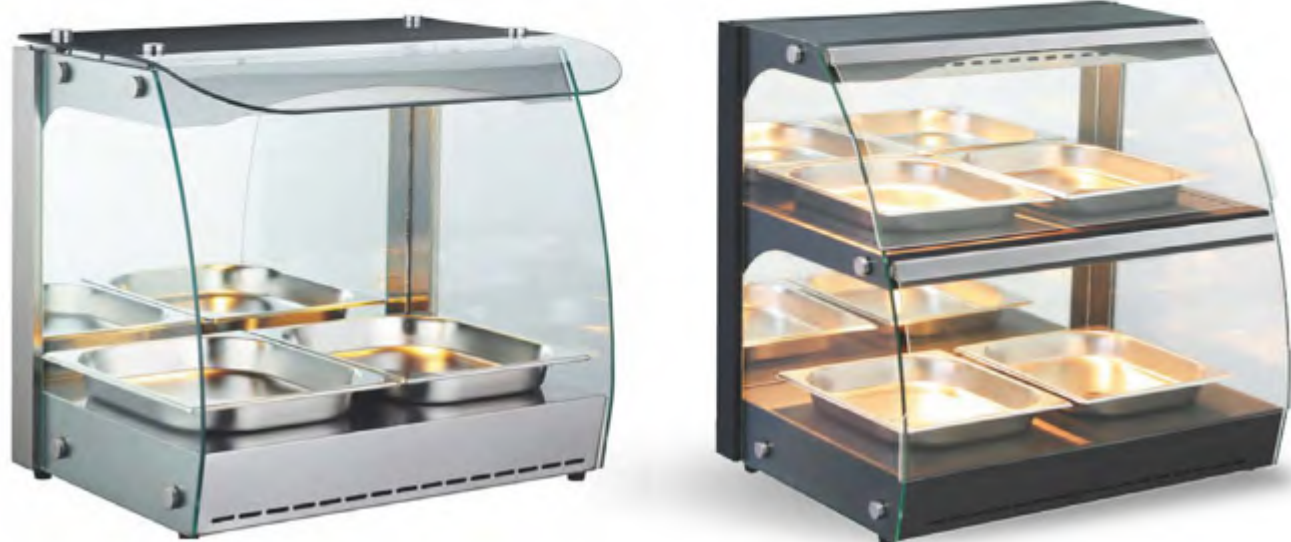

Standard Features 标准配置

- Brilliant Internal illumination on sides
- Adjustable temperature controller
- Non-adjustable shelf
- Fixed rubber feet
- Stainless steel
- Front Acrylic hinge door

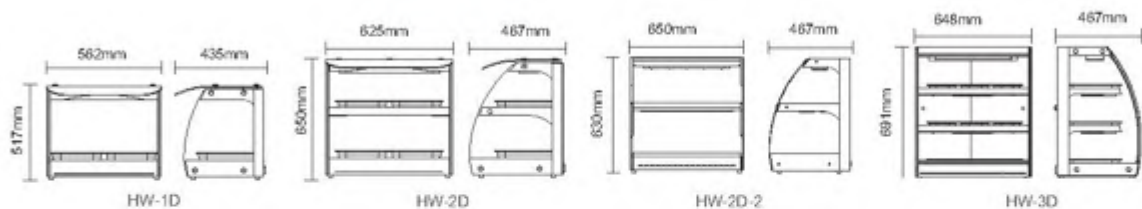

Model	HW-1D	HW-2D	HW-2D-2	HW-3D
Capacity-Gross(容积)	0.2m ²	0.48m ²	0.5m ²	145L(Capacity-Gross)
Temperature range(温度)	30-85°C (86-185 °F)	30-85°C (86-185 °F)	30-85°C (86-185 °F)	30-90°C (86-194 °F)
Rated Input Power(制热功率)	550W	560W	560W	1160W
N.W.(净重)	18.1kg(39.9lbs)	25.6kg(56.4lbs)	26.5kg(58.4lbs)	32kg(70.5lbs)
G.W.(毛重)	20.5kg(45.2lbs)	28kg(61.7lbs)	28.5kg(62.8lbs)	35kg(77.2lbs)
Overall Dimension(产品尺寸)	562×435×517mm	625×467×650mm	650×467×630mm	648×467×691mm
Package Dimension(包装尺寸)	625×505×600mm	690×535×700mm	715×535×680mm	719×537×755mm
Approval(证书)	CE GS CB	CE GS CB	CE GS CB	CE GS CB
20" Container(20" F')	160	108	102	102
40" Container (high)(40" F')	328	219	207	207



Standard Features 标准配置

- Black frosted outer body
- Tempered glass sides
- Independent heat & light controls for each shelf
- Adjustable thermostat
- Adjustable divider rods for easy organization of food product
- Fixed rubber feet

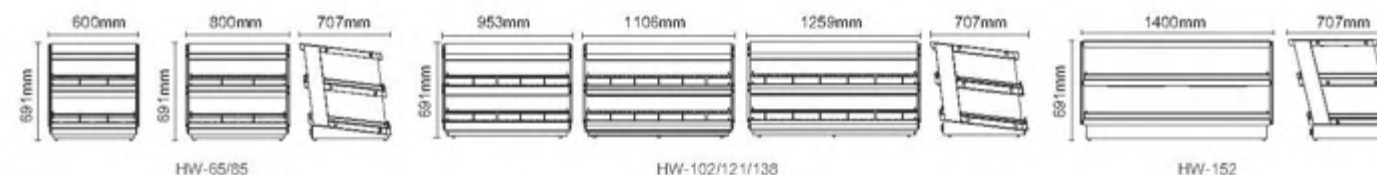

Model	HW-65	HW-85	HW-102
Capacity-Gross(容积)	0.65m ²	0.85m ²	1.02m ²
Temperature range(温度)	30-85°C (86-185°F)	30-85°C (86-185°F)	30-85°C (86-185°F)
Rated Input Power(制热功率)	1160W	1160W	1160W
N.W.(净重)	41kg	41kg	49kg(108.0lbs)
G.W.(毛重)	44kg	44kg	52kg(114.6lbs)
Overall Dimension(产品尺寸)	600×707×691mm	800×707×691mm	953×707×691mm
Package Dimension(包装尺寸)	666×767×736mm	866×767×736mm	1019×767×736mm
Approval(证书)	CE GS CB	CE GS CB	CE GS CB
20" Container(20" F')	72	57	51
40" Container (high)(40" F')	153	117	102

Model	HW-121	HW-138	HW-152
Capacity-Gross(容积)	1.21m ²	1.38m ²	1.52m ²
Temperature range(温度)	30-85°C (86-185°F)	30-85°C (86-185°F)	30-85°C (86-185°F)
Rated Input Power(制热功率)	1860W	1860W	2200W
N.W.(净重)	55kg(121.3lbs)	65kg(143.3lbs)	74kg(163.1lbs)
G.W.(毛重)	58kg(127.9lbs)	68kg(149.9lbs)	78kg(172.0lbs)
Overall Dimension(产品尺寸)	1106×707×691mm	1259×707×691mm	1400×707×691mm
Package Dimension(包装尺寸)	1172×767×736mm	1325×767×736mm	1486×860×705mm
Approval(证书)	CE GS CB	CE GS CB	CE GS CB
20" Container(20" F')	49	36	27
40" Container (high)(40" F')	90	75	60

HOT SHOWCASE

Changer Countertop Display

桌上型展示柜



Standard Features 标准配置

- Adjustable temperature controller
- Non-adjustable chrome plated shelves
- Stainless steel
- Hinge doors
- Wooden box

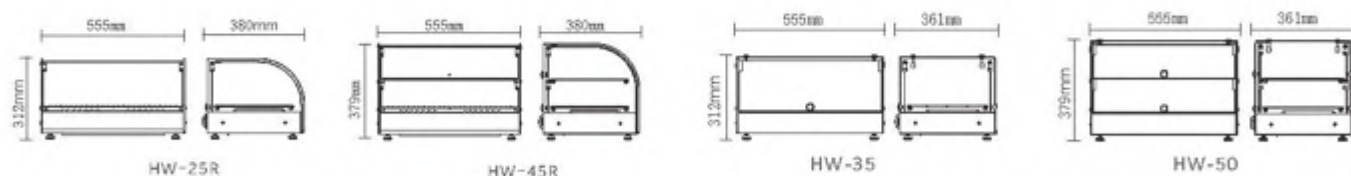

Model	HW-25R	HW-45R	HW-35	HW-50
Capacity-Gross(容积)	25L/0.8c.f.	45L/1.5c.f.	35L/1.2c.f.	50L/1.7c.f.
Temperature range(温度)	30-90°C (86-194°F)	30-90°C (86-194°F)	30-90°C (86-194°F)	30-90°C (86-194°F)
Rated Input Power(制热功率)	800W	800W	800W	800W
N.W.(净重)	12.5kg	15kg	12kg	14kg
G.W.(毛重)	14kg	17kg	14kg	16kg
Overall Dimension(产品尺寸)	555x380x312mm	555x380x379mm	555x361x312mm	555x361x379mm
Package Dimension(包装尺寸)	610x450x370mm	610x450x440mm	610x430x370mm	610x430x440mm
Approval(证书)	CE GS CB UKCA	CE GS CB UKCA	CE GS CB UKCA	CE GS CB UKCA
20" Container(20" F')	276	230	288	240
40" Container (high)(40" F')	665	570	679	582



Standard Features 标准配置

- Brilliant internal LED illumination on 4 sides
- Adjustable temperature controller
- Non-adjustable chrome plated shelves
- Stainless steel
- Hinge doors
- Wooden box

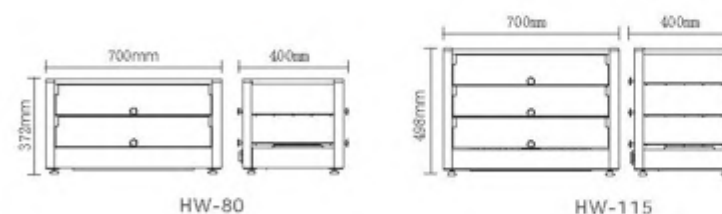

Model	HW-80	HW-115
Capacity-Gross(容积)	80L/2.8c.f.	115L/4.0c.f.
Temperature range(温度)	30-90°C (86-194°F)	30-90°C (86-194°F)
Rated Input Power(制热功率)	1000W	1250W
N.W.(净重)	16.5kg	20kg
G.W.(毛重)	19kg	22kg
Overall Dimension(产品尺寸)	700x400x372mm	700x400x498mm
Package Dimension(包装尺寸)	760x475x430mm	760x475x555mm
Approval(证书)	CE GS CB UKCA	CE GS CB UKCA
20" Container(20" F')	180	144
40" Container (high)(40" F')	432	288

HOT SHOWCASE

Changer Countertop Display

桌上型展示柜



Standard Features 标准配置

- Internal LED at 4 sides
- Digital temperature controller and Display
- Adjustable humidity and heat controls
- Hinged doors at back
- Self-rotated shelf
- Stainless steel

Options 选配

- Hinged doors at front and back

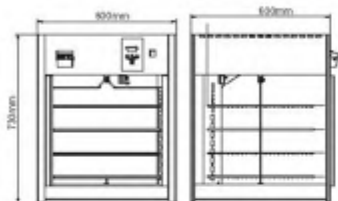

HW-158

Model	HW-158
Capacity-Gross(容积)	158L/5.6c.f.
Temperature range(温度)	30-90°C (86-194°F)
Rated Input Power(制热功率)	800W
N.W.(净重)	32kg
G.W.(毛重)	34kg
Overall Dimension(产品尺寸)	600×642×700mm
Package Dimension(包装尺寸)	698×698×750mm
Approval(证书)	CE GS CB UKCA
20" Container(20" F')	72
40" Container (high)(40" F')	144



Standard Features 标准配置

- Front top light box with decals
- Adjustable temperature controller
- Temperature Display
- Adjustable chrome plated shelf or rotated shelf
- Hinged doors at back

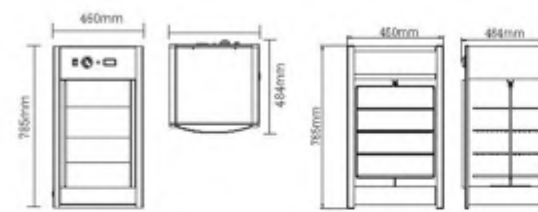

HW-97

HW-97-2

Model	HW-97	HW-97-2
Capacity-Gross(容积)	97L/2.6c.f.	97L/2.6c.f.
Temperature range(温度)	30-90°C (86-194°F)	30-90°C (86-194°F)
Rated Input Power(制热功率)	800W	800W
N.W.(净重)	22kg	22kg
G.W.(毛重)	24kg	24kg
Overall Dimension(产品尺寸)	460×484×785mm	460×484×785mm
Package Dimension(包装尺寸)	535×535×835mm	535×535×835mm
Approval(证书)	CE GS CB UKCA	CE GS CB UKCA
20" Container(20" F')	80	80
40" Container (high)(40" F')	252	252

HOT SHOWCASE

Changer Countertop Display

桌上型展示柜



Standard Features 标准配置

Stainless steel
1 hinge door
Wooden box



Standard Features 标准配置

Fixed glass shelf
Stainless steel
4 front and back hinge doors
Wooden box

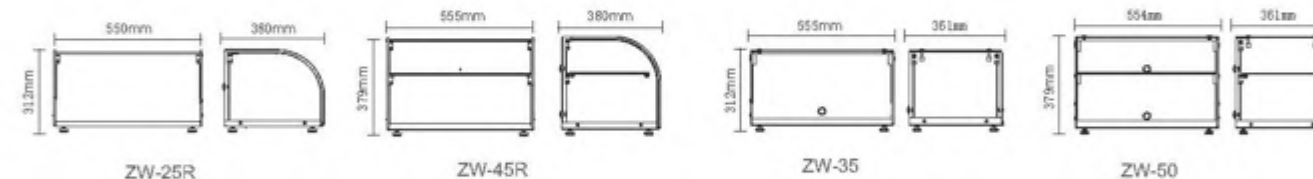

Model	ZW-25R	ZW-45R
Capacity-Gross(容积)	25L/0.8c.f.	45L/1.5c.f.
Overall Dimension(产品尺寸)	550x380x312mm	555x380x379mm
Package Dimension(包装尺寸)	610x450x370mm	610x450x440mm
N.W.(净重)	9kg	13kg
G.W.(毛重)	17kg	21kg
20" Container(20" F')	576	230
40" Container (high)(40" F')	665	570

Model	ZW-35	ZW-50
Capacity-Gross(容积)	35L/1.2c.f.	50L/1.7c.f.
Overall Dimension(产品尺寸)	555x361x312mm	554x361x379mm
Package Dimension(包装尺寸)	610x430x370mm	610x430x440mm
N.W.(净重)	9kg	13kg
G.W.(毛重)	17kg	17kg
20" Container(20" F')	234	240
40" Container (high)(40" F')	624	582

HOT SHOWCASE

Changer Countertop Display

桌上型展示柜



Standard Features 标准配置

- LED on top and under shelf
- With plates
- With light switch
- Stainless steel
- 2 hinge doors
- Wooden box

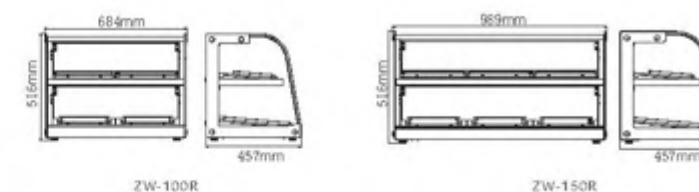

Model	ZW-100R	ZW-150R
Capacity-Gross(容积)	100L/3.5c.f.	150L/5.3c.f.
Overall Dimension(产品尺寸)	684x457x516mm	989x457x516mm
Package Dimension(包装尺寸)	725x515x590mm	1030x515x590mm
N.W.(净重)	28.5kg	37.5kg
G.W.(毛重)	40.5kg	53kg
20" Container(20" F')	105	66
40" Container (high)(40" F')	280	176